

SPECIFIC PLAN AMENDMENT 2

21-05125

April 2023

**GREEN VALLEY**  
**SPECIFIC PLAN**  
**AMENDMENT 21-05125**

SPECIFIC PLAN

89-25

"GREEN VALLEY"

ADOPTED BY  
THE PERRIS CITY COUNCIL  
MARCH 5, 1990  
RESOLUTION NO. 1781

SPECIFIC PLAN AMENDMENT 1

ADOPTED BY  
THE PERRIS CITY COUNCIL  
FEBRUARY 23, 2021  
ORDINANCE NO. 1396

SPECIFIC PLAN AMENDMENT 2

ADOPTED BY  
THE PERRIS CITY COUNCIL  
APRIL 25, 2023  
ORDINANCE NO. 1426

*Final Certified: March 5, 1990*

*Amendment 1 Certified February 23, 2021*

*Amendment 2 Certified April 25, 2023*

## **GREEN VALLEY SPECIFIC PLAN AMENDMENT 2**

*Lead Agency:*

**City of Perris**

Planning Division

135 North "D" Street

Perris, California 92370

*Project Developer:*

**Green Valley Recovery Acquisition LLC**

10421 S. Jordan Gateway, Suite 200

South Jordan, UT 84095

*Prepared By:*

**FORMA**

151 Kalmus Drive, Suite H5

Costa Mesa, California 92626

Contact Person: Gene Hsieh

## Document Updates

This document reflects all amendments to April 2023

Amendment No.	Case No.	Details of Amendment	Approval Date
1	18-05292	The purpose of Amendment No. 1 is to consolidate school sites to respond to changes in the education code, respond to the adoption of the Western Riverside County Multiple Species Habitat Conservation Plan, and adoption of the Perris Valley Airport Plan which were approved after the 1990 adoption of the Specific Plan for the southern portion of the Specific Plan area.	February 23, 2021
2	21-05125	The purpose of Amendment No. 2 is to respond to the adoption of the Western Riverside County Multiple Species Habitat Conservation Plan, adoption of the Perris Valley Airport Plan, connection to the regional trail network, and construction of the South Perris MetroLink Station, which were approved after the 1990 adoption of the Specific Plan for the northern portion of the Specific Plan area outside of the MSHCP Criteria Cells and to adjust the boundary between Planning Areas 13a and 13b.	April 25, 2023





<b>1</b>	<b>SPECIFIC PLAN SUMMARY .....</b>	<b>1-1</b>
1-1	SPECIFIC PLAN AMENDMENT 2 SUMMARY AND OBJECTIVE .....	1-1
1-2	COMMUNITY LOCATION.....	1-3
1-3	MARKET CHARACTERISTICS.....	1-3
1-4	GENERAL PLAN CONSISTENCY.....	1-6
1-5	DESIGN OBJECTIVES.....	1-7
1-6	PLAN PROCESSING.....	1-7
<b>2</b>	<b>SPECIFIC PLAN.....</b>	<b>2-1</b>
2-1	COMPREHENSIVE LAND USE PLAN .....	2-1
2.1.1	Planned Community Synopsis.....	2-1
2-2	PHASING PLAN.....	2-5
2.2.1	Introduction .....	2-5
2.2.2	Phase One .....	2-5
2.2.3	Phase Two .....	2-8
2.2.4	Development Milestones.....	2-8
2-3	COMPREHENSIVE GRADING PLAN.....	2-9
2.3.1	Grading Plan.....	2-9
2.3.2	Plan Description .....	2-9
2.3.3	Development Standards .....	2-9
2-4	DRAINAGE PLAN .....	2-9
2.4.1	Approach.....	2-9
2.4.2	Plan Description .....	2-11
2.4.3	Development Standards .....	2-11
2-5	WATER AND SEWER PLAN .....	2-14
2.5.1	Approach.....	2-14
2.5.2	Plan Description .....	2-14
2.5.3	Development Standards .....	2-15
2-6	CIRCULATION PLAN .....	2-19
2.6.1	Approach.....	2-19
2.6.2	Plan Description .....	2-19
2.6.3	Development Standards .....	2-19



<b>3</b>	<b>SPECIFIC PLAN ZONING</b>	<b>3-1</b>
3-1	R-7,200 – R-8,000 RESIDENTIAL STANDARDS	3-1
3.1.1	Permitted Uses	3-1
3.1.2	Development Standards	3-2
3-2	R-6,000 – R-7,200 RESIDENTIAL STANDARDS	3-6
3.2.1	Permitted Uses	3-6
3.2.2	Development Standards	3-7
3-3	R-5,500 – R-6,000 RESIDENTIAL ZONE	3-11
3.3.1	Permitted Uses	3-11
3.3.2	Development Standards	3-12
3-4	MULTI-FAMILY RESIDENTIAL STANDARDS	3-16
3.4.1	Permitted Uses	3-16
3.4.2	Development Standards	3-17
3-5	RETAIL COMMERCIAL STANDARDS	3-28
3.5.1	Permitted Uses	3-28
3.5.2	Prohibited Uses	3-29
3.5.3	Development Standards	3-30
3-6	BUSINESS/PROFESSIONAL STANDARDS	3-35
3.6.1	Permitted Uses	3-35
3.6.2	Prohibited Uses	3-36
3.6.3	Development Standards	3-36
3-7	LIGHT INDUSTRIAL STANDARDS	3-40
3.7.1	Permitted Uses	3-40
3.7.2	Prohibited Uses	3-40
3.7.3	Development Standards	3-40
3-8	PUBLIC FACILITIES STANDARDS	3-43
3.8.1	Permitted Uses	3-43
3.8.2	Development Standards	3-43
3-9	OPEN SPACE STANDARDS	3-45
3.9.1	Permitted Uses	3-45
3.9.2	Prohibited Uses	3-45
3-10	DEFINITIONS	3-47



<b>4</b>	<b>DESIGN GUIDELINES</b> .....	<b>4-1</b>
4-1	VISION AND INTRODUCTION .....	4-1
	4.1.1 Purpose and Objective .....	4-1
4-2	RESIDENTIAL ARCHITECTURE.....	4-2
	4.2.1 Residential Architectural Guiding Principles.....	4-2
	4.2.2 General Architectural Guidelines.....	4-3
	4.2.3 Residential Architectural Styles .....	4-18
4-3	COMMERCIAL, BUSINESS AND PROFESSIONAL, AND LIGHT INDUSTRIAL GUIDELINES .....	4-29
	4.3.1 Site Planning .....	4-29
	4.3.2 Commercial Architectural Guidelines .....	4-32
	4.3.3 Commercial/Mixed Use Design Criteria.....	4-33
	4.3.4 Lot Coverage Guidelines .....	4-34
	4.3.5 Business and Professional Architectural Guidelines.....	4-34
	4.3.6 Light Industrial Architectural Guidelines .....	4-35
4-4	LANDSCAPE PLAN .....	4-36
	4.4.1 Landscape Design Guiding Principles.....	4-36
	4.4.2 Community Design Theme/Landscape Character .....	4-38
	4.4.3 Community Identity Plan/Monumentation .....	4-41
	4.4.4 Parks .....	4-51
	4.4.5 Tot Lots/Playgrounds.....	4-64
	4.4.6 Streetscape/Circulation Plan and Sections.....	4-64
	4.4.7 Pedestrian Circulation and Trails .....	4-78
	4.4.8 Street Furniture Guidelines .....	4-80
	4.4.9 Wall and Fence Guidelines.....	4-81
	4.4.10 Utility and Equipment Screening .....	4-89
	4.4.11 Landscape Irrigation Note.....	4-89
	4.4.12 Landscape Master Community Plant Matrix .....	4-90
4-5	DESIGN REVIEW PROCESS .....	4-115
	4.5.1 Introduction .....	4-115
	4.5.2 Design Review Committee.....	4-115
	4.5.3 Compliance .....	4-115
	4.5.4 Conflicts with City Code and other Approved Entitlements or Policies .....	4-116
	4.5.5 Modifications and Amendments .....	4-116
	4.5.6 Residential Design Review Process.....	4-116
<b>5</b>	<b>APPENDIX</b> .....	<b>5-1</b>



<b>1</b>	<b>SPECIFIC PLAN SUMMARY</b>	
1-1	Regional Setting .....	1-4
1-2	Local Setting .....	1-5
<b>2</b>	<b>SPECIFIC PLAN</b>	
2-1	Conceptual Land Use Plan.....	2-3
2-2	Phasing Plan .....	2-7
2-3	Grading Plan .....	2-10
2-4	Drainage Plan .....	2-12
2-5	Swale Cross Sections: Romoland Line 'A' and San Jacinto River and Secondary Swales ...	2-13
2-6	Water Plan.....	2-16
2-7	Sewer Plan.....	2-17
2-8	Reclaimed Water Plan.....	2-18
2-9	Circulation Plan .....	2-20
2-10	Pedestrian Circulation System .....	2-21
2-10a	San Jacinto River Trail Alternative.....	2-22
2-11	Street Cross Sections.....	2-24
<b>3</b>	<b>SPECIFIC PLAN ZONING</b>	
3-1	R-7,200 – R-8,000 Residential .....	3-5
3-2	R-6,000 – R-7,200 Residential .....	3-10
3-3	R-5,500 – R-6,000 Residential .....	3-15
3-4	Multi-Family Residential .....	3-27
3-5	Commercial .....	3-34
3-6	Public Facilities and Open Space.....	3-46
<b>4</b>	<b>DESIGN GUIDELINES</b>	
4-1	Architectural Style – Spanish Colonial .....	4-20
4-2	Architectural Style – Monterey.....	4-22
4-3	Architectural Style – Craftsman .....	4-24
4-4	Architectural Style – California Wine Country .....	4-26
4-5	Architectural Style – California Prairie .....	4-28
4-6	Landscape Plan.....	4-40
4-7	Project Entry Monumentation .....	4-42
4-8	Phase I Monumentation Key Map .....	4-43
4-9	Primary Entry Monumentation – Elevation .....	4-45
4-10	Primary Entry Monumentation – Plan View .....	4-46
4-11	Neighborhood Entry Monumentation .....	4-47
4-12	Neighborhood Entry Monumentation Options .....	4-48
4-13	Community Public Park Monumentation (Per City Standards) .....	4-49
4-14	HOA Park and Trailhead Monumentation .....	4-50
4-15	Parks and Open Space Key Map.....	4-52
4-16	Phase 1 LMD & HOA Areas.....	4-53
4-17	HOA Park 1 - Tract 36989 .....	4-54



4-18 HOA Park 2 - Tract 36989 ..... 4-55  
4-19 HOA Park 3 - Tract 36989 ..... 4-56  
4-20 HOA Park – Tract 37262 ..... 4-57  
4-21 HOA Park – Tract 37223 ..... 4-58  
4-22 HOA Park– Tract 37816 ..... 4-59  
4-23 HOA Park – Tract 37817 ..... 4-60  
4-24 HOA Park 1 – Tract 37818 ..... 4-61  
4-25 HOA Park 2 – Tract 37818 ..... 4-62  
4-26 HOA Park 3 – Tract 37818 ..... 4-63  
4-27 Streetscape Section Key Map..... 4-65  
4-28 Section A - Green Valley Parkway ..... 4-66  
4-29 Section B - Fieldstone Drive ..... 4-67  
4-30 Section C - Local Street (40’ Curb to Curb) ..... 4-68  
4-31 Section D - Local Street (Side-on Lots) ..... 4-69  
4-32 Section E - Neighborhood Entry ..... 4-70  
4-33 Section A-C-E - Transition of Walks ..... 4-71  
4-34 Section F - Murrieta Road ..... 4-72  
4-35 Section G - Goetz Road ..... 4-73  
4-36 Section H – Watson Road ..... 4-74  
4-37 Bus Shelter ..... 4-75  
4-38 Section I - Channel at Ethanac Road ..... 4-76  
4-39 Section J - EMWD Landscape Buffer ..... 4-77  
4-40 Section K – San Jacinto River Trail ..... 4-79  
4-40a Section L – Loop Road ..... 4-80  
4-41 Wall and Fence Plan ..... 4-84  
4-42 Phase I Wall and Fence Plan..... 4-85

**5 APPENDIX**

5-1 Encumbrance Map ..... 5-2  
5-2 Boundary Survey ..... 5-3  
5-3 Specific Plan Zoning Exhibit..... 5-4  
5-4 Approved Master Plan of Service and Phase 1A (under separate cover) ..... 5-6  
5-5 Implementation Guidelines ..... 5-7

**TABLES**

2-1 Green Valley Phase 2 Statistical Summary ..... 2-2  
2-2 Phase One Development Plan..... 2-5  
2-3 Phase Two Development Plan ..... 2-8  
3-1 Multi-Family Development Standards ..... 3-17  
5-1 Green Valley Land Use Summary ..... 5-5



I  
S  
P  
E  
C  
I  
F  
I  
C  
  
P  
L  
A  
N  
  
S  
U  
M  
M  
A  
R  
Y



## **1 SPECIFIC PLAN SUMMARY**

### **1.1 SPECIFIC PLAN AMENDMENT 2 SUMMARY AND OBJECTIVE**

The Green Valley Specific Plan (GVSP) and EIR SCH # 8903207 were approved in 1990 for a planned community situated on approximately 1,269.2 acres with a total of 4,210 dwelling units within the City of Perris. The San Jacinto River crosses the northwest corner of the property. Interstate 215 is immediately adjacent to the property on its eastern boundary. The northeast boundary is formed by Case Road and the Metrolink 91/Perris Valley rail line, while the south and west boundaries are common to Ethanac Road and Goetz Road, respectfully.

Since the original approval, Perris Crossings has been built within the Green Valley Specific Plan (Home Depot, WinCo Foods, Starbucks, and additional restaurant and commercial uses.), and 314 single family residential dwelling units were entitled as part of Tract Maps 36988 (recorded October 4, 2019) and 36989 (recorded September 26, 2018).

Since the 1990 adoption of the Green Valley Specific Plan there have been numerous changes to State and County laws that affect the project site, including the adoption of California Education Code Section 17215 governing requirements for school siting near an airport, the adoption of the Western Riverside County Multiple Species Habitat Conservation Plan (MSHCP), the adoption of the Perris Valley Airport Land Use Compatibility Plan (ALUCP), the San Jacinto River Study, the adoption of the Romoland Master Drainage Plan, and the location of the adjacent Metrolink Station. Specific Plan Amendment 1 addressed these changes in the southern portion of the Specific Plan Area.

In 2020 California Senate Bill (SB) 330 went into effect prohibiting local jurisdictions from reducing the legal limit of housing within their borders. This requires Specific Plans to be built to their approved capacity. As part of Specific Plan Amendment 2, housing units in Phase 1 Planning Areas which were not part of the approved Tract Maps have been transferred to Phase 2 to comply with SB 330.

The primary objective of Specific Plan Amendment 1. (Case Number 18-05292) was to incorporate changes in the Specific Plan land use map resulting from development since 1990 and from the application of the laws and plans described above for the southern portion of the Specific Plan Area. These included:

- The six approved tract maps provide enough dwelling units to meet the conditions of approval previously adopted for the first two tentative maps which require dedication of land for the construction of the Regional Park;
- The Regional Park within Planning Areas 24a and 25, and an additional park adjacent to the relocated school site;
- Planning Area 16, which is part of recorded tract map 36989;
- The relocated and consolidated school site, which meets the school facility requirements for the Specific Plan;
- Planning Areas 13a – Commercial, and 13b – Multi-Family located at the intersection of Ethanac Road and Goetz Road and
- Built and approved drainage improvements.

An Addendum to the previously certified Green Valley Specific Plan Final EIR was prepared and approved which addressed project-level impacts resulting from development in the six proposed tract map areas and provided program-level analysis for the land use changes (commercial, multi-family, school and parks) outside the tract map areas.



Specific Plan Amendment 2 has been prepared to address the numerous changes to State and County laws since the 1990 adoption of the Specific Plan for the northern area of the Specific Plan Area outside of the MSHCP Criteria Cells and reflect a boundary change between Planning Areas 13a and 13b.

The primary objective of Specific Plan Amendment 2 (SPA21-05125) is to incorporate changes in the Specific Plan land use map resulting from development since 1990 and boundary change between Planning Areas 13a and 13b, and from the application of the laws and plans described above for the northern portion of the Specific Plan Area. These include:

- Provision of 1,756 dwelling units;
- Increase the residential density of the area near Case Road to take advantage of the adjacent South Perris Metrolink Station and to comply with the intent of SB 330 regarding residential development capacity;
- Update Planning Area dwelling units in the southern portion of the Specific Plan to reflect the number of units within the approved Tract Maps (update is reflected on Table 5-1 – Green Valley Land Use Summary); and
- Reflect a boundary change between Planning Area 13a and 13b, increasing the size of PA 13a by 0.3 acres and decreasing PA 13b by 0.3 acres. Due to the reduction in size of PA 13b, the number of dwelling units is reduced from 135 to 111. The 24 unused units are transferred to PA 30.

Addendum 3 to the previously certified Green Valley Specific Plan Final EIR has been prepared which addresses land use changes and impacts resulting from development in the Phase 2 development area

At this time there are no further amendments proposed within the northern portion of the Green Valley Specific Plan within the MSHCP Criteria Cells, as there are no specific development proposals for that portion and substantially more planning is needed to determine how the remainder of the Specific Plan Area's future land uses will need to be modified to achieve consistency with the MSHCP, the 2011 adopted Perris Valley ALUCP, floodplain regulations, and SB 330 (concerning changes to existing plans and zones providing for residential development capacity). Given the extensive agency consultations that may be required to develop a set of potentially feasible land use map revisions for consideration, this further process may take several more years, during which time, no tentative tract maps would be considered in the areas in the Specific Plan that are not covered under the currently proposed and approved tract maps and Specific Plan Amendments 1 and 2 until that further planning is completed and analyzed, including subsequent environmental review under CEQA to consider whether new or more severe significant impacts would result from those changes. At this time, it would be premature to consider making any changes to those areas within the MSHCP Criteria Cells of the Specific Plan land use map since environmental and economic conditions are likely to change further before any specific development proposals are offered, and any assumptions about development in the northern portion would be merely hypothetical.





**1.2 COMMUNITY LOCATION**

The Green Valley site is situated south of Case Road and north of Ethanac Road, between Goetz Road and Interstate 215. It is located approximately four miles southeast of the Perris City Hall. The property is illustrated on Figure 1-1, Regional Setting, and Figure 1-2, Local Setting.

**1.3 MARKET CHARACTERISTICS**

The Green Valley Specific Plan Amendment 2 Area will be completed with multiple residential products and related uses. The diversity of product types is intended to stimulate the creation of a planned community for singles and families, both first-time homeowners and, more predominantly, move-up buyers. There is also a local demand for attached products and apartments. Commercial uses are proposed at the intersection of Murrieta Road and Case Road and at Ethanac Road and Goetz Road. This commercial center, along with the existing commercial uses at Perris Crossings provide a variety of commercial and retail opportunities for Green Valley and Perris residents.

The inclusion of a school, parks and open space within the planned community is considered desirable within the Perris area market. Such common areas, along with streetscapes are proposed to be dedicated to the City of Perris, but maintained through Landscape Maintenance Districts (LMDs), for the use by Green Valley and other City of Perris residents, alike.

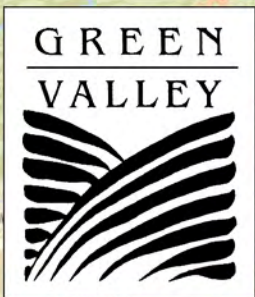
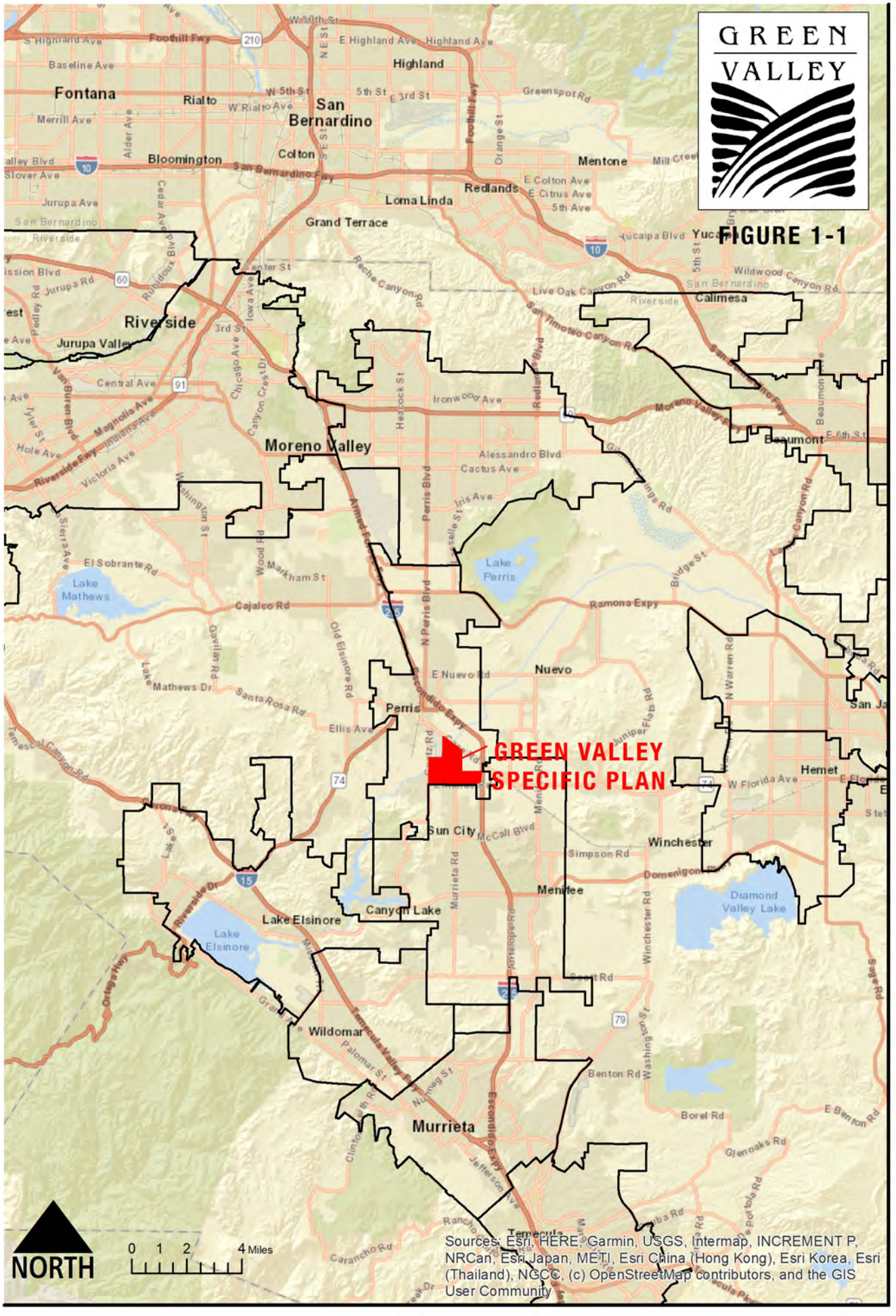


FIGURE 1-1



GREEN VALLEY  
SPECIFIC PLAN



0 1 2 4 Miles

Sources: Esri, HERE, Garmin, USGS, Intermap, INCREMENT P, NRCan, Esri Japan, METI, Esri China (Hong Kong), Esri Korea, Esri (Thailand), NGCC, (c) OpenStreetMap contributors, and the GIS User Community



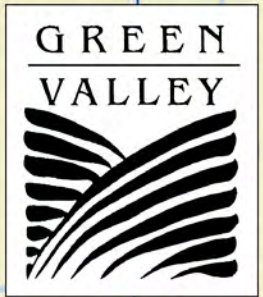
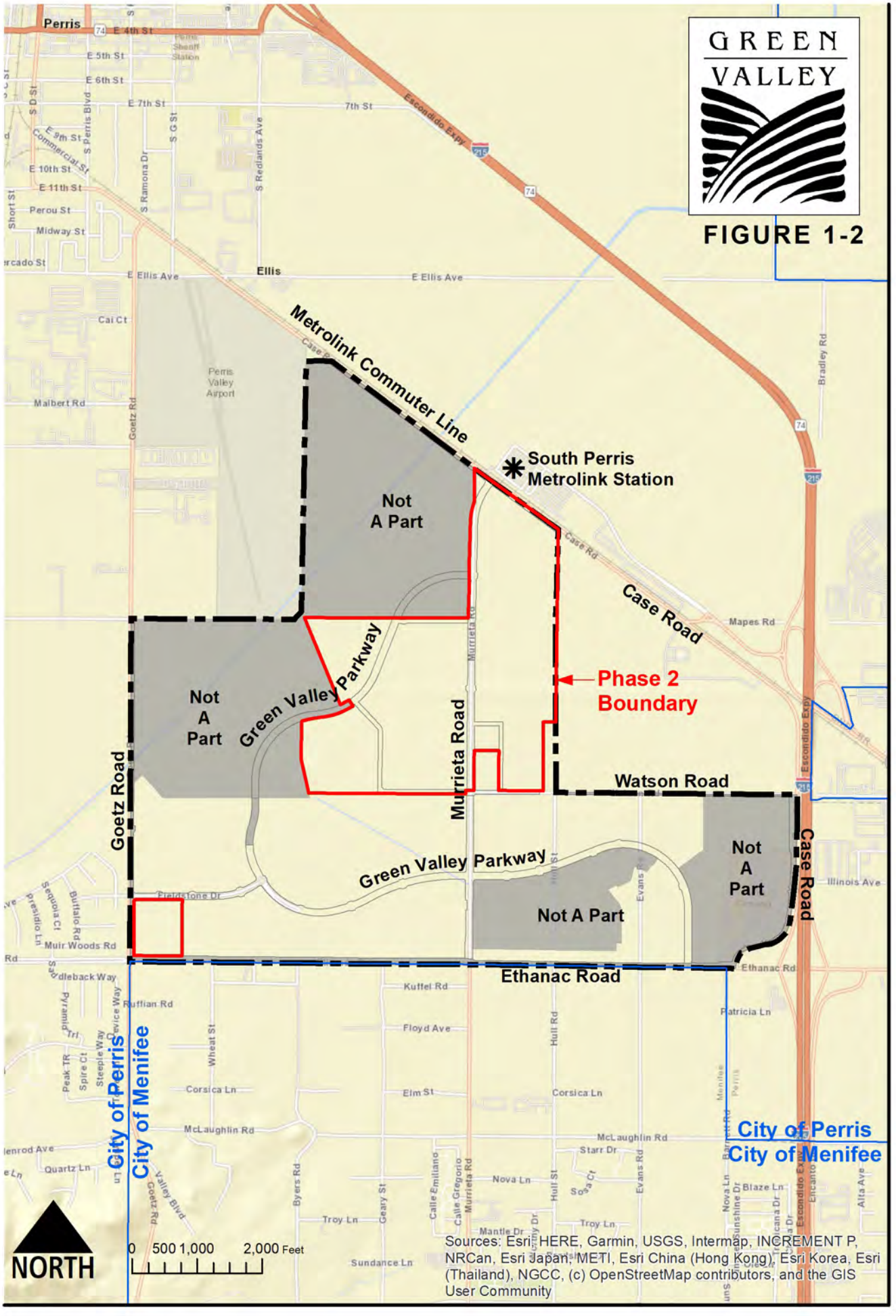


FIGURE 1-2



Sources: Esri, HERE, Garmin, USGS, Intermap, INCREMENT P, NRCan, Esri Japan, METI, Esri China (Hong Kong), Esri Korea, Esri (Thailand), NGCC, (c) OpenStreetMap contributors, and the GIS User Community



#### **1.4 GENERAL PLAN CONSISTENCY**

Green Valley Specific Plan is located in Planning Area 8 in the General Plan. As characterized in the City of Perris General Plan (2030) there are key elements in PA 8 that affect the planning of Green Valley: Perris Airport, San Jacinto River and the Western Riverside County MSHCP areas.

##### **1.4.1 Balanced Land Uses**

In responding to the constraints and restrictions of the Airport, San Jacinto River and the Western Riverside County MSHCP, the project has reduced the acres previously designated residential. This has greatly increased the amount of open space and parks. The residential density has increased to take advantage of the proximity to park, school, open space, and the South Perris, Metrolink Station, still providing a range of housing types from traditional single-family, single-family court, townhomes, and apartments. The amount of park provided within the entire Specific Plan Area is greatly in excess of the amount of park required. Commercial uses are located at roadway intersections to provide a variety of neighborhood-level commercial and retail opportunities.

##### **1.4.2 Regional Circulation**

Green Valley Specific Plan Amendment 2 implements the General Plan Circulation with the extension of Murrieta Road north of Ethanac Road to Case Road and a portion of Green Valley Parkway. Murrieta Road extends beyond Ethanac Road south into the City of Menifee.

##### **1.4.3 Open Space and Park**

The General Plan does not designate any park and open space for PA 8. The Green Valley Specific Plan Amendment 2 adds regional open space. The plan provides 43.0 acres of Open Space and 6.7 acres of parks in addition to the 35.65-acre regional park approved in Amendment 1.

##### **1.4.4 Conservation and Sustainability**

To conserve water, Green Valley will have a dual system to provide potable water and reclaimed water for landscaping. In addition, the landscape palette is designed to be low water use or drought-tolerant to reduce water usage. Location of neighborhood commercial and extensive parks, trails and recreational system within the entire Green Valley Residential Community will help reduce vehicle miles travelled, therefore reducing greenhouse gas emissions.

##### **1.4.5 Complete Community**

In meeting the Goals and Objectives of the City of Perris General Plan, Green Valley is a complete community providing a variety of homes responding to different lifestyles, providing new commercial and employment areas, in addition to the existing commercial and business centers. The overall Specific Plan provides a full array of private recreation facilities, neighborhood parks, a regional park, school, community and regional trails, and community and regional open space. A comprehensive Design Guidelines Chapter is provided in the Specific Plan to ensure that the Green Valley Community is a quality place to live, work and play.



### **1.5 DESIGN OBJECTIVES**

The Green Valley Specific Plan Amendment 2 has been designed to respond to the demand for a mixed residential, commercial and recreational theme oriented planned community. The objectives of design include the exclusive use of public streets, public parks of size, area and development consistent with the State of California Quimby Act (five acres per 1,000 population) and City of Perris Resolution no. 5141, a diverse but fiscally responsive distribution of land uses. Other design features of note include:

- The creation of a regional park on 35.65 acres on all of Planning Area 25 and a portion of Planning Area 24a.
- Taking advantage of the adjacent South Perris Metrolink Station by providing commercial and multi-family uses within walking distance of the regional transportation center.
- The use of thematic entryways and streetscapes for community image along the backbone roadway and loop roads in addition to giving identity at neighborhood and secondary entries.
- The placement of a local public park adjacent to the elementary school site and Multi-Family Planning Area.
- The use of wide grassy swales for seasonal drainage during wet periods and landscape swales during dry seasons.
- The creation of a Landscape Maintenance District (LMD) to finance the maintenance of public parks and improvements without using general fund tax sources.
- The creation of a curvilinear collector circulation system to assist in reducing through traffic speeds, create a hierarchy of function and design, and to create a continually varying streetscape.
- The provision of 1,756 dwelling units in Phase 2 of a variety of densities and product type to help meet the residential demand of Perris and the Inland Empire.

The residential component is designed to establish small enclaves, or planning areas, each serving as a separate neighborhood unit. Each planning area is intended to be built around cohesive design treatments giving identity and providing for architectural unity.

### **1.6 PLAN PROCESSING**

The Specific Plan Amendment must be reviewed and acted upon in advertised public hearings before both the City of Perris Planning Commission and City Council. The Planning Commission makes recommendations to the City Council, who is the formal approving body. The Specific Plan complies with the provisions of the California Environmental Quality Act (CEQA). An Environmental Impact Report (State Clearinghouse Number 1989032707) under the direction of the City of Perris Planning Department was prepared and certified in 1990. An addendum is appropriate where a previously certified EIR has been prepared and some changes or revisions to the project are proposed, or the circumstances surrounding the project have changed, but none of the changes or revisions would result in significant new or substantially more severe environmental impacts, consistent with CEQA Section 21166 and State CEQA Guidelines Sections 15162, 15163, 15164, and 15168. The addendum is intended to evaluate and confirm CEQA compliance for proposed amendments to the GVSP, which would be a change relative to what is described and evaluated in the 1990 GVSP Final EIR and 2017 and 2020 GVSP Addenda.



2  
S  
P  
E  
C  
I  
F  
I  
C  
P  
L  
A  
N



## 2 SPECIFIC PLAN

### 2.1 COMPREHENSIVE LAND USE PLAN

#### 2.1.1 Planned Community Synopsis

Green Valley Specific Plan Amendment 1 provided for development of the 360.5 acres consisting of 211.9 acres of residential, 5.5 acres of commercial, 64.1 acres of public parks, a 15.0 acre public school site, and 64.0 acres of open space land uses. Amendment 2 provides for the development of 274.4 acres consisting of 177.0 acres of residential, 6.9 acres of commercial, 6.7 acres of public park, a 15.0 acre public school site, 25.8 acres of roadways, and 43.0 acres of open space land uses. The mix of land uses proposed in the Green Valley community will serve to create a dynamic full-service community with residents, shopping and recreation areas closely linked together, thereby reducing the need to commute out of the area, with all the inherent environmental and safety implications. The commercial and the majority of the residential uses are located near the South Perris Metrolink Station. The planned community approach to development assures the project will function properly in respect to land use, circulation, drainage, and water and sewer issues. A comprehensive master plan, such as proposed in the Green Valley Specific Plan, provides the opportunity to create unifying design themes in the land use distribution through implementation of common streetscape and landscape elements, fencing and wall designs, colors and textures, cohesive signage, common architectural objectives and appropriately scaled street furnishings.

The community has been designed to be consistent with local and state plans, policies and programs. Public parks and the school site are proposed in quantity, location, and configuration that meet or exceed requirements by the respective agencies. Similarly, all streets are proposed to be publicly dedicated and maintained by the City of Perris. LMDs will be responsible for maintenance of the public parks, the parkways and medians, the greenbelt swales, and the special entry landscape features.

The Green Valley Specific Plan Amendment 2 proposed distribution of land uses are summarized by use and planning area on Table 2-1, Green Valley Statistical Summary. This Statistical Summary contains the proposed uses, acres, residential densities, and dwelling units for each Planning Area.



[Table 2-1 Green Valley Phase 2 Statistical Summary]

LAND USE	PLANNING AREA NO.	ACRES	EXISTING DUs	PROPOSED DUs	DU/AC	% OF TOTAL
<b>Single Family Residential</b>						
6,000 - 7,200 S.F.						
	19a	23.4	111	110	4.7	8.1
5,500 – 6,000						
	6a	16.7	87	77	4.6	5.8
	20	28.1	146	130	4.6	9.7
	21	27.5	156	145	5.3	9.5
Single Family Subtotal		95.7	500	462	4.8	33.1
<b>Multi-family Residential</b>						
	13b	8.7	135	111	12.8	3.0
	30	81.3	184	1,183	14.5	28.1
Residential Subtotal		185.7	819	1,756	9.4	64.2
<b>Parks</b>						
	33	6.7				2.3
<b>School</b>						
	32a	15.0				5.2
<b>Open Space</b>						
	6b	7.9				2.7
	22a	31.7				11.0
	57a	3.4				1.2
Subtotal		43.0				14.9
<b>Commercial</b>						
	3a	1.0				0.3
	13a	5.4				1.9
	29	5.9				2.0
Subtotal		12.3				4.3
<b>Circulation</b>		26.5				9.2
<b>PROJECT TOTAL</b>		<b>289.2</b>	<b>819</b>	<b>1,756</b>	<b>6.1</b>	<b>100%</b>



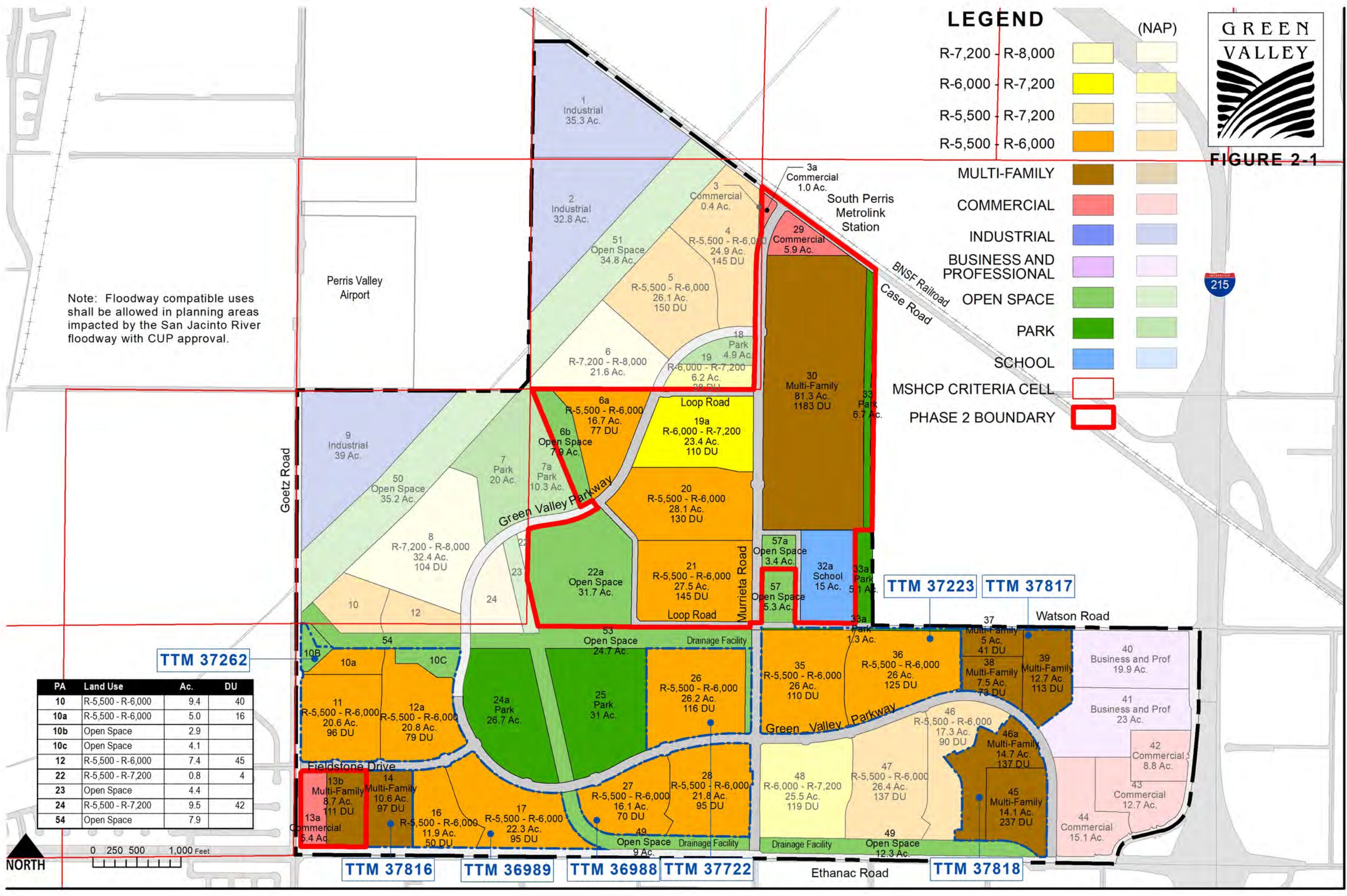


FIGURE 2-1

**LEGEND**

R-7,200 - R-8,000	(NAP)
R-6,000 - R-7,200	
R-5,500 - R-7,200	
R-5,500 - R-6,000	
MULTI-FAMILY	
COMMERCIAL	
INDUSTRIAL	
BUSINESS AND PROFESSIONAL	
OPEN SPACE	
PARK	
SCHOOL	
MSHCP CRITERIA CELL	
PHASE 2 BOUNDARY	

Note: Floodway compatible uses shall be allowed in planning areas impacted by the San Jacinto River floodway with CUP approval.



PA	Land Use	Ac.	DU
10	R-5,500 - R-6,000	9.4	40
10a	R-5,500 - R-6,000	5.0	16
10b	Open Space	2.9	
10c	Open Space	4.1	
12	R-5,500 - R-6,000	7.4	45
22	R-5,500 - R-7,200	0.8	4
23	Open Space	4.4	
24	R-5,500 - R-7,200	9.5	42
54	Open Space	7.9	





Planning area boundaries shown on the Conceptual Land Use Plan may be modified with the approval of the City of Perris, Director of Development Services. Such approval may be granted administratively upon review of a written request accompanying a tentative tract map submittal. The total number of dwelling units allowed within each planning area can exceed that allowed by the Specific Plan Statistical Summary up to twenty percent (20%) provided the cumulative total of 4,210 dwellings is not exceeded. This policy allows the transfer of dwelling units and associated land-use designations among planning areas while maintaining control of the maximum dwellings permitted in the planned community. Area modifications and density transfers are contingent upon the master developer providing data to verify, prior to tentative tract map approval, that the infrastructure capacity will be adequate to support the development proposal.

Commercial uses are existing at the intersection of Ethanac Road and Interstate 215 - Perris Crossing, which includes Home Depot, WinCo Foods, Starbucks, and additional restaurant and commercial uses and total 36.6 acres. A 5.8-acre local commercial enclave is proposed at the intersection of Ethanac and Goetz Roads to serve neighborhood shopping needs and was approved in GVSP Amendment 1 and is increased by 1.6 acres in Amendment 2. Phase 2 also proposes 6.9 acres of commercial at the northeasterly intersection of Murrieta Road at Case Road. The commercially designated parcels in these locations account for 49.0 acres of mixed commercial shopping and take advantage of their arterial roadway locations, accessibility to the freeway, South Perris Metrolink Station, and high visibility settings.



**2.2 PHASING PLAN**

**2.2.1 Introduction**

Due to the cost of constructing public improvements and the realities of land use absorption rates of the market plan, phasing of development is a practical necessity. The approach to phasing employed for the Green Valley Specific Plan Amendment is to create a distribution of land uses in each phase served by an appropriate infrastructure network and public improvements in reasonable balance to the population of the respective phase. Phases may run concurrently and overlap. The overall phasing program is illustrated on Figure 2-2.

**2.2.2 Phase One**

Phase One is located between Goetz Road and Case Road with the southern boundary being Ethanac Road and the northern boundary Watson Road and the drainage channel west of Murrieta Road. Currently built outside this Amendment is Perris Crossing commercial center at Ethanac Road and Case Road. Approved Phase One Tract Maps are 36988, 37223, 37262, 37722, 37816, 37817, and 37818. The units within Planning Areas 46, 47, and 48 are not a part of this Amendment.

Proposed uses within Phase One include single family and multi-family residential, the Regional Park, and a community commercial site at Goetz Road and Ethanac Road as detailed in Table 2-2. The Green Valley Specific Plan is being built out with the backbone drainage component and all the Ethanac Road half-street improvements in the first phase. This phase also includes the full street improvements of Green Valley Parkway from the vehicular roadway in Tract 37262 in Planning Area 12 to Ethanac Road, half-street improvements for Goetz Road from Ethanac Road to the San Jacinto River and for the full width of Murrieta Road to Watson Road. The improvements of the San Jacinto River right-of-way will coincide with the phasing plan of Riverside County Flood Control. All infrastructure improvements (roadway, water, sewer, and drainage) within Phase One will be completed during Phase One.

[Table 2-2 Phase One Development Plan]

<b>Land Use</b>	<b>DUs</b>	<b>Acres</b>
R-7,200 – R-8,000 Residential	-	-
R-6,000 – R-7,200 Residential	-	-
R-5,500 – R-6,000 Residential	852	196.7
Multi-family Residential	833	73.9
School	-	-
Parks	-	62.8
Commercial	-	5.5
Business and Professional	-	-



Industrial	-	-
Open Space	-	66.2
Roads/Infrastructure	-	56.4
<b>TOTAL</b>	<b>1,685</b>	<b>461.5</b>

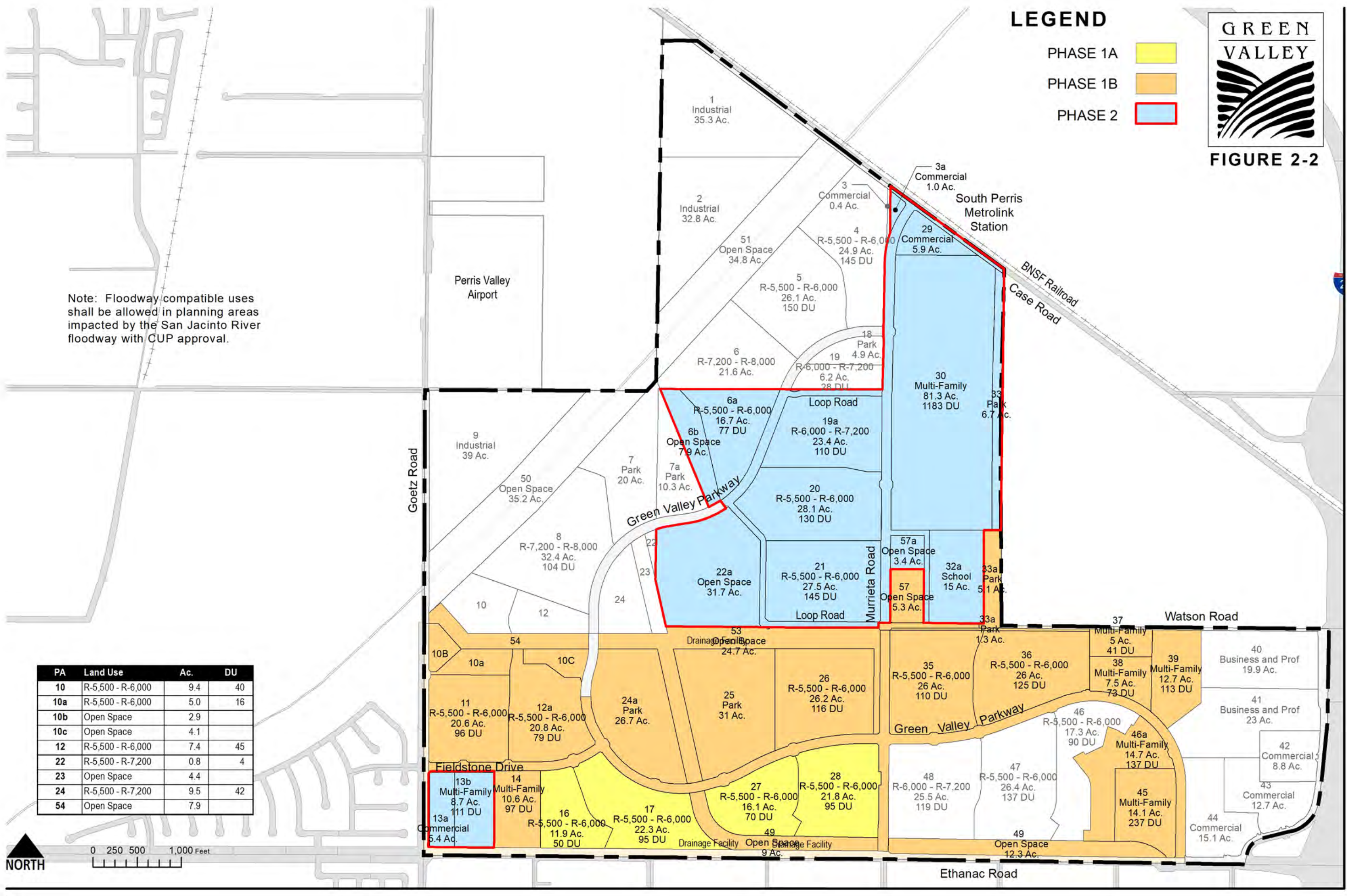


FIGURE 2-2

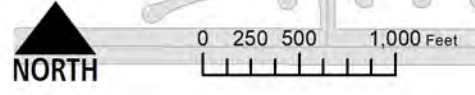
**LEGEND**

- PHASE 1A
- PHASE 1B
- PHASE 2

Note: Floodway compatible uses shall be allowed in planning areas impacted by the San Jacinto River floodway with CUP approval.



PA	Land Use	Ac.	DU
10	R-5,500 - R-6,000	9.4	40
10a	R-5,500 - R-6,000	5.0	16
10b	Open Space	2.9	
10c	Open Space	4.1	
12	R-5,500 - R-6,000	7.4	45
22	R-5,500 - R-7,200	0.8	4
23	Open Space	4.4	
24	R-5,500 - R-7,200	9.5	42
54	Open Space	7.9	





**2.2.3 Phase Two**

Phase Two is generally located north of Watson Road, east of Murrieta Road, and west of the EMWD Perris Valley Regional Water Reclamation Facility. The second phase of development includes the school site, and park and open space uses. The distribution of uses for Phase Two are summarized in Table 2-3. Phase Two requires less infrastructure and perimeter circulation improvements in support of development than installed in Phase One. Such improvements are limited to full street improvements of Murrieta Road, Loop Road, a portion of Green Valley Parkway, and Case Road. All infrastructure improvements (roadway, water, sewer, and drainage) within Phase Two will be completed during Phase Two.

[Table 2-3 Phase Two Development Plan]

Land Use	DUs	Acres
R-7,200 – R-8,000 Residential	-	-
R-6,000 – R-7,200 Residential	110	23.4
R-5,500 – R-6,000 Residential	352	72.3
Multi-family Residential	1,294	90.0
School (1 site)	-	15.0
Parks	-	6.7
Commercial	-	12.3
Industrial	-	-
Open Space	-	43.0
Roads/Infrastructure	-	26.5
<b>TOTAL</b>	<b>1,756</b>	<b>289.2</b>

**2.2.4 Development Milestones**

It is customary to establish development milestones for phasing in concert with the review and conditions establishment for the master tentative tract maps.

Ensuing planning may dictate the need for alternative development phasing scenarios for infrastructure construction and associated development phasing. This may result from changes in regional and local plans, including but not limited to airport operations, changes to the MSHCP, changes to regional water and reclaimed water master plans, and regional sewer plans. Should this occur, an alternative phasing plan would be filed pursuant to the requirements in P.M.C. 19.54 (Authority and Review Procedures



## 2.3 COMPREHENSIVE GRADING PLAN

### 2.3.1 Grading Plan

Green Valley is located on a relatively flat area. Grading for the proposed site is designed to provide a balanced cut and fill situation to prevent the need for import or export of dirt while allowing adequate drainage of the site. Please refer to the Environmental Impact Report for cut/fill cubic yardage calculations.

### 2.3.2 Plan Description

Grading as proposed will result in a balanced earthwork situation, and is designed to facilitate drainage from the site into the planned storm facilities and remove areas from the 100-year flood plain, refer to Figure 2-3, Grading Plan. Grading will be phased to coincide with each phase of development. It may be necessary, however, to "borrow" or "loan" dirt from one phase to another within the project as construction proceeds. More precise grading to be provided by future Tentative Tract maps.

### 2.3.3 Development Standards

All grading is subject to the City of Perris policies and guidelines.

## 2.4 DRAINAGE PLAN

### 2.4.1 Approach

In the undeveloped state, the Green Valley site is subject to inundation by the 100-year storm runoff from two drainage areas: the San Jacinto River Basin and the Romoland Wash. The Riverside County Flood Control and Water Conservation District discusses plans for channeling storm flow for the San Jacinto River Basin in its *Master Drainage Plan for the San Jacinto River*<sup>1</sup>. These plans include the San Jacinto Storm Drain Channel, which transects the northwestern portion of the project site.

Improvements to the San Jacinto River will be capable of containing the anticipated peak storm flow of approximately 11,000 cubic feet per second (cfs). Improvements necessary to protect lands within the Romoland Wash are discussed in the *Homeland/Romoland Area Drainage Plan*<sup>2</sup>. One of these improvements, Romoland Line 'A', is located along the southerly boundary of the Specific Plan Area and is designed to contain anticipated peak flows of approximately 5,250 cfs.

<sup>1</sup> Riverside County Flood Control and Water Conservation District, 1974.

<sup>2</sup> Riverside County Flood Control and Water Conservation District, 1988.





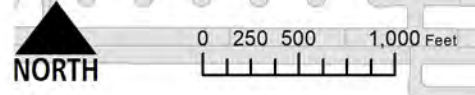
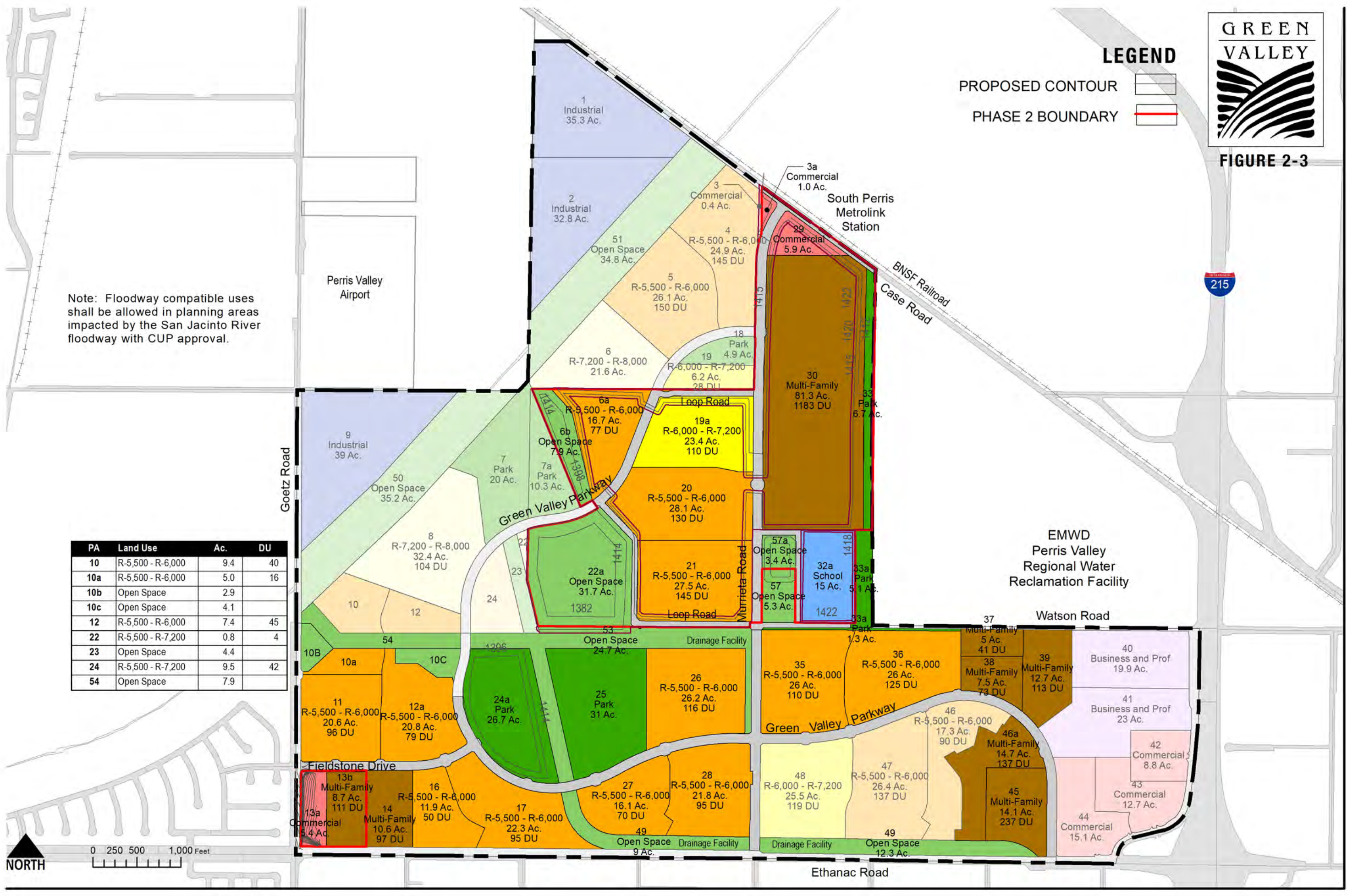
FIGURE 2-3

**LEGEND**

- PROPOSED CONTOUR
- PHASE 2 BOUNDARY

Note: Floodway compatible uses shall be allowed in planning areas impacted by the San Jacinto River floodway with CUP approval.

PA	Land Use	Ac.	DU
10	R-5,500 - R-6,000	9.4	40
10a	R-5,500 - R-6,000	5.0	16
10b	Open Space	2.9	
10c	Open Space	4.1	
12	R-5,500 - R-6,000	7.4	45
22	R-5,500 - R-7,200	0.8	4
23	Open Space	4.4	
24	R-5,500 - R-7,200	9.5	42
54	Open Space	7.9	







The Green Valley project also proposes the construction of several secondary open drainage swales which will carry storm surface water on-site both to the Romoland Line 'A' and the San Jacinto River channel.

It is important to note that the Romoland Line 'A' and all proposed secondary swales will be improved with appropriate landscape treatments which will allow limited recreational use during non-storm periods. Improvements such as turf, plants and concrete nuisance flow ribbons will be constructed in a manner which does not interfere with storm drainage functions, but which offers some aesthetic and recreational value.

Green Valley is within the San Jacinto River Improvement District 4-2, and has been assessed a fee by the County for the design and construction of the San Jacinto Storm Drain Channel. Construction of the channel by the District, will remove the project site from the 100-year floodplain of the San Jacinto River. At this time, the design of the San Jacinto River Channel anticipates that, of the total flood control right-of-way, approximately 100 feet will contain an enhanced riparian /wildlife corridor, which will run the length of the channel. The property owner is also a participant in the pending Assessment District No. 4-4, which will provide the funding necessary for the construction of Romoland Line 'A'.

During the review process, a study moratorium area was established temporarily prohibiting development within a 750-foot wide cross-section of the San Jacinto River. This 750-foot wide corridor has been respected during the design process. The specific plan designates the area of this zone outside the 450' R.C.F.C.D. R.O.W. as a study area. Tentative maps denote this area as reserved for future development, with the concurrence of the City of Perris.

#### **2.4.2 Plan Description**

The drainage plan for Green Valley (Figure 2-4) presents the storm drain improvements necessary for flood control on the project site. Elements of the drainage system include:

- The project proponent is proposing to finance and construct the San Jacinto Channel and Romoland Line 'A' by the Riverside County Flood Control and Water Conservation District. The Green Valley drainage plan proposes to relocate a portion of Line 'A'. This realignment would allow runoff water to be channelized along greenbelt swales rather than across proposed private lots. Cross sections of these swales are illustrated on Figure 2-5.
- Construction of approximately 17,900 lineal feet of secondary swales which will have a capacity of approximately 50 to 150 cubic feet per second (cfs) at a slope of 0.2 percent. These secondary swales are needed to channel runoff from the project site, due to the topography of the site.

#### **2.4.3 Development Standards**

- The project proponent will cooperate with the Riverside County Flood Control District and the City of Perris to have Flood Insurance Maps amended to reflect the improved condition of channels.
- The Green Valley project will be consistent with all approved County Drainage Master Plans.





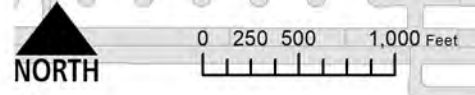
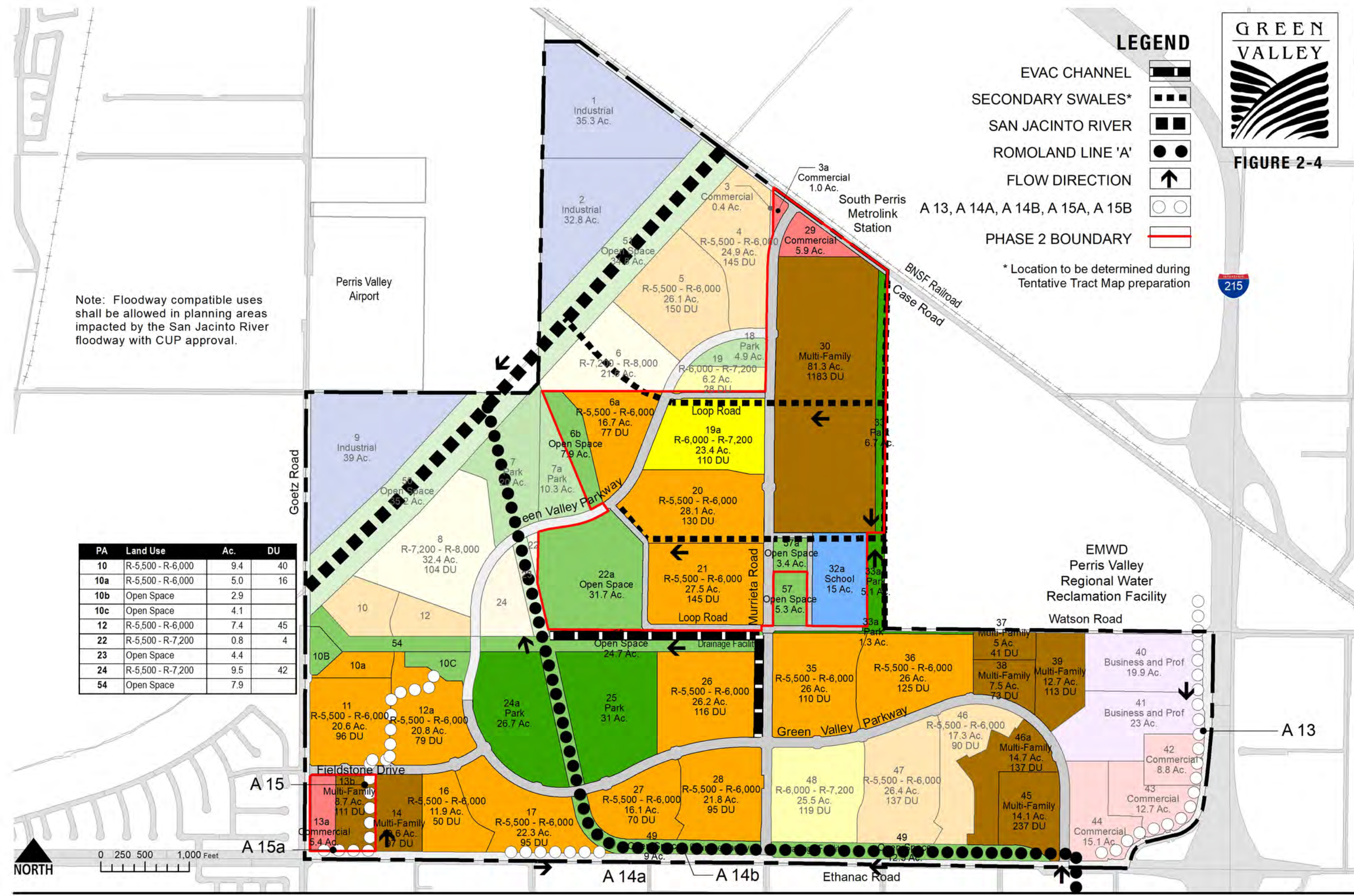
FIGURE 2-4

**LEGEND**

- EVAC CHANNEL
  - SECONDARY SWALES\*
  - SAN JACINTO RIVER
  - ROMOLAND LINE 'A'
  - FLOW DIRECTION
  - A 13, A 14A, A 14B, A 15A, A 15B
  - PHASE 2 BOUNDARY
- \* Location to be determined during Tentative Tract Map preparation

Note: Floodway compatible uses shall be allowed in planning areas impacted by the San Jacinto River floodway with CUP approval.

PA	Land Use	Ac.	DU
10	R-5,500 - R-6,000	9.4	40
10a	R-5,500 - R-6,000	5.0	16
10b	Open Space	2.9	
10c	Open Space	4.1	
12	R-5,500 - R-6,000	7.4	45
22	R-5,500 - R-7,200	0.8	4
23	Open Space	4.4	
24	R-5,500 - R-7,200	9.5	42
54	Open Space	7.9	



A 15  
A 15a

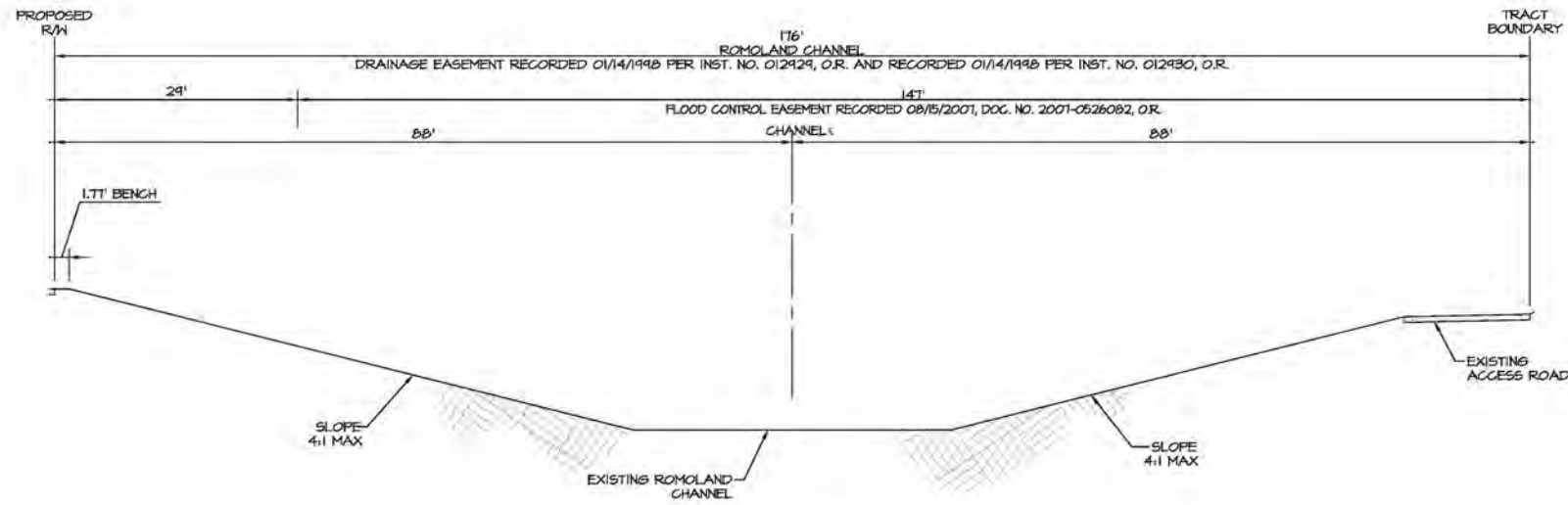
A 14a A 14b

A 13

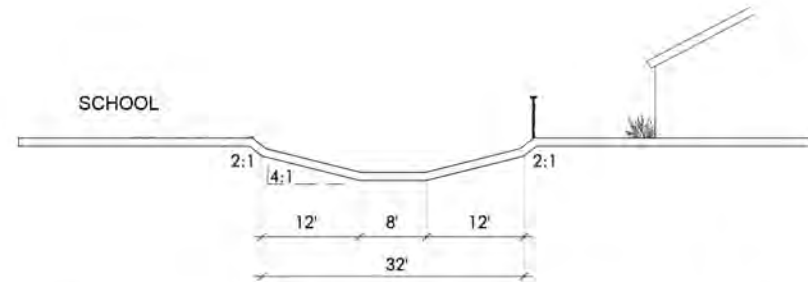




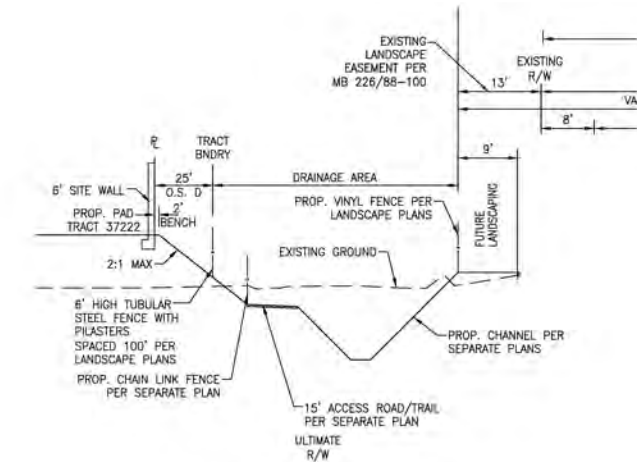
FIGURE 2-5



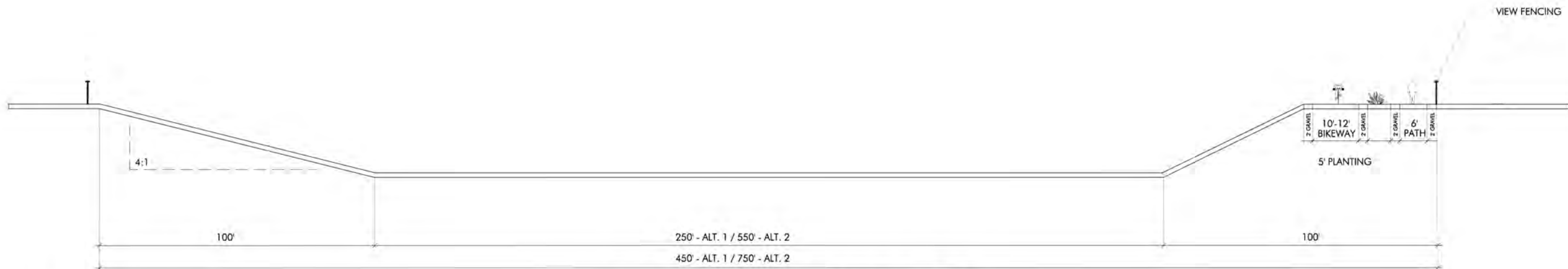
**ROMOLAND CHANNEL "A"**  
(176' R.O.W.)



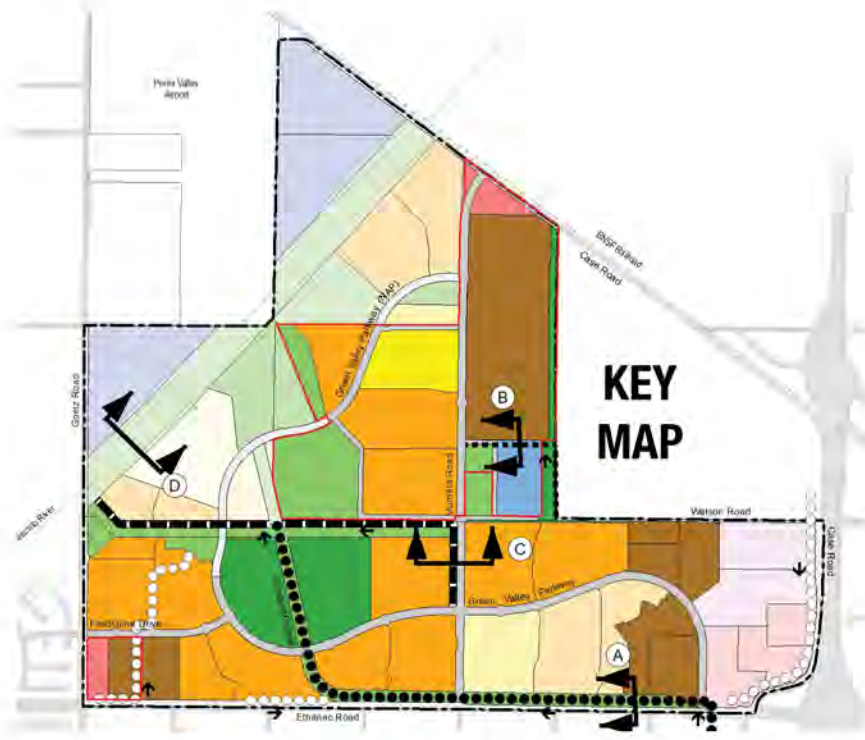
**SECONDARY SWALE CONDITION "B"**  
(32' R.O.W.)



**EVAC. CHANNEL "C"**  
(32' R.O.W.)



**SAN JACINTO RIVER CONDITION "D"**  
(450' R.O.W. - ALT. 1 / 750' R.O.W. - ALT. 2)



**KEY MAP**





Standards will be used in the detailed engineering design of the Green Valley storm drain system so that proposed facilities will protect the homes, school, commercial, and industrial areas of the community while meeting the requirements of the City of Perris and the Riverside County Flood Control and Water Conservation District.

No improvements to any drainage facility will be made by the project proponent which serve to alter or restrict the drainage functions of drainage facilities.

Maintenance of the EVAC Channel and all other drainage facilities, except the San Jacinto River channel, will be the responsibility of Riverside County Flood Control.

All drainage swales will be bordered by appropriate walls or fences. In areas where views are to be accentuated, view fencing will be used. In areas where views are to be screened, theme walls will be used.

## **2.5 WATER AND SEWER PLAN**

### **2.5.1 Approach**

Eastern Municipal Water District (EMWD) is the public agency purveyor for both water and sewer service for the Green Valley Specific Plan Area. EMWD prepared a Water Supply Assessment Report in April 2022 for Green Valley Specific Plan – Phase 2. This report concluded that the District has adequate potable water, recycled water, and sewer capacity for Green Valley Specific Plan – Phase 2.

**Water:** Figure 2-6 illustrates the water plan for Green Valley. The project site is within the 1627 service zone of EMWD. Waterlines exist in the vicinity of the property as follows:

- Murrieta Road 8-18-inch diameter line
- Goetz Road (southern portion) 12-inch diameter line
- Goetz Road (northern portion) 8-inch diameter line

In addition, a temporary booster station currently exists just west of Murrieta Road, south of Green Valley Parkway. This booster station is being phased out and replaced with a permanent station west of Murrieta Road and north of Watson Road.

**Sewer:** Figure 2-7 illustrates the sewer plan for Green Valley. EMWD's Perris Valley Treatment Plant is located northeast of the project site between the project boundary and Case Road. A 24-inch diameter sewer line is located in Case Road adjacent to the northern boundary of the project site, and an 18-inch diameter sewer line runs through the site in Evans Road. An EMWD lift station is proposed south of Fieldstone Drive, approximately 400 feet west of Goetz Road.

**Reclaimed Wastewater:** Figure 2-8 illustrates the reclaimed wastewater plan for Green Valley. The sources of supply shall be obtained from Eastern Municipal Water District's Perris Valley Treatment Plant, which is located northeast of the project site. Residential development adjacent to this Treatment Plant shall provide disclosures to future homeowners of the proximity to the facility and potential odors.

### **2.5.2 Plan Description**

**Water:** The Green Valley community will connect with the existing waterlines at the project site. An internal loop system of 12-27-inch waterlines is proposed for the majority of the site.

Eastern Municipal Water District has approved a master water plan.



**Sewer:** Facilities to serve the project include:

- A lift station to a force main for areas in the southwest portion of Green Valley; and,
- A system of 8-inch, 10-inch, 12-inch, 15-inch, 18-inch, 30-inch and 48-inch diameter sewer lines throughout the Green Valley project.

The proposed sewer lines will connect to the existing sewer lines at the project site. The wastewater collected on the project site will be discharged into the Perris Valley Treatment Plant. Eastern Municipal Water District is currently in the process of preparing a master sewer plan.

**Reclaimed Wastewater:** It is anticipated that reclaimed wastewater will be used for the maintenance of parks, medians, schools and open space areas within the project area. Facilities to serve the project include the installation of approximately 46,000 linear feet of 8-18-inch pipeline. The source of supply will originate from a proposed 1,627-foot Eastern Municipal Water District wastewater service zone. This service zone has not been established by EMWD as of this date. Therefore, the installation of a ground storage reservoir and booster pump facilities may be required to provide the necessary operating pressure to irrigate the project site. The Reclaimed Water Plan is illustrated on Figure 2-8.

### 2.5.3 Development Standards

The water distribution, wastewater collection, and reclaimed wastewater distribution systems will be designed so that the proposed facilities will be adequately sized to meet the requirements of Green Valley development, while meeting the requirements of the Eastern Municipal Water District and the City of Perris. These facilities will be installed in accordance with the requirements and specifications of the Riverside County Health Department. Cost for the capital facilities will be financed with private financing by the developer.





FIGURE 2-6

**LEGEND**

- PROPOSED WATERLINE
- EXISTING WATERLINE
- PROPOSED PERMANENT BOOSTER
- EXISTING TEMPORARY BOOSTER
- PIPE SIZES
- PHASE 2 BOUNDARY

Note: Floodway compatible uses shall be allowed in planning areas impacted by the San Jacinto River floodway with CUP approval.

PA	Land Use	Ac.	DU
10	R-5,500 - R-6,000	9.4	40
10a	R-5,500 - R-6,000	5.0	16
10b	Open Space	2.9	
10c	Open Space	4.1	
12	R-5,500 - R-6,000	7.4	45
22	R-5,500 - R-7,200	0.8	4
23	Open Space	4.4	
24	R-5,500 - R-7,200	9.5	42
54	Open Space	7.9	

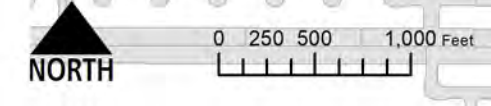
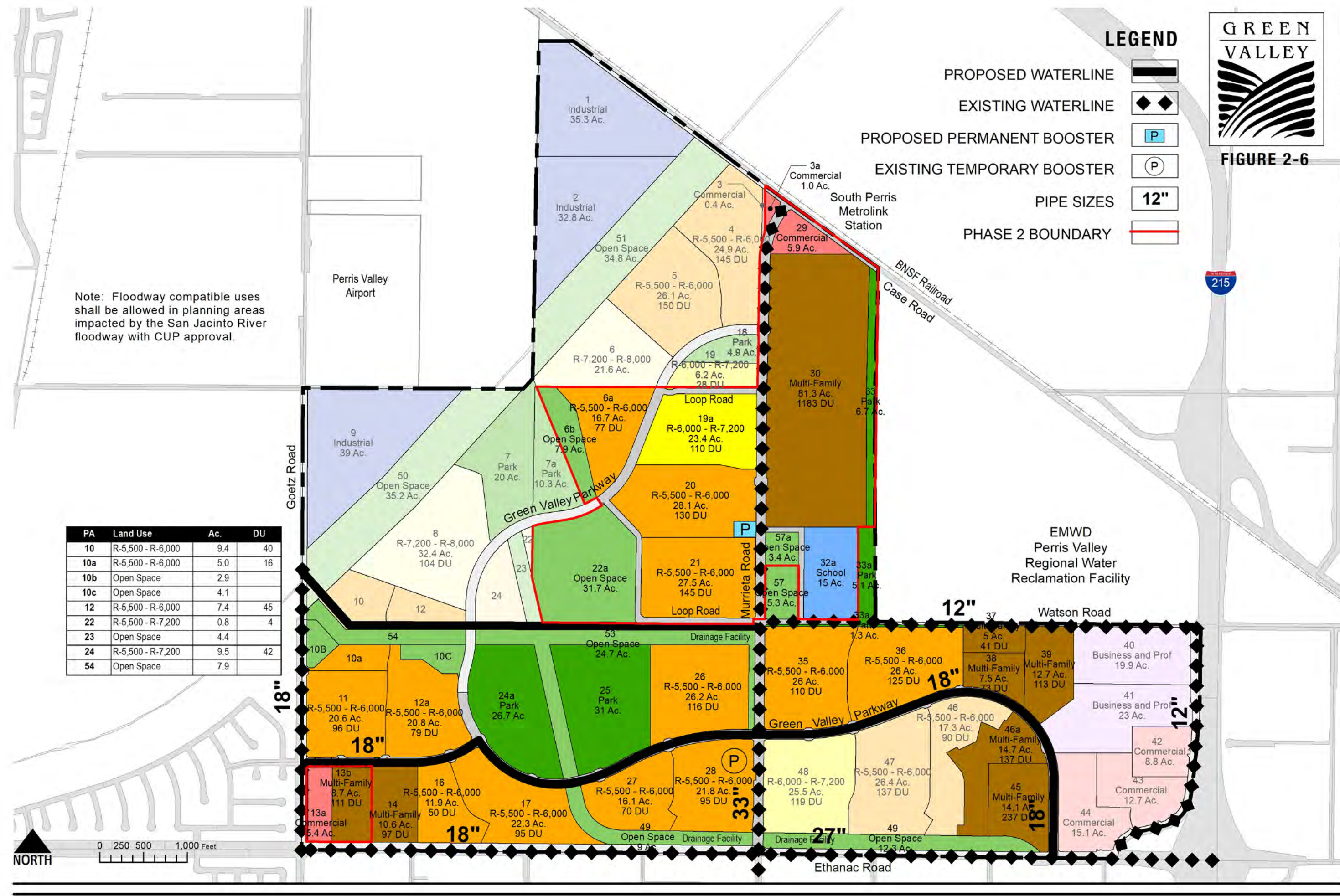






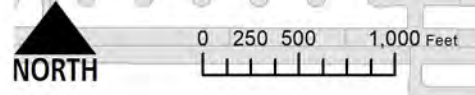
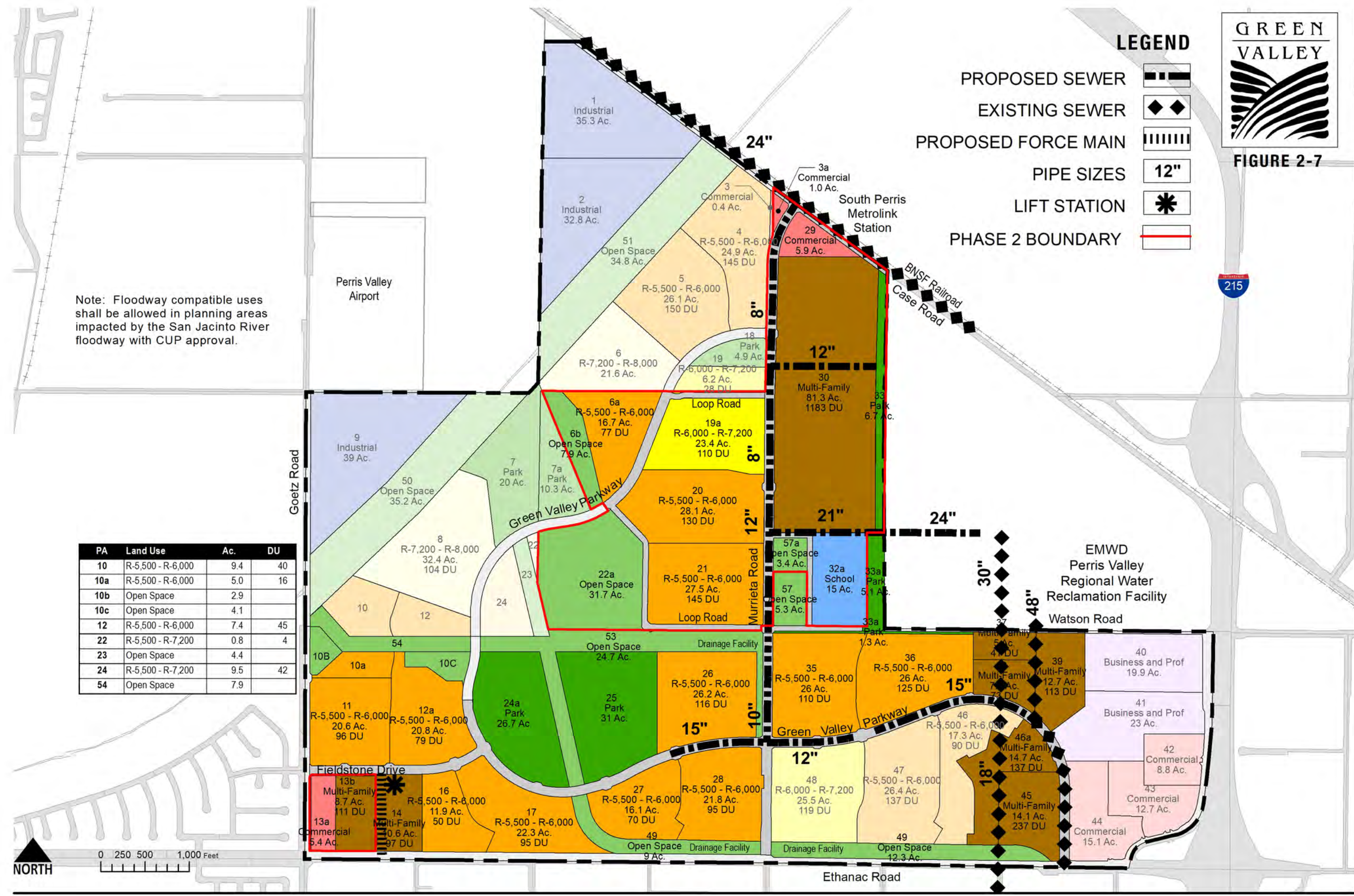
FIGURE 2-7

**LEGEND**

- PROPOSED SEWER
- EXISTING SEWER
- PROPOSED FORCE MAIN
- PIPE SIZES
- LIFT STATION
- PHASE 2 BOUNDARY

Note: Floodway compatible uses shall be allowed in planning areas impacted by the San Jacinto River floodway with CUP approval.

PA	Land Use	Ac.	DU
10	R-5,500 - R-6,000	9.4	40
10a	R-5,500 - R-6,000	5.0	16
10b	Open Space	2.9	
10c	Open Space	4.1	
12	R-5,500 - R-6,000	7.4	45
22	R-5,500 - R-7,200	0.8	4
23	Open Space	4.4	
24	R-5,500 - R-7,200	9.5	42
54	Open Space	7.9	





RECLAIMED WATER PLAN

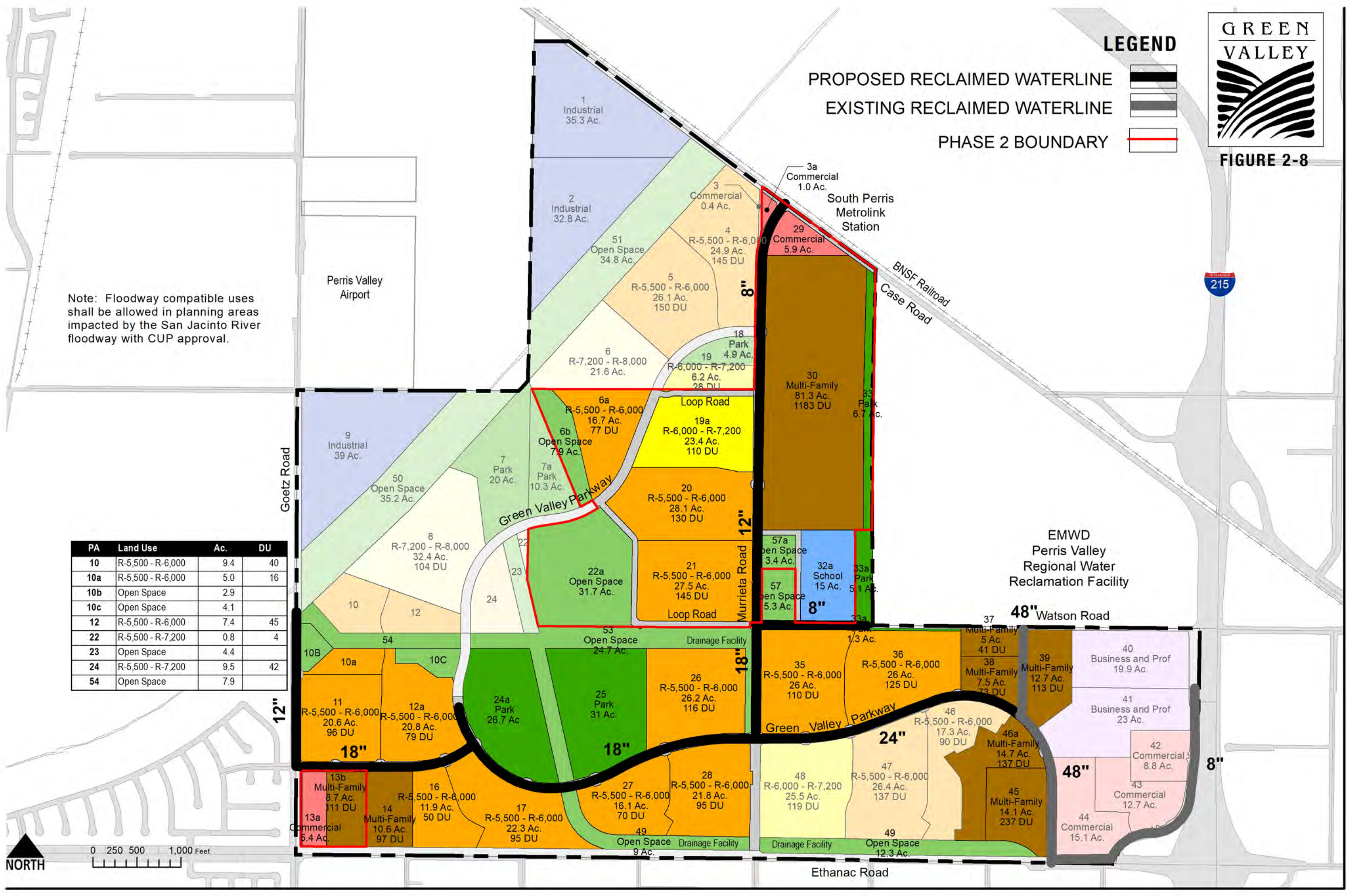


FIGURE 2-8

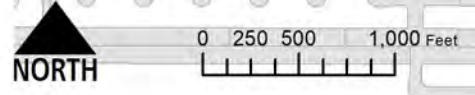
LEGEND

- PROPOSED RECLAIMED WATERLINE
- EXISTING RECLAIMED WATERLINE
- PHASE 2 BOUNDARY

Note: Floodway compatible uses shall be allowed in planning areas impacted by the San Jacinto River floodway with CUP approval.



PA	Land Use	Ac.	DU
10	R-5,500 - R-6,000	9.4	40
10a	R-5,500 - R-6,000	5.0	16
10b	Open Space	2.9	
10c	Open Space	4.1	
12	R-5,500 - R-6,000	7.4	45
22	R-5,500 - R-7,200	0.8	4
23	Open Space	4.4	
24	R-5,500 - R-7,200	9.5	42
54	Open Space	7.9	







## 2.6 CIRCULATION PLAN

### 2.6.1 Approach

The approach to design of the circulation component has been to provide for safety and efficiency through the use of public streets arranged in a hierarchy of function. The design approach also recognizes that the circulation system also serves as visual corridors and creates the basis upon which the image of the community will be largely judged. Thus, medians and enhanced parkways have been encouraged.

The Green Valley circulation plan took in consideration the importance of the existing roadway system to the regional circulation network. The site is bordered by major thoroughfares, Case Road, Ethanac Road and Goetz Road. The existing Interstate 215 interchange at Ethanac increases the importance of this road. Additionally, the site is bisected by Murrieta Road, which is a vital north-south corridor for the area. The Green Valley circulation plan incorporates these roadways in the design in order to preserve the critical transportation links they provide, while ensuring the safety and efficiency of the Green Valley community.

### 2.6.2 Plan Description

The Circulation Plan, Figure 2-9, illustrates the backbone circulation design for Green Valley. All roads within the development will be public streets and will conform to City standards while still providing aesthetic project statements. This system is designed to move traffic efficiently with little disturbance to the residential neighborhoods. Additionally, rapid ingress and egress into the various commercial, centers are provided. These goals are accomplished by restricting vehicular access onto arterial roadways to controlled points. No direct access to or between individual dwelling unit lots and arterial roadways will be permitted. Commercial and business developments will have their own internal circulation system, connected to the backbone roadways at restricted points. Final access locations to each planning area will be identified at the time of final tract submittal.

Non-vehicular circulation is an important component of the Circulation Plan. Green Valley will be linked with the regional trail system by a trail connection along Goetz Road and Case Road. Green Valley pedestrian and bicycle traffic will access this trail via local trails which will utilize the greenbelt swales and generous right-of-way along Green Valley Parkway. (See Figure 2-10.) An alternative route to the San Jacinto River Trail is provided through Phase 2 of the project in order to have a regional trail connection completed prior to the ultimate San Jacinto River improvements and MSHCP Criteria Cells mitigation, which are located outside of Green Valley Recovery Acquisition LLC landholdings. (See Figure 2-10a)

### 2.6.3 Development Standards

The proposed circulation plan will provide efficient traffic design that meets the needs of the project and is consistent with the demands of regional transportation. Through-traffic within residential neighborhoods is discouraged. Controlled access onto arterial roadways is to be restricted to specific and limited points. Vehicle access to land use areas shall be limited and subject to appropriate restrictions to be determined at the time of tentative tract map approval. Such access points will be determined in conjunction with the review of future final tract maps.



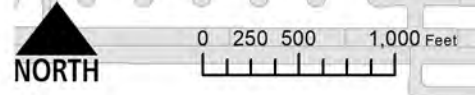
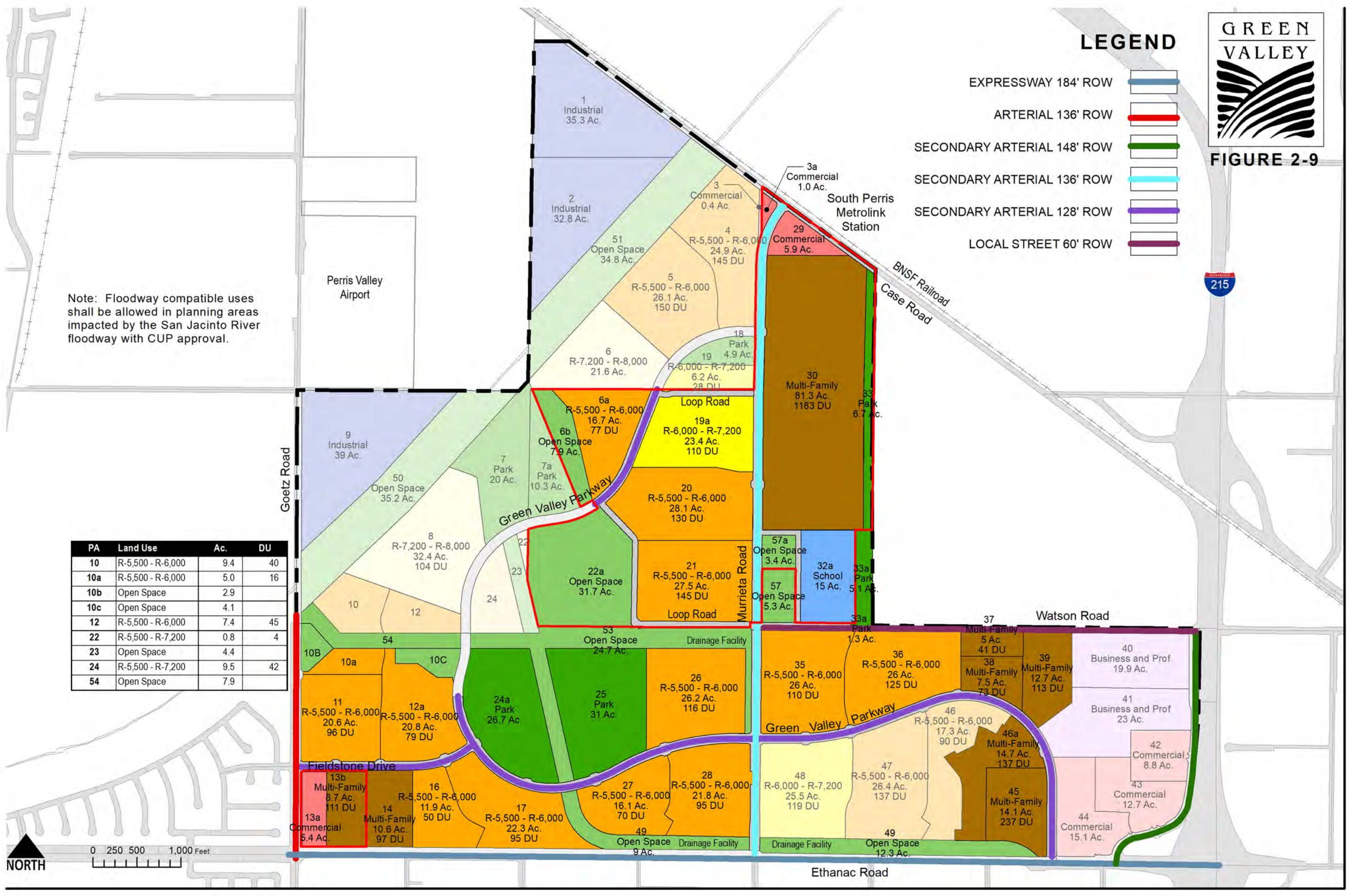
FIGURE 2-9

LEGEND

- EXPRESSWAY 184' ROW
- ARTERIAL 136' ROW
- SECONDARY ARTERIAL 148' ROW
- SECONDARY ARTERIAL 136' ROW
- SECONDARY ARTERIAL 128' ROW
- LOCAL STREET 60' ROW

Note: Floodway compatible uses shall be allowed in planning areas impacted by the San Jacinto River floodway with CUP approval.

PA	Land Use	Ac.	DU
10	R-5,500 - R-6,000	9.4	40
10a	R-5,500 - R-6,000	5.0	16
10b	Open Space	2.9	
10c	Open Space	4.1	
12	R-5,500 - R-6,000	7.4	45
22	R-5,500 - R-7,200	0.8	4
23	Open Space	4.4	
24	R-5,500 - R-7,200	9.5	42
54	Open Space	7.9	





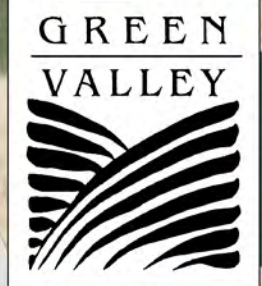
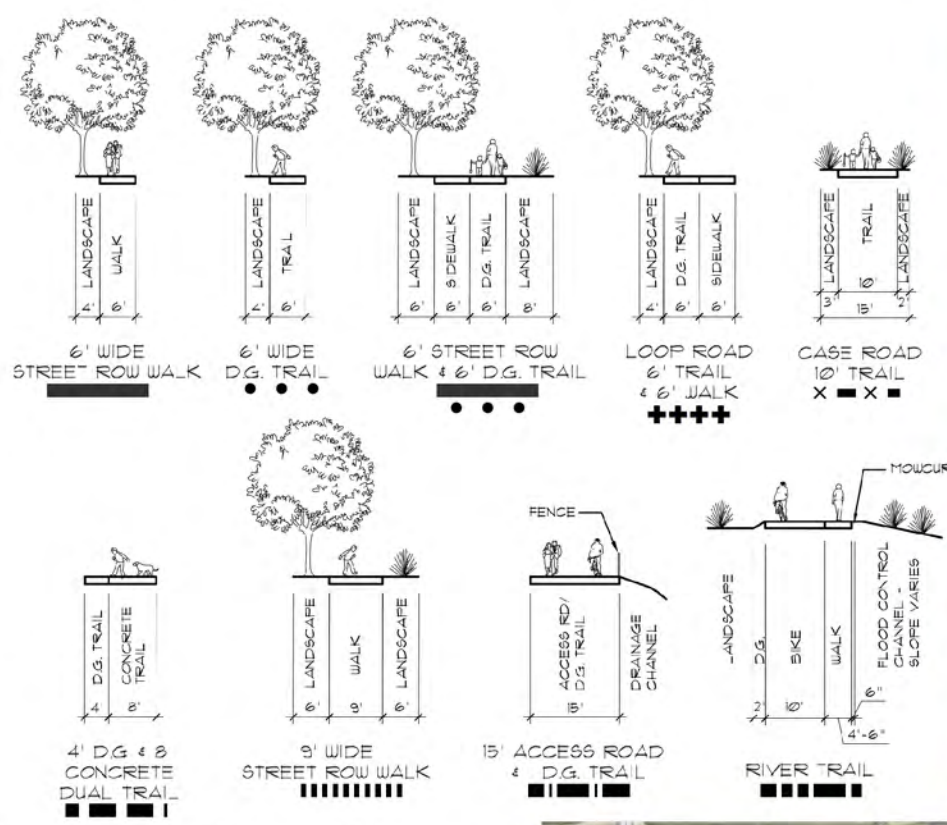
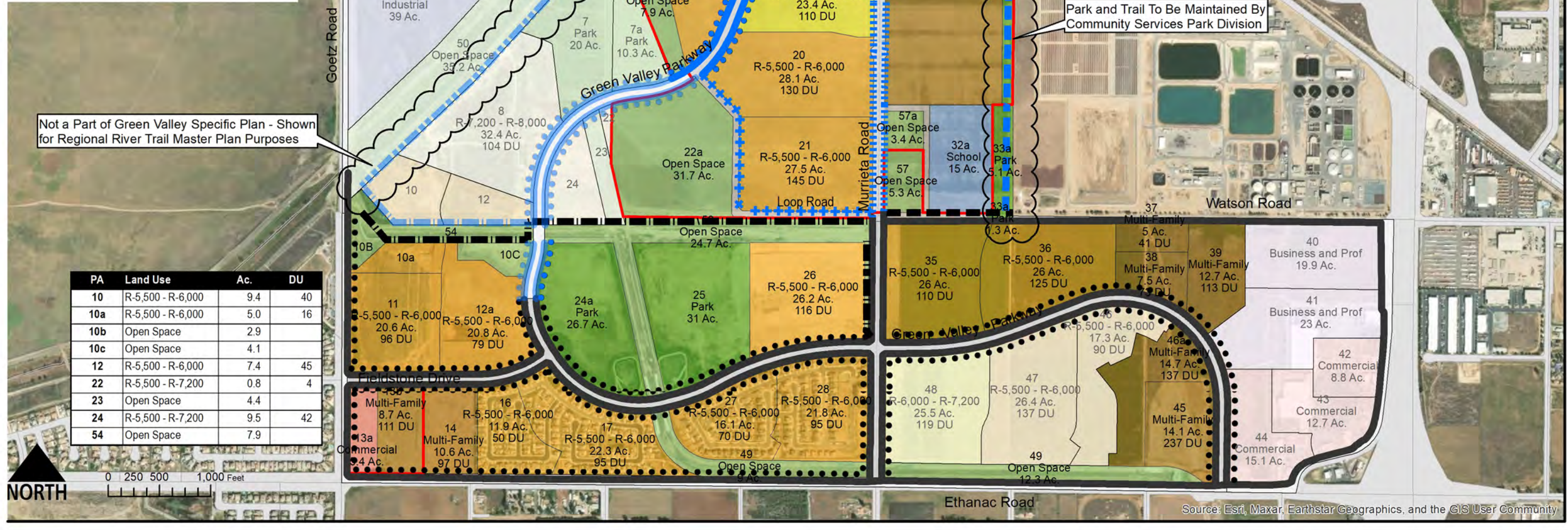


FIGURE 2-10

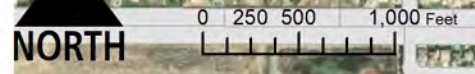


These Pedestrian Circulation Cross Sections satisfy the Implementation Guidelines requirements of Appendix 5.



Not a Part of Green Valley Specific Plan - Shown for Regional River Trail Master Plan Purposes

PA	Land Use	Ac.	DU
10	R-5,500 - R-6,000	9.4	40
10a	R-5,500 - R-6,000	5.0	16
10b	Open Space	2.9	
10c	Open Space	4.1	
12	R-5,500 - R-6,000	7.4	45
22	R-5,500 - R-7,200	0.8	4
23	Open Space	4.4	
24	R-5,500 - R-7,200	9.5	42
54	Open Space	7.9	



Source: Esri, Maxar, Earthstar Geographics, and the GIS User Community



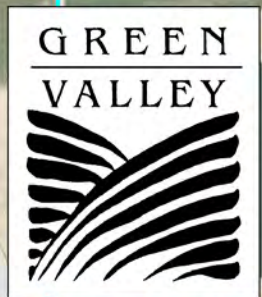
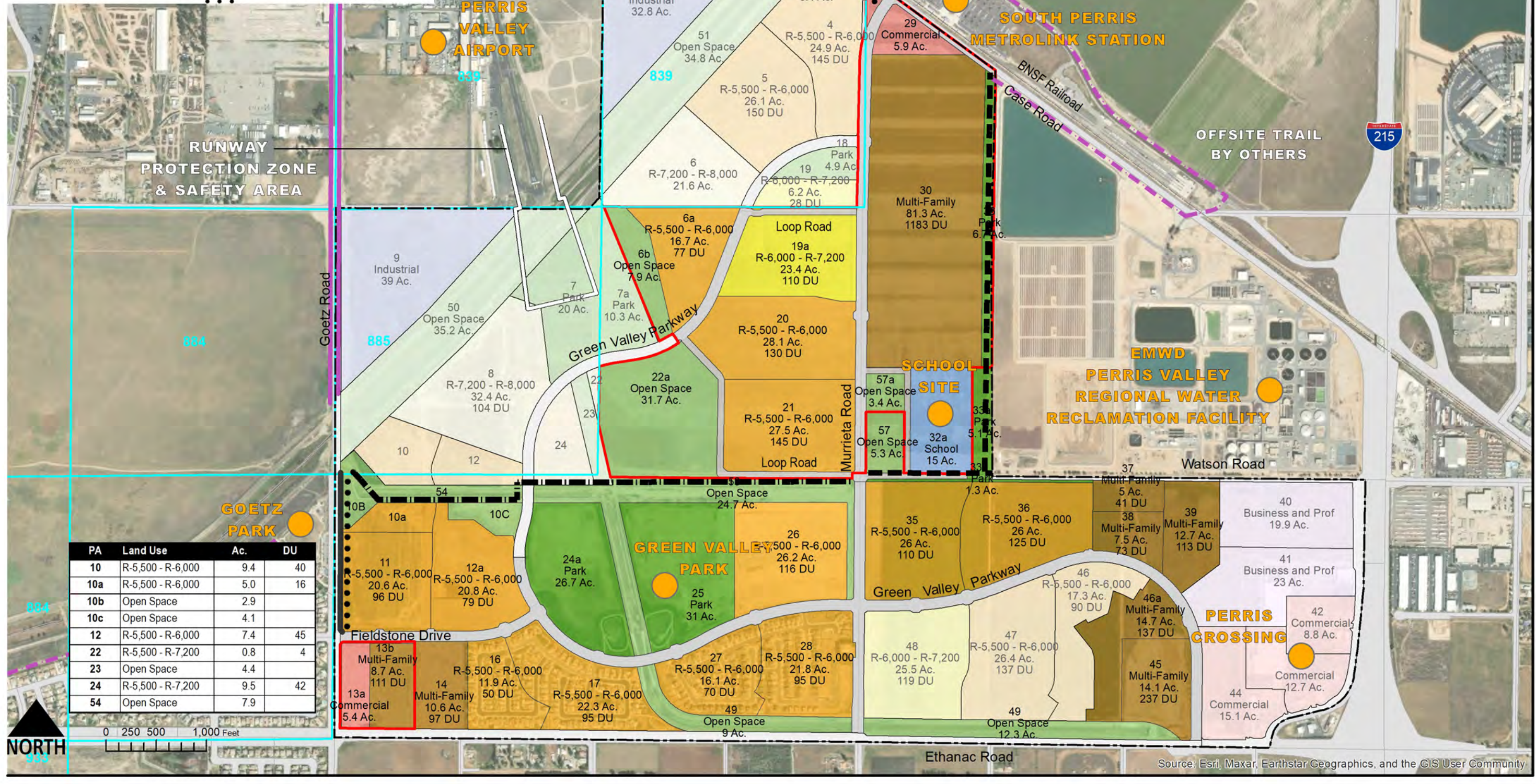
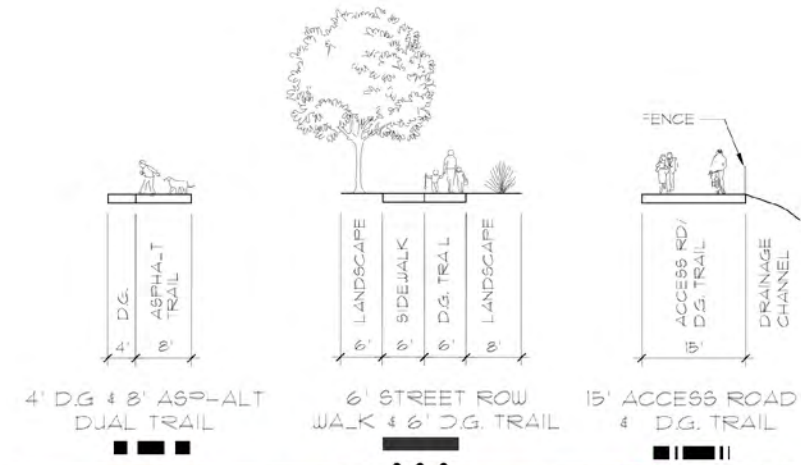
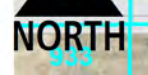


FIGURE 2-10A

- Legend**
- POINT OF INTEREST
  - 6' WIDE STREET ROW WALK
  - 6' TRAIL
  - 4' D.G. & 8' ASPHALT DUAL TRAIL
  - 15' ACCESS ROAD/D.G. TRAIL
  - OFFSITE TRAIL BY OTHERS
  - EXISTING BIKE LANE ALONG GOETZ ROAD



PA	Land Use	Ac.	DU
10	R-5,500 - R-6,000	9.4	40
10a	R-5,500 - R-6,000	5.0	16
10b	Open Space	2.9	
10c	Open Space	4.1	
12	R-5,500 - R-6,000	7.4	45
22	R-5,500 - R-7,200	0.8	4
23	Open Space	4.4	
24	R-5,500 - R-7,200	9.5	42
54	Open Space	7.9	



0 250 500 1,000 Feet

Source: Esri, Maxar, Earthstar Geographics, and the GIS User Community

SAN JACINTO RIVER TRAIL ALTERNATIVE





Major roadway improvements will be financed through an assessment district or similar financing mechanisms. All roads will be constructed to City of Perris standards, and will comply with the conditions and requirements set forth by the City Engineer. Upon completion of construction, the roadway rights-of-way will be dedicated to the City of Perris and maintained by the City Public Works Department.

The proposed circulation plan shall provide for a bicycle and pedestrian circulation system that encourages non-vehicular movement and which connects with the County of Riverside regional trail system.

The backbone road system will consist of the following major roadways:

Green Valley Parkway	128' R.O.W.	Secondary Arterial
Fieldstone Drive	128' R.O.W.	Secondary Arterial
Murrieta Road	136' R.O.W.	Secondary Arterial
Case Road	148' R.O.W.	Secondary Arterial
Ethanac Road	184' R.O.W.	Expressway
Goetz Road	136' R.O.W.	Arterial
Watson Road	60' R.O.W.	Local
Loop Road	66' R.O.W.	Local

Roadway cross-sections are shown on Figure 2-11, Street Cross Sections.

The design of the 100-foot-wide internal collectors will allow for two travel lanes and one bicycle lane in each direction. A 12-foot wide median will allow for left-hand turn lanes and center landscaping. Additionally, there will be 12 feet of sidewalks and landscaping on both sides of the roadway. The full rights-of-way of Green Valley Parkway and Murrieta Road will be developed. Case, Ethanac and Goetz Roads will be fully developed at from centerline toward the site as determined by the City Engineer. The north ends of Goetz and Case will be improved to provide a transition to the existing roads. The intersection of Murrieta and Case will be designed to reflect a 90-degree configuration.

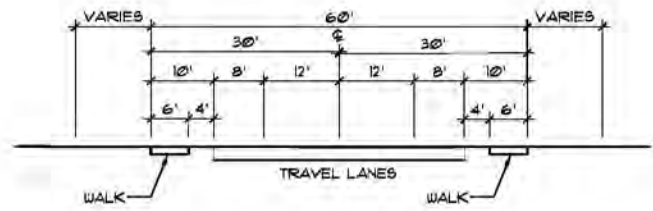
Watson Road is a two-lane roadway and full street improvements will be made where both sides of Watson Road are within the Specific Plan Area and half-street improvements will be made by Green Valley Recovery Acquisition LLC from Murrieta Road east to Planning Area 39. The owner/developer of Business and Professional Planning Area 40 will be responsible for the additional half-street improvements of Watson Road to Case Road, which was included as a part of the Engineering conditions of approval of the Perris Crossings Shopping Center. Eastern Municipal Water District is responsible for the north side half-street improvements of Watson Road adjacent to the Perris Valley Regional Water Reclamation Facility.

A Loop Road is proposed for Phase 2 west of Murrieta to provide additional vehicular and pedestrian access to Planning Areas 6a, 19a, 20, and 21. The Loop Road will connect to a portion of Green Valley Parkway that will be improved.

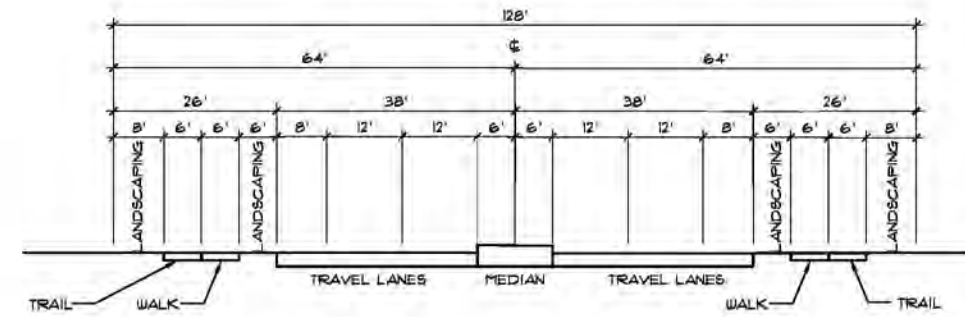


FIGURE 2-11

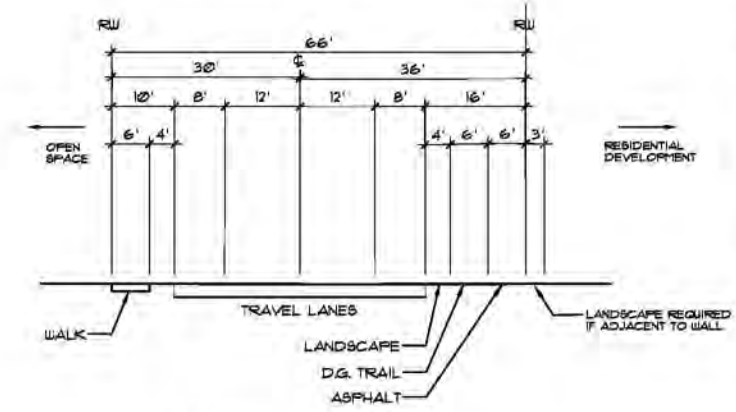
STREET CROSS SECTIONS



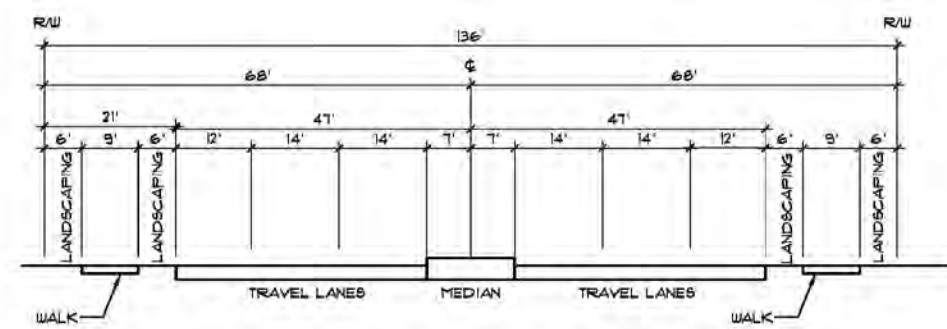
**Local Street (60')**  
Watson Road



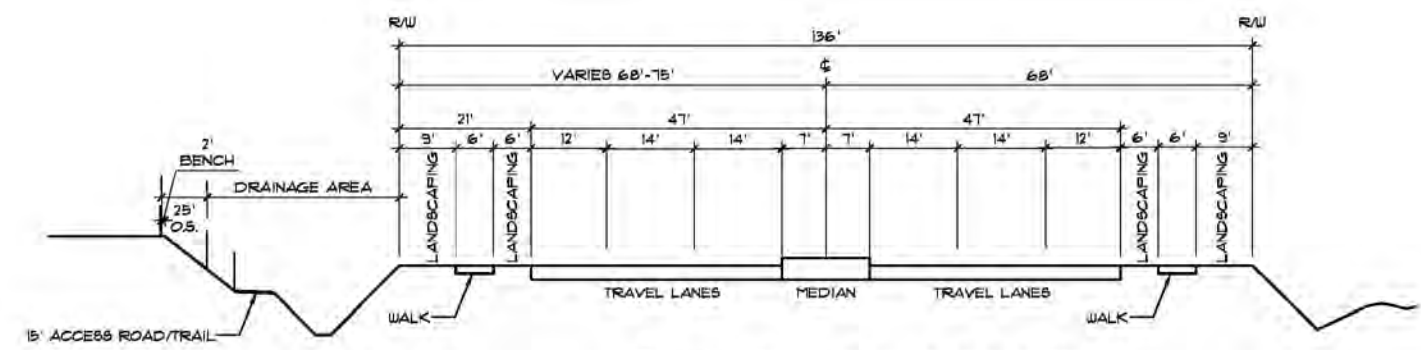
**Secondary Arterial (128')**  
Fieldstone Drive, Green Valley Parkway



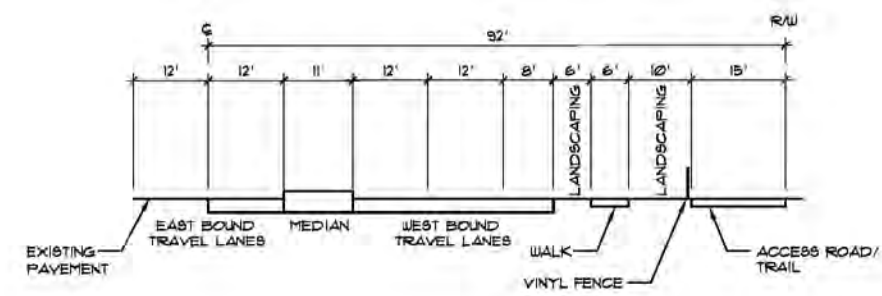
**Loop Road (66')**



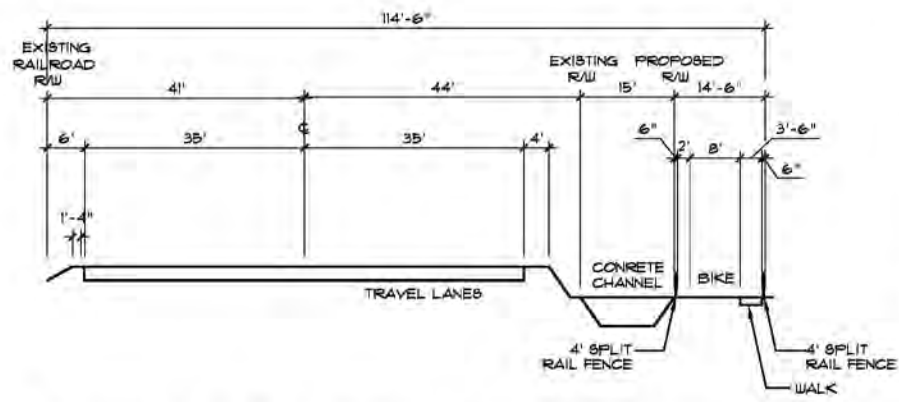
**Secondary Arterial (136')**  
Murrieta Road



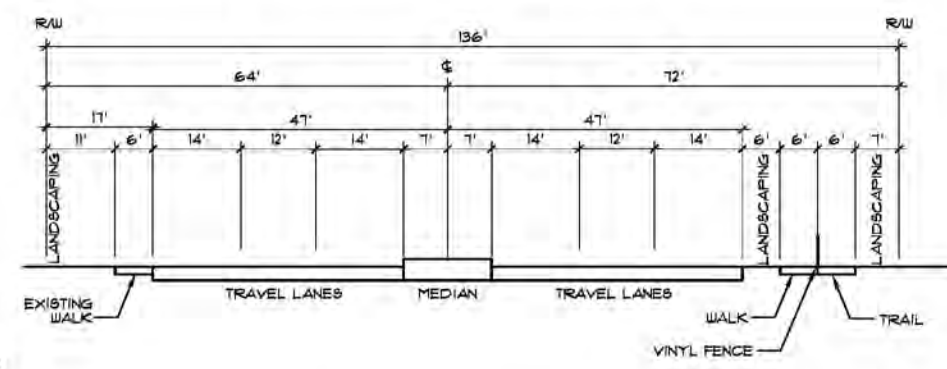
**Secondary Arterial (136')**  
Adjacent to Drainage Channel  
Murrieta Road



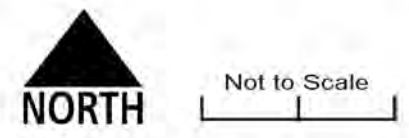
**Expressway (184' Full Width)**  
Ethanac Road



**Secondary Arterial (114.5' Full Width)**  
Case Road



**Arterial (136')**  
Goetz Road





3  
S  
P  
E  
C  
I  
F  
I  
C  
P  
L  
A  
N  
Z  
O  
N  
I  
N  
G



### 3 SPECIFIC PLAN ZONING

#### Planning Area 8

(Figure 3-1)

#### 3.1 R-7,200 – R-8,000 RESIDENTIAL STANDARDS

These Planning Areas are within the Western Riverside County Multiple Species Habitat Conservation Plan (MSHCP) Criteria Cell and are not yet approved nor entitled for the land uses identified from the original Green Valley Specific Plan. These Planning Areas requires a consistency determination with the MSHCP as part of the entitlements process.

##### 3.1.1 Permitted Uses: The uses permitted in the R-7,200 – R-8,000 Residential Zone shall be as follows (Uses are defined per Section 3.10 and P.M.C. 19.08 (Definitions)):

1. One (1) family residential dwelling of a permanent character placed in a permanent location.
2. The following accessory buildings and uses customarily incidental to each one (1) family dwelling and not used or operated commercially shall be permitted in the rear yard area, including:
  - a. A private garage for the accommodation of not less than two automobiles;
  - b. Arbors, trellises, gazebos, and similar shade structures of open construction;
  - c. Patio covers;
  - d. Swimming pools and spas;
  - e. Pedestrian and bicycle trails;
  - f. Tennis and racquet courts;
  - g. Other accessory buildings per P.M.C. 19.29 (Accessory Buildings).
3. Accessory Dwelling Units in conformance with the provisions of P.M.C. 19.81 (Accessory Dwelling Units (ADUs) and Junior Accessory Dwelling Units (JADUs)).
4. Childcare Facilities. All childcare facilities are subject to P.M.C. 19.83
5. Residential Care Facilities. All residential care facilities are subject to P.M.C. 19.84.
6. Home occupations. All home occupations are subject to P.M.C. 19.02.
7. The following conditional uses are permitted subject to approval of a Conditional Use Permit (CUP) application per P.M.C. 19.61 (Conditional Use Permits)
  - a. Churches and religious institutions.
  - b. Convalescent and senior home facilities.
  - c. Mobile home parks.
  - d. Public and semi-public institutions and facilities.
  - e. School and educational institutions.
  - f. Other similar uses as approved by the Director of Development Services, as provided in P.M.C. 19.54 (Authority and Review Procedures).
8. The following temporary uses are permitted subject to approval of a Temporary Use Permit (TUP) application:





- a. Temporary construction facility during construction;
  - b. Temporary real estate offices and model homes located within a subdivision, to be used only for and during the original sale of the subdivision;
  - c. Other uses not mentioned shall be subject to P.M.C. 19.60 (Temporary Uses).
9. The following uses are prohibited
- a. Commercial Uses.
  - b. Industrial Uses.
  - c. Large Animals
  - d. Monopoles or similar wireless communications towers or facilities.
  - e. Storage Structures greater than 120 square feet in size.

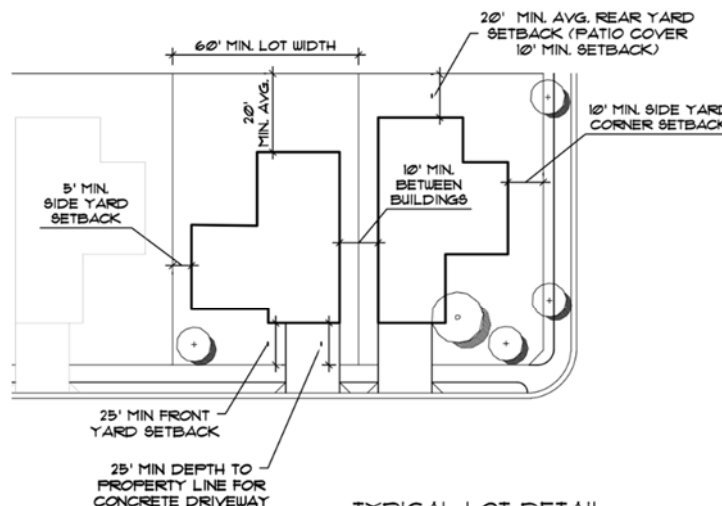
**3.1.2 Development Standards**

**Building Height Limit:** Building height limitations in the R-7,200 – R-8,000 Residential Zone shall be thirty-five (35) feet or two (2) stories.

**Minimum Lot Size:** The minimum lot size in the R-7,200 – R-8,000 Residential Zone shall be seven thousand (7,000) square feet for each single-family dwelling.

**Width of Lot:** The minimum width of that portion lot used as a building site in the R-7,200 – R-8,000 Residential Zone shall be sixty (60) feet.

**Street Frontage Required:** The minimum frontage of a lot shall be sixty (60) feet. On cul-de-sacs and knuckles the minimum frontage at the right-of-way, shall be thirty-five (35) feet.



**TYPICAL LOT DETAIL**  
(7,000 SF MIN.,  
40% MAX. BUILDING COVERAGE)  
N.T.S.



**Dwelling Area Required:** The minimum living floor area requirement in the R-7,200 – R-8,000 Residential Zone shall be one thousand two hundred and fifty (1,250) square feet, including walls and excluding the garage and accessory uses.

**Front Yard Required:** The front yard requirement in the R-7,200 – R-8,000 Residential Zone shall be not less than twenty-five (25) feet in depth. Concrete driveways are also a minimum of twenty-five (25) feet in depth.

**Side Yard Required:** The side yard requirement in the R-7,200 – R-8,000 Residential Zone shall be not less than five (5) feet from the nearest property line on interior and through lots; for side yards on corner and reverse corner lots side yards shall not be less than ten (10) feet, excluding architectural projections of two (2) feet maximum, from the existing street right-of-way line or any future street line as shown per any approved tract map.

**Rear Yard Required:** The rear yard requirement in the R-7,200 – R-8,000 Residential Zone shall be not less than twenty (20) feet average. Patio covers may extend to within ten (10) feet of the rear property line.

**Distance Between Buildings:** The minimum distance between buildings on two adjoining lots with a common side lot line in the R-7,200 – R-8,000 Residential Zone shall be no less than ten (10) feet, excluding architectural projections such as fireplace boxes and bay windows.

**Lot Coverage:** Maximum lot coverage in the R-7,200 – R-8,000 Residential Zone shall be forty percent (40%), including accessory structures.

**Setback Encroachments:** Encroachments into required setbacks in the R-7,200 – R-8,000 Residential Zone, including but not limited to architectural projections and first floor porches are subject to P.M.C. 19.02.060.

**Fences, Walls or Screening:** Fencing, walls or screening requirements in the R-7,200 – R-8,000 Residential Zone shall be as follows:

1. Fences, walls or screening may be erected, constructed or positioned upon any lot parcel of land. Fences shall not exceed six (6) feet in height, measured from the highest adjacent elevation along the side and rear lot line, nor three (3) feet in height along the front yard lot line and that portion of the side yard lot line from the front lot line to the front setback distance;
2. Walls shall not exceed six (6) feet in height measured from the highest adjacent elevation along the side and rear yard lot lines nor three (3) feet in height along front yard lot lines and that portion of the side yard line from the front lot line to the front setback distance;
3. In no case shall fences, walls or screening employed provide less than fifty percent (50%) open visibility along the side and front yard lines for a distance of fifty (50) feet on any corner lot or parcel of land closest to a public street or thoroughfare;
4. Nothing contained herein shall preclude the owner of single-family residential property from constructing internal fences which meet height and other requirements.
5. All fencing/walls facing a public right of way, easement, trail, private alley way, or internal streets shall provide a decorative block wall with a wrought iron or vinyl gate.
6. All other wall and fencing requirements not mentioned are subject to P.M.C. 19.02 (General Provisions).



**Advertising Structures:** The advertising structures permitted in the R-7,200 – R-8,000 Residential Zone shall be as follows:

1. One (1) temporary unlighted sign, not exceeding four (4) square feet in area, pertaining only to the sale, or lease of only the particular building, property or premises upon which displayed;
2. Name plates not exceeding two (2) square feet in area, containing the name and occupation of occupant of premises;
3. One (1) subdivision sign not exceeding one hundred (100) square feet in area, displayed upon the subdivision property;
4. One (1) temporary contractor sign not exceeding thirty-two (32) square feet in area, displayed upon the property on which construction is being performed;
5. One (1) temporary realty sign not to exceed four (4) square feet.
6. All other advertising temporary signage are subject to P.M.C. 19.75, specifically P.M.C. 19.75.140.

**Parking Requirements:** The parking requirements in the R-7,200 – R-8,000 Residential Zone shall be as follows:

1. A minimum of two (2) parking spaces for each dwelling unit, in an enclosed garage; and
2. Vehicles parked at other locations of the lot shall be screened from adjacent property views without disruption to the view from those properties.
3. All other parking regulations are subject to P.M.C. 19.69.

**Architectural and Landscape Design Standards:** All new construction and additions are subject to Chapter 4, Design Guidelines and P.M.C. 19.70 (Landscaping).

**Authority and Review:** Authority and review procedures are subject to P.M.C. 19.54 (Authority and Review Procedures). Please note that the Planning Commission is the approval authority for Tentative Parcel Map (TPMs) and Tentative Tract Maps (TTMs) unless processed concurrently with an SPA.

**LEGEND**

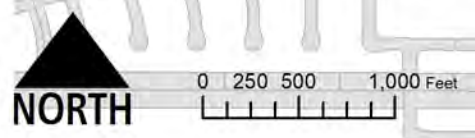
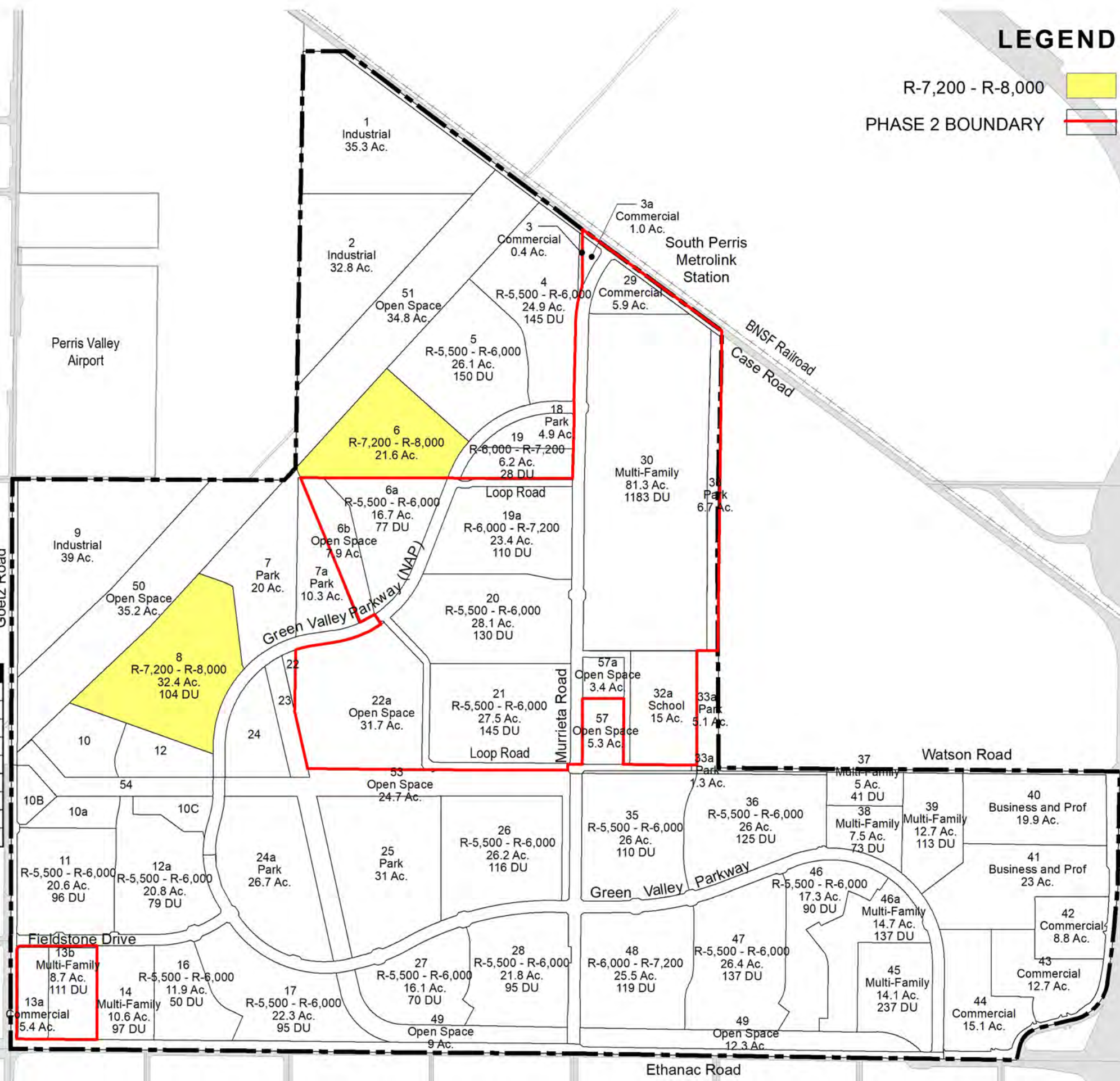
R-7,200 - R-8,000   
 PHASE 2 BOUNDARY



**FIGURE 3-1**

Note: Floodway compatible uses shall be allowed in planning areas impacted by the San Jacinto River floodway with CUP approval.

PA	Land Use	Ac.	DU
10	R-5,500 - R-6,000	9.4	40
10a	R-5,500 - R-6,000	5.0	16
10b	Open Space	2.9	
10c	Open Space	4.1	
12	R-5,500 - R-6,000	7.4	45
22	R-5,500 - R-7,200	0.8	4
23	Open Space	4.4	
24	R-5,500 - R-7,200	9.5	42
54	Open Space	7.9	



R - 7 2 0 0 - R - 8 0 0 0 R E S I D E N T I A L



### 3.2 R-6,000 – R-7,200 RESIDENTIAL STANDARDS

Planning Areas 19, 19a, and 48  
(Figure 3-2)

#### 3.2.1 Permitted Uses: The uses permitted in the R-6,000 – R-7,200 Residential Zone shall be as follows (Uses are defined per Section 3.10 and P.M.C. 19.08 (Definitions)):

1. One (1) family residential dwelling of a permanent character placed in a permanent location.
2. The following accessory buildings and uses customarily incidental to each one family dwelling and not used or operated commercially shall be permitted, including:
  - a. A private garage for the accommodation of not less than two automobiles;
  - b. Arbors, trellises, gazebos, and similar shade structures of open construction;
  - c. Patio covers;
  - d. Swimming pools and spas;
  - e. Pedestrian and bicycle trails;
  - f. Tennis and racquet courts.
3. Accessory Dwelling Units in conformance with the provisions of P.M.C. 19.81 - Accessory Dwelling Units (ADUs) and Junior Accessory Dwelling Units (JADUs).
4. Childcare Facilities. All childcare facilities are subject to P.M.C. 19.83.
5. Residential Care Facilities. All residential care facilities are subject to P.M.C. 19.84.
6. Home occupations. All home occupations are subject to P.M.C. 19.02.
7. The following conditional uses are permitted subject to approval of a Conditional Use Permit (CUP) application per P.M.C. 19.61 (Conditional Use Permits)
  - a. Churches and religious institutions.
  - b. Convalescent and senior home facilities.
  - c. Mobile home parks.
  - d. Public and semi-public institutions and facilities.
  - e. School and educational institutions.
  - f. Other similar uses as approved by the Director of Development Services, as provided in P.M.C. 19.54 (Authority and Review Procedures).
8. The following temporary uses are permitted subject to approval of a Temporary Use Permit (TUP) application:
  - a. Temporary construction facility during construction;
  - b. Temporary real estate offices and model homes located within a subdivision, to be used only for and during the original sale of the subdivision;
  - c. Other uses not mentioned shall be subject to P.M.C. 19.60 (Temporary Uses).

9. The following uses are prohibited
  - a. Commercial Uses.
  - b. Industrial Uses.
  - c. Large Animals
  - d. Monopoles or similar wireless communications towers or facilities.
  - e. Storage Structures greater than 120 square feet in size.

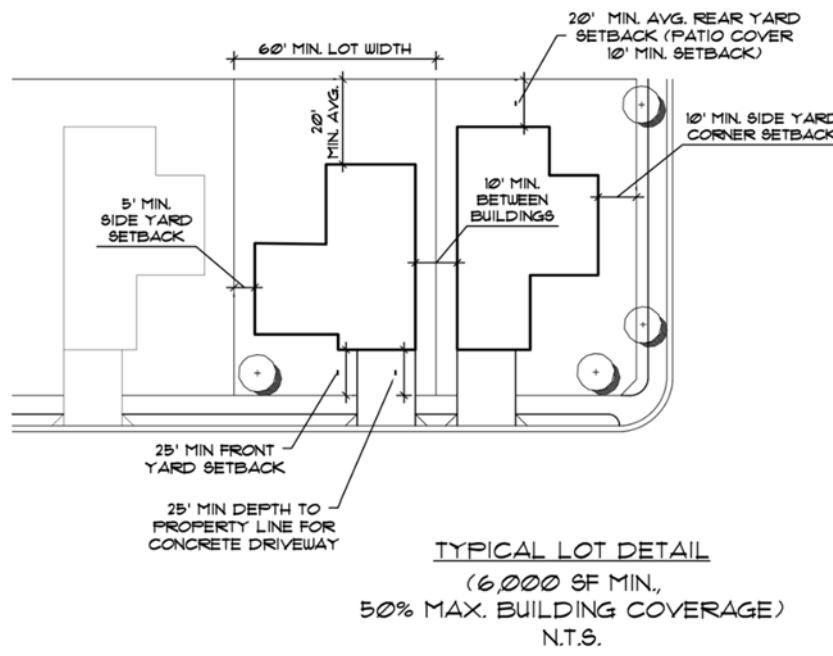
**3.2.2 Development Standards**

**Building Height Limit:** Building height limitations in the R-6,000 – R-7,200 Residential Zone shall be thirty-five (35) feet or two (2) stories.

**Minimum Lot Size:** The minimum lot size in the R-6,000 – R-7,200 Residential Zone shall be six thousand (6,000) square feet for each single family dwelling with a planning area average not less than six thousand (6,000) square feet.

**Width of Lot:** The minimum width of that portion lot used as a building site in the R-6,000 – R-7,200 Residential Zone shall be sixty (60) feet.

**Dwelling Area Required:** The minimum living floor area requirement in the R-6,000 – R-7,200 Residential Zone shall be one thousand two hundred (1,200) square feet, including walls and excluding the garage and accessory uses. Architecture and general appearance shall be in keeping with the character of the neighborhood and such as not to be detrimental to the general welfare of the community in which it is located.







**Street Frontage Required:** The minimum frontage of a lot shall be sixty (60) feet. On cul-de-sacs or knuckles, the minimum front shall be thirty-five (35) feet at the right-of-way line.

**Front Yard Required:** The front yard requirement in the R-6,000 – R-7,200 Residential Zone shall be not less than twenty-five (25) feet in depth. Concrete driveways are also a minimum of twenty-five (25) feet in depth.

**Side Yard Required:** The side yard requirement in the R-6,000 – R-7,200 Residential Zone shall be not less than five (5) feet from the nearest property line on interior and through lots; for side yards on corner and reverse corner lots side yards shall not be less than ten (10) feet, excluding architectural projections of two (2) feet maximum, from the existing street right-of-way line or any future street line as shown per any approved tract map.

**Rear Yard Required:** The rear yard requirement in the R-6,000 – R-7,200 Residential Zone shall be not less than twenty (20) feet average. Patio covers may extend to within ten (10) feet of the rear property line.

**Distance Between Buildings:** The minimum distance between buildings on two adjoining lots with a common side lot line in R-6,000 – R-7,200 Residential Zone shall be no less than ten (10) feet, excluding architectural projections such as fireplace boxes and bay windows.

**Lot Coverage:** Maximum lot coverage in the R-6,000 – R-7,200 Residential Zone shall be fifty percent (50%), including accessory structures.

**Setback Encroachments:** Encroachments into required setbacks in the R-6,000 – R-7,200 Residential Zone, including but not limited to architectural projections and first floor porches are subject to P.M.C. 19.02.060.

**Fences, Walls or Screening:** Fencing, walls or screening requirements in the R-6,000 – R-7,200 Residential Zone shall be as follows:

1. Fences, walls or screening may be erected, constructed or positioned upon any lot parcel of land. Fences shall not exceed six (6) feet in height, measured from the highest adjacent elevation along the side and rear lot line, nor three (3) feet in height along the front yard lot line and that portion of the side yard lot line from the front lot line to the front setback distance;
2. Walls shall not exceed six (6) feet in height measured from the highest adjacent elevation along the side and rear yard lot lines nor three (3) feet in height along front yard lot lines and that portion of the side yard line from the front lot line to the front setback distance;
3. In no case shall fences, walls or screening employed provide less than fifty percent (50%) open visibility along the side and front yard lines for a distance of fifty (50) feet on any corner lot or parcel of land closest to a public street or thoroughfare;
4. Nothing contained herein shall preclude the owner of single-family residential property from constructing internal fences which meet height and other requirements.
5. All fencing/walls facing a public right of way, easement, trail, private alley way, or internal streets shall provide a decorative block wall with a wrought iron or vinyl gate.
6. All other wall and fencing requirements not mentioned are subject to P.M.C. 19.02 (General Provisions).



**Advertising Structures:** The advertising structures permitted in the R-6,000 – R-7,200 Residential Zone shall be as follows:

1. One (1) temporary unlighted sign, not exceeding four (4) square feet in area, pertaining only to the sale, or lease of only the particular building, property or premises upon which displayed;
2. Name plates not exceeding two (2) square feet in area, containing the name and occupation of occupant of premises;
3. One (1) subdivision sign not exceeding one hundred (100) square feet in area, displayed upon the subdivision property;
4. One (1) temporary contractor sign not exceeding thirty-two (32) square feet in area, displayed upon the property on which construction is being performed;
5. One (1) temporary realty sign not to exceed four (4) square feet.
6. All other advertising temporary signage are subject to P.M.C. 19.75, specifically P.M.C. 19.75.140.

**Parking Requirements:** The parking requirements in the R-6,000 – R-7,200 Residential Zone shall be as follows:

1. A minimum of two (2) parking spaces for each dwelling unit, in an enclosed garage; and
2. Vehicles parked at other locations on the lot shall be screened from adjacent properties without disrupting views from those properties.

All other parking regulations are subject to P.M.C. 19.69.

**Architectural and Landscape Design Standards:** All new construction and additions are subject to Chapter 4, Design Guidelines and P.M.C. 19.70 (Landscaping).

**Authority and Review:** Authority and review procedures are subject to P.M.C. 19.54 (Authority and Review Procedures). Please note that the Planning Commission is the approval authority for Tentative Parcel Map (TPMs) and Tentative Tract Maps (TTMs) unless processed concurrently with an SPA.





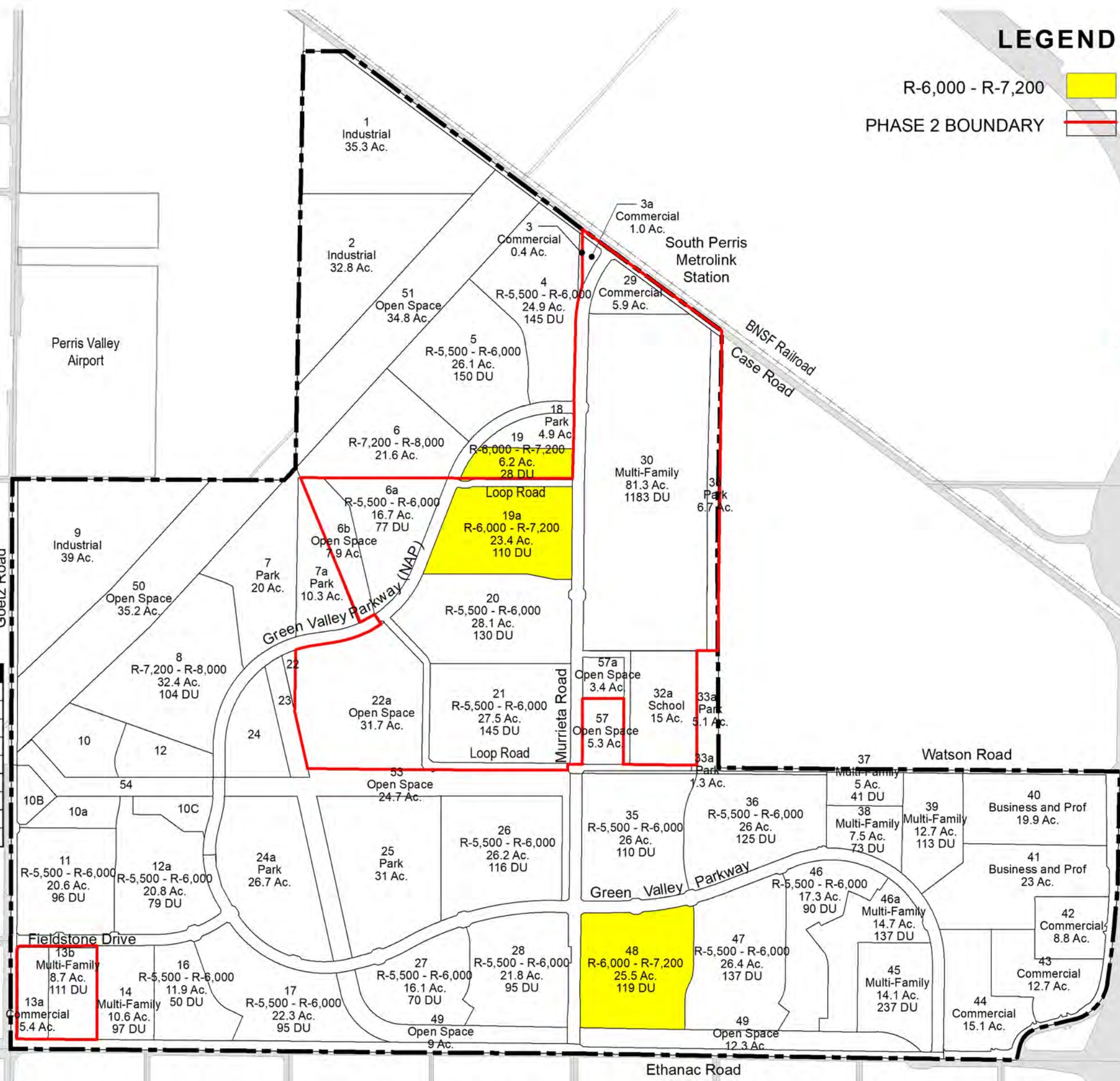
FIGURE 3-2

**LEGEND**

- R-6,000 - R-7,200
- PHASE 2 BOUNDARY

Note: Floodway compatible uses shall be allowed in planning areas impacted by the San Jacinto River floodway with CUP approval.

PA	Land Use	Ac.	DU
10	R-5,500 - R-6,000	9.4	40
10a	R-5,500 - R-6,000	5.0	16
10b	Open Space	2.9	
10c	Open Space	4.1	
12	R-5,500 - R-6,000	7.4	45
22	R-5,500 - R-7,200	0.8	4
23	Open Space	4.4	
24	R-5,500 - R-7,200	9.5	42
54	Open Space	7.9	



R - 6 0 0 0 - R - 7 2 0 0 R E S I D E N T I A L



**3.3 R-5,500 – R-6,000 RESIDENTIAL ZONE**

Planning Areas 4, 5, 6a, 10, 10a, 11, 12, 12a, 16, 17, 20, 21, 26, 27, 28, 35, 36, 46, and 47.

(Figure 3-3)

**3.3.1 Permitted Uses: The uses permitted in the R-5,500 – R-6,000 Residential Zone shall be as follows (Uses are defined per Section 3.10 and P.M.C. 19.08 (Definitions)):**

1. One (1) family dwelling of a permanent character placed in a permanent location.
2. Accessory buildings and uses customarily incidental to each one (1) family dwelling and not used or operated commercially shall be permitted in the rear area, including:
  - a. A private garage for the accommodations of not more than three (3) nor less than two automobiles;
  - b. Arbors, trellises, gazebos, and similar shade structures of open construction;
  - c. Patio covers;
  - d. Swimming pools and spas;
  - e. Pedestrian and bicycle trails;
  - f. Tennis and racquet courts;
  - g. Other accessory buildings per P.M.C. 19.29 (Accessory Buildings).
3. Accessory Dwelling Units in conformance with the provisions of 19.81 - Accessory Dwelling Units (ADUs) and Junior Accessory Dwelling Units (JADUs)).
4. Childcare Facilities. All childcare facilities are subject to P.M.C. 19.83.
5. Residential Care Facilities. All residential care facilities are subject to P.M.C. 19.84.
6. Home occupations. All home occupations are subject to P.M.C. 19.02.
7. The following conditional uses are permitted subject to approval of a Conditional Use Permit (CUP) application per P.M.C. 19.61 (Conditional Use Permits)
  - a. Churches and religious institutions.
  - b. Convalescent and senior home facilities.
  - c. Mobile home parks.
  - d. Public and semi-public institutions and facilities.
  - e. School and educational institutions.
  - f. Other similar uses as approved by the Director of Development Services, as provided in P.M.C. 19.54 (Authority and Review Procedures).
8. The following temporary uses are permitted subject to a Temporary Use Permit (TUP) application:
  - a. Temporary construction facility during construction;
  - b. Temporary real estate offices and model homes located within a subdivision, to be used only for and during the original sale of the subdivision;
  - c. Other temporary uses not mentioned shall be subject to P.M.C. 19.60 (Temporary Uses).



- 9. The following uses are prohibited
  - a. Commercial Uses.
  - b. Industrial Uses.
  - c. Large Animals
  - d. Monopoles or similar wireless communications towers or facilities.
  - e. Storage Structures greater than 120 square feet in size.

**3.3.2 Development Standards**

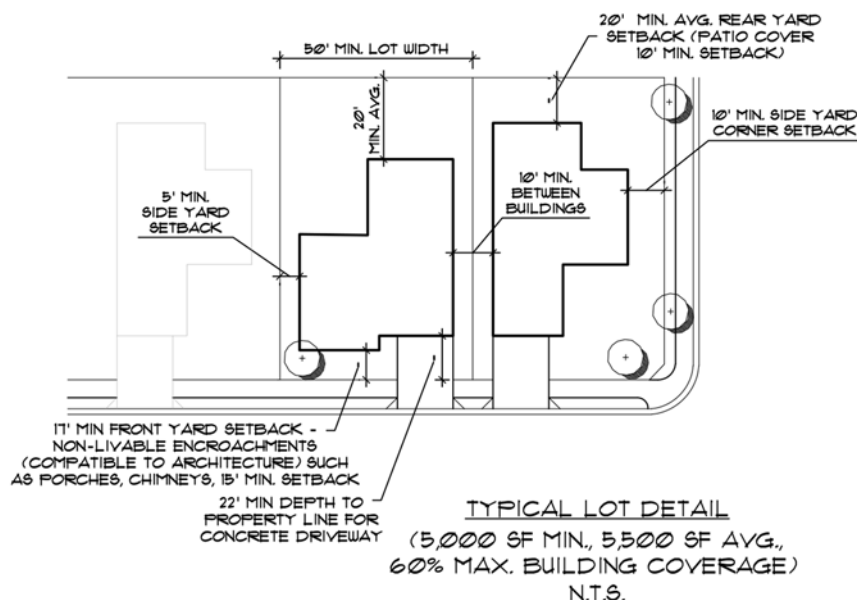
**Building Height Limit:** Building height limitations in the R-5,500 – R-6,000 Residential Zone shall be thirty-five (35) feet or two (2) stories.

**Minimum Lot Size:** The minimum lot size for the R-5,500 – R-6,000 Residential Zone shall be five thousand (5,000) square feet for each single family dwelling with a planning area average not less than five thousand five hundred (5,500) square feet.

**Width of Lot:** The minimum width of that portion lot used as a building site in the R-5,500 – R-6,000 Residential Zone shall be fifty (50) feet.

**Dwelling Area Required:** The minimum living floor area requirement in the R-5,500 – R-6,000 Residential Zone shall be one thousand two hundred (1,200) square feet, including walls and excluding the garage and accessory uses. Architecture and general appearance shall be in keeping with the character of the neighborhood and such as not to be detrimental to the general welfare of the community in which it is located.

**Street Frontage Required:** The minimum street frontage of a lot shall be fifty (50) feet. On cul-de-sacs or knuckles the minimum frontage shall be thirty-five (35) feet measured at the right-of-way.





**Front Yard Required:** The front yard requirement in the R-5,500 – R-6,000 Residential Zone shall be not less than seventeen (17) feet from the front property line. Non-livable encroachments (compatible to the architecture) such as porches, chimneys shall not be less than fifteen (15) feet from the front property line. Concrete driveways shall be a minimum of twenty-two (22) feet in depth from garage to the property line.

**Side Yard Required:** The side yard requirement in the R-5,500 – R-6,000 Residential Zone shall be not less than five (5) feet from the nearest property line on interior and through lots; for side yards on corner and reverse corner lots side yards shall not be less than ten (10) feet, excluding architectural projections of two (2) feet maximum, from the existing street right-of-way line or any future street line as shown per any approved tract map.

**Rear Yard Required:** The rear yard requirement in the R-5,500 – R-6,000 Residential Zone shall be not less than twenty (20) feet average. Patio covers may extend to within ten (10) feet of the rear property line.

**Distance Between Buildings:** The minimum distance between buildings on two adjoining lots with a common side lot line in the R-5,500 – R-6,000 Residential Zone shall be no less than ten (10) feet, excluding architectural projections such as fireplace boxes and bay windows.

**Lot Coverage:** Maximum lot coverage in the R-5,500 – R-6,000 Residential Zone shall be sixty percent (60%), including accessory structures.

**Setback Encroachments:** Encroachments into required setbacks in the R-5,500 – R-6,000 Residential Zone, including but not limited to architectural projections and first floor porches are subject to P.M.C. 19.02.060.

**Fences, Walls or Screening:** Fencing, walls or screening requirements in the R-5,500 – R-6,000 Residential Zone shall be as follows:

1. Fences, walls or screening may be erected, constructed or positioned upon any lot parcel of land. Fences shall not exceed six (6) feet in height, measured from the highest adjacent elevation along the side and rear lot line, nor three (3) feet in height along the front yard lot line and that portion of the side yard lot line from the front lot line to the front setback distance, and shall be so constructed as to ensure a minimum open visibility of fifty percent (50%) along that portion of the front yard line and that portion of the side yard line from the front yard line to the front setback distance;
2. Walls shall not exceed six (6) feet in height measured from the highest adjacent elevation along the side and rear yard lot lines nor three (3) feet in height along front yard lot lines and that portion of the side yard line from the front lot line to the front setback distance;
3. In no case shall fences, walls or screening employed provide less than fifty percent (50%) open visibility along the side and front yard lines for a distance of fifty (50) feet on any corner lot or parcel of land closest to a public street or thoroughfare;
4. Nothing contained herein shall preclude the owner of single-family residential property from constructing internal fences which meet height and other requirements.
5. All fencing/walls facing a public right of way, easement, trail, private alley way, or internal streets shall provide a decorative block wall with a wrought iron or vinyl gate.



6. All other wall and fencing requirements not mentioned are subject to P.M.C. 19.02 (General Provisions).

**Advertising Structures:** The advertising structures permitted in the R-5,500 – R-6,000 Residential Zone shall be as follows:

1. One (1) temporary unlighted sign, no exceeding four (4) square feet in area, pertaining only to the sale, or hire of only the particular building, property or premises upon which displayed;
2. Name plates not exceeding two (2) square feet in area, containing the name and occupation of occupant of premises;
3. One (1) subdivision sign not exceeding one hundred (100) square feet in area, displayed upon the subdivision property;
4. One (1) temporary contractor sign not exceeding thirty-two (32) square feet in area, displayed upon the property on which construction is being performed;
5. One (1) temporary realty sign not to exceed four (4) square feet.
6. All other advertising temporary signage are subject to P.M.C. 19.75, specifically P.M.C. 19.75.140.

**Parking Requirements:** The parking requirements in the R-5,500 – R-6,000 Residential Zone shall be as follows:

1. A minimum of two (2) parking spaces for each dwelling unit, in an enclosed garage; and
2. Vehicles parked at other locations on the lot shall be screened from adjacent properties without disrupting views from those properties.
3. All other parking regulations subject to P.M.C. 19.69 (Parking standards).

**Architectural and Landscape Design Standards:** All new construction and additions are subject to Chapter 4, Design Guidelines and P.M.C. 19.70 (Landscaping).

**Authority and Review:** Authority and review procedures are subject to P.M.C. 19.54 (Authority and Review Procedures). Please note that the Planning Commission is the approval authority for Tentative Parcel Map (TPMs) and Tentative Tract Maps (TTMs) unless processed concurrently with an SPA.



**LEGEND**

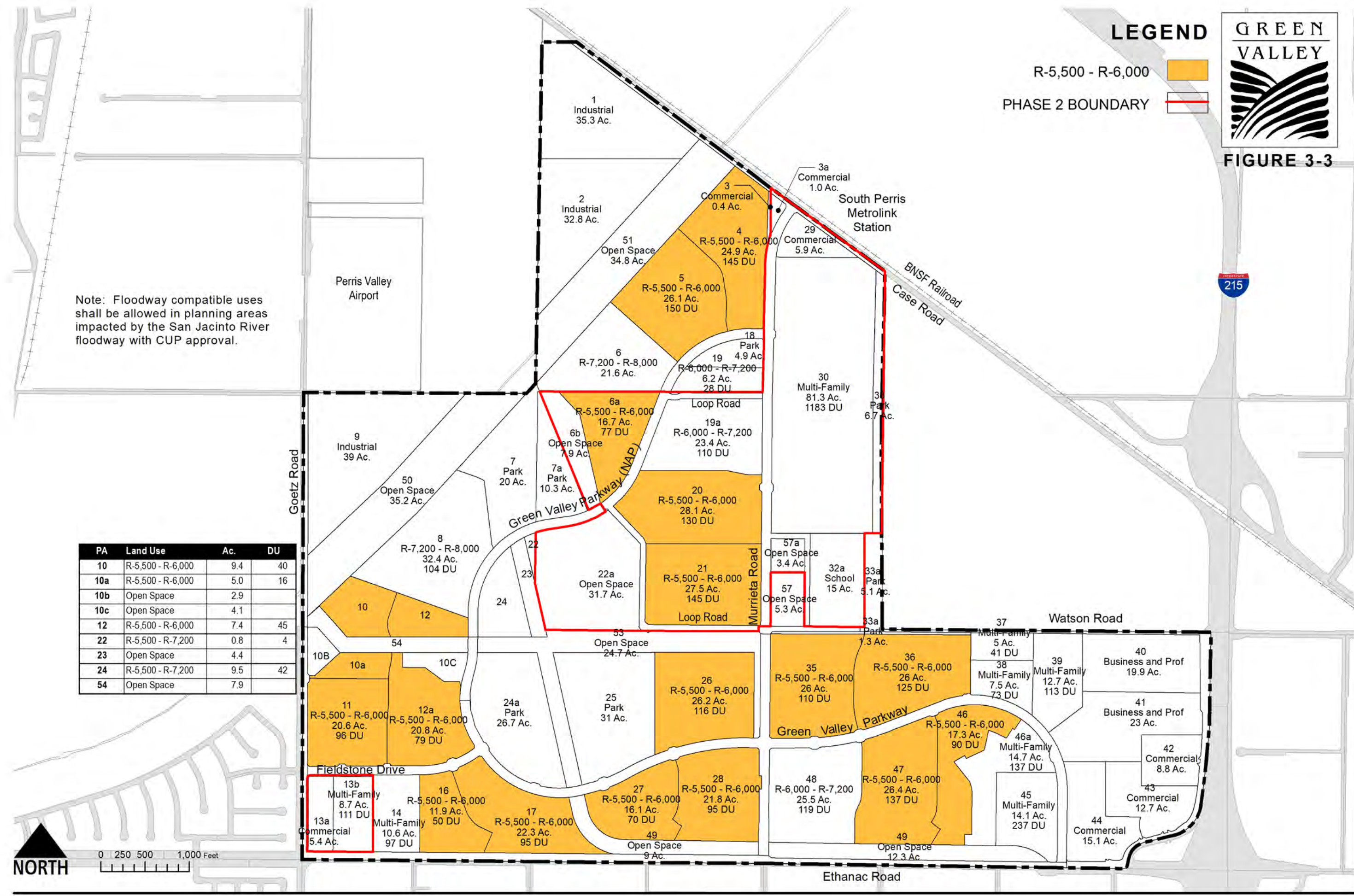
- R-5,500 - R-6,000
- PHASE 2 BOUNDARY



**FIGURE 3-3**

Note: Floodway compatible uses shall be allowed in planning areas impacted by the San Jacinto River floodway with CUP approval.

PA	Land Use	Ac.	DU
10	R-5,500 - R-6,000	9.4	40
10a	R-5,500 - R-6,000	5.0	16
10b	Open Space	2.9	
10c	Open Space	4.1	
12	R-5,500 - R-6,000	7.4	45
22	R-5,500 - R-7,200	0.8	4
23	Open Space	4.4	
24	R-5,500 - R-7,200	9.5	42
54	Open Space	7.9	



R - 5 5 0 0 - R - 6 0 0 0 R E S I D E N T I A L



### 3.4 MULTI-FAMILY RESIDENTIAL STANDARDS

Planning Areas 13b, 14, 30, 37, 38, 39, 45, and 46a.

(Figure 3-4)

#### 3.4.1 Permitted Uses: The uses permitted in the Multi-Family Residential Zone shall be as follows (Uses are defined per Section 3.10 and P.M.C. 19.08 (Definitions)):

1. Multiple dwellings, including cooperative apartment houses, condominium dwellings, townhomes, small-lot detached, and single-family court;
2. Zero lot line development, including twin homes and other homes.
3. The following accessory buildings and uses customarily incidental to multi-family residences and not used or operated commercially shall be permitted in the rear yard area subject to required setback and lot coverage requirements, including:
  - a. A private garage or carport for the accommodation of not more than three (3) automobiles per residential unit;
  - b. Arbors, trellises, gazebos, and similar shade structures of open construction;
  - c. Swimming pools and spas, tennis and racquet courts, and other recreational facilities, provided that these facilities are enclosed to prevent access by children not accompanied by an adult;
  - d. Offices, laundry room facilities, maintenance buildings, and other uses customarily incidental and subordinated with the primary uses;
  - e. Patio covers;
  - f. Pedestrian and bicycle trails; and
  - g. All other accessory buildings per P.M.C. 19.29 (Accessory Buildings).
4. Accessory Dwelling Units. Are subject to 19.81 - Accessory Dwelling Units (ADUs) and Junior Accessory Dwelling Units (JADUs)).
5. Home occupations. All home occupations are subject to P.M.C. 19.02.
6. The following conditional uses are permitted subject to approval of a Conditional Use Permit (CUP) application per P.M.C. 19.61 (Conditional Use Permits)
  - a. Churches and religious institutions.
  - b. Convalescent and senior home facilities.
  - c. Mobile home parks.
  - d. Public and semi-public institutions and facilities.
  - e. School and educational institutions.
  - f. Other similar uses as approved by the Director of Development Services, as provided in P.M.C. 19.54 (Authority and Review Procedures).
7. The following temporary uses are permitted subject to approval of a Temporary Use Permit (TUP) application:
  - a. Temporary construction facility during construction;
  - b. Temporary homefinders information center;



- c. Temporary real estate offices and model homes located within a subdivision, to be used only for and during the original sale of the subdivision.
  - d. Other uses not mentioned shall be subject to P.M.C. 19.29 (Temporary Uses).
8. The following uses are prohibited
- a. Commercial Uses.
  - b. Industrial Uses.
  - c. Large Animals
  - d. Monopoles or similar wireless communications towers or facilities.
  - e. Storage Structures greater than 120 square feet in size.

**3.4.2 Development Standards**

Table 3-1 depicts the Multi-Family Development Standards

**[Table 3-1 Multi-Family Development Standards]**

Development Standard	Apartments	Townhomes	Small Lot Detached Single-Family	Single Family Court
Maximum Building Height	45 feet or 3 Stories	35 feet or 2 Stories	35 feet or 2 Stories	35 feet or 2 Stories
Minimum Lot Size	10,000 square feet	2,000 square feet	2,000 square feet	n/a <sup>1</sup>
Minimum Dwelling Area Required (livable area)	800 square feet	1,200 square feet	1,500 square feet	1,500 square feet
Minimum Lot Width	35 feet	25 feet	30 feet	n/a <sup>1</sup>
Minimum Front Yard Setback <sup>2</sup>	10 feet	10 feet	5 feet	n/a <sup>1</sup>
Minimum Side Yard Setback <sup>2</sup>	10 feet	n/a <sup>1</sup>	5 feet	5 feet
Minimum Rear Yard Setback <sup>2</sup>	10 feet	10 feet <sup>3</sup>	10 feet <sup>4</sup>	10 feet <sup>5</sup>
Minimum Distance Between Buildings	20 feet	10 feet	10 feet	10 feet
Minimum Usable Private Open Space	150 square feet/ 75 square feet <sup>6</sup>	10'x15'	200 square feet <sup>7</sup> Average	200 square feet <sup>8</sup> Average
Maximum Floor Area Ratio	2.0	1.5	1.5	n/a <sup>1</sup>
Maximum Lot Coverage	60%	n/a <sup>1</sup>	60%	n/a <sup>1</sup>

<sup>1</sup> Due to the irregular shape of the product, this standard does not apply.

<sup>2</sup> Encroachments into required setbacks in the MFR Residential Zone, including but not limited to architectural projections and first floor porches are subject to P.M.C. 19.02.060.

<sup>3</sup> No setback required in alley-loaded units.

<sup>4</sup> Units with Private Open Space parallel to the Rear Setback shall have a minimum rear yard of 10 feet. Units with Private Open Space in the Front or Side Setback shall have a minimum rear yard of 5 feet. No setback required in alley-loaded units.

<sup>5</sup> Units with Private Open Space parallel to the Rear Setback shall have a minimum rear yard of 10 feet. Units with Private Open Space in the Front or Side Setback shall have a minimum rear yard of 5 feet. No setback required in alley-loaded units.

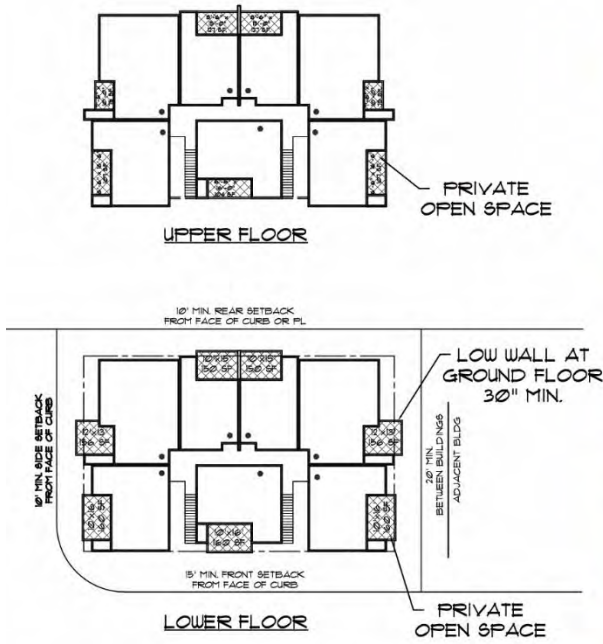
<sup>6</sup> Ground floor units shall have a minimum 150 square feet. Upper floor units shall have a minimum 75 square feet.

<sup>7</sup> Small Lot Detached Single Family Units shall average 200 square feet of Usable Private Open Space with a minimum of 150 square feet.

<sup>8</sup> Single Family Court Units shall average 200 square feet of Usable Private Open Space with a minimum of 150 square feet.



2-STORY

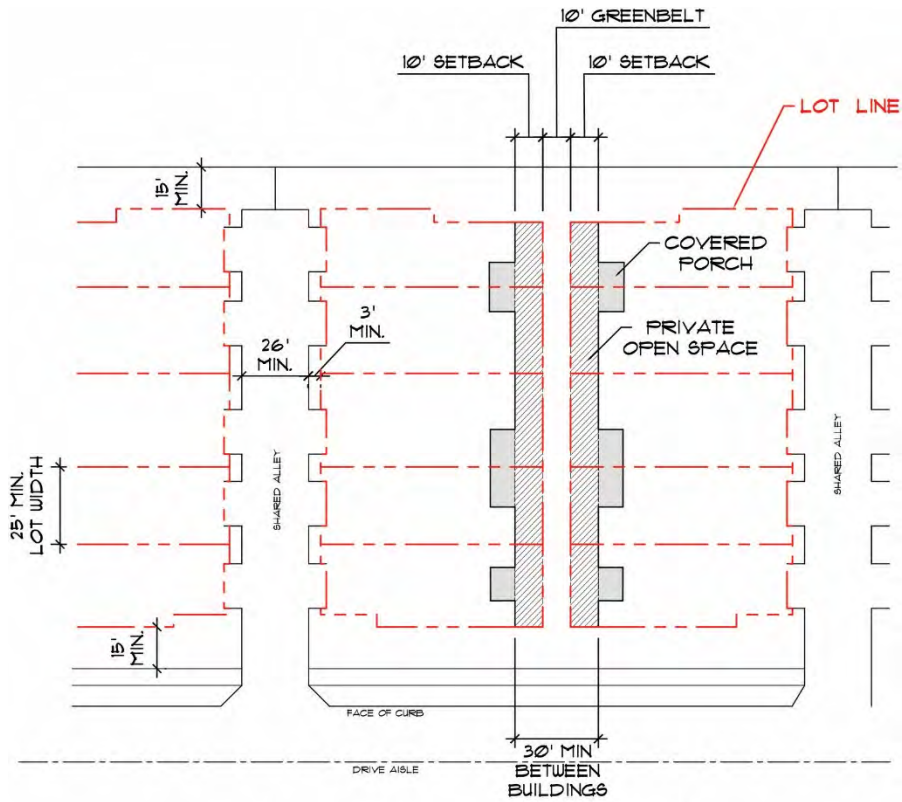


MIN. BUILDING SITE AREA - 3,000 SF  
 MIN. DWELLING (LIVABLE) AREA - 800 SF  
 MAX. LOT COVERAGE - 60%

TYPICAL LOT DETAIL  
 (APARTMENTS)  
 N.T.S.

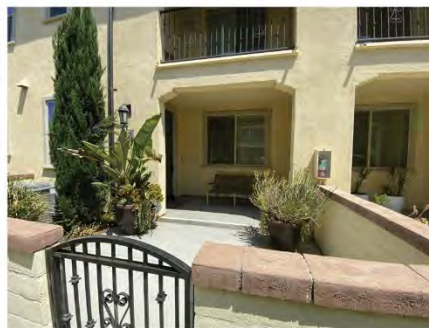
3-STORY



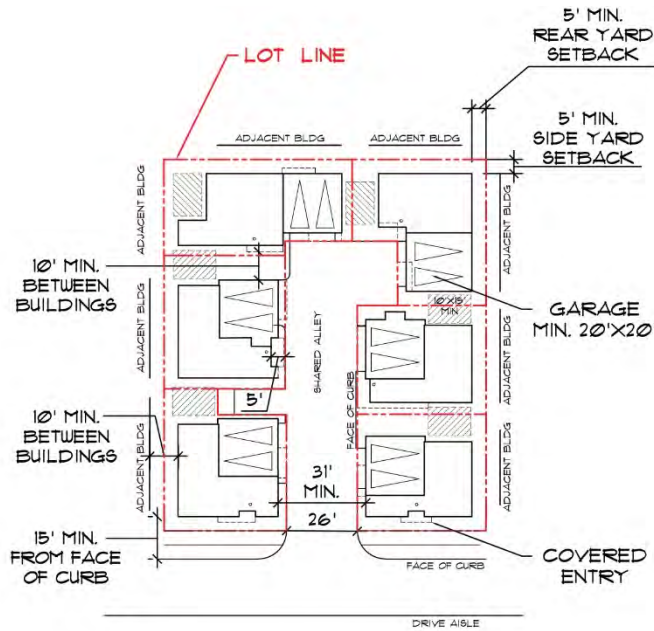


MIN. DWELLING (LIVABLE) AREA- 1,200 SF

**TYPICAL LOT DETAIL**  
(TOWNHOMES)  
N.T.S.







MIN. DWELLING (LIVABLE) AREA- 1,500 SF

Note: Units with Private Open Space parallel to the Rear Setback shall have a minimum rear yard of 10 feet. Units with Private Open Space in the Front or Side Setback shall have a minimum rear yard of 5 feet. No setback required in alley-loaded units.

TYPICAL LOT DETAIL  
(SINGLE FAMILY COURT)  
N.T.S.





**Multiple Projects Within One Planning Area:** Multiple developments and product types are allowed within a single Multiple Family Planning Area as long as the total number of dwelling units does not exceed the maximum units allowed for the Specific Plan.

**Multiple Family Dwelling Units Open Space Requirements:** All multiple-family dwelling units constructed in the Multi-Family Residential Zone shall provide private and common open space for the enjoyment of their residents in accordance with the following requirements:

1. Private Open Space:
  - a. Each individual ground floor unit shall be provided with a minimum of one hundred fifty (150) square feet of contiguous and usable outdoor living space, inclusive of any front yard, which shall be enclosed by a solid fence, wall or other approved screening, at a minimum of thirty (30) inches in height and the rectangle inscribed within such private open space shall not have a dimension less than ten (10) feet. Private open space for ground floor dwelling units may be covered entirely by an overhanging balcony or patio roof. Patios and balconies may be included in the calculation of private open space.
  - b. Each individual dwelling unit of a multi-family dwelling having no ground floor living area shall be provided with a minimum of seventy-five (75) square feet of aboveground private open space and the rectangle inscribed therein shall have no dimension less than five (5) feet. All above-ground private open space shall have at least one (1) exterior side open above the railing height.
  - c. Each square foot of private usable open space provided beyond the minimum requirements of this section shall be considered equivalent to one and one-half (1 1/2) square feet of the required common open space provided in the multiple-family dwelling project other than in the common pool area. In no case shall private open space constitute more than forty percent (40%) of the total required common open space of the project.
2. Common Open Space: Each unit of a multiple-family dwelling shall be provided with a minimum of one hundred fifty (150) square feet of common open space, exclusive of driveways, sidewalks and parking areas. Portions of yards (excluding the front yard and private open spaces) which are contiguous to all units in a multiple-family complex, pools, paved recreation areas and indoor recreational facilities may be included in the calculation of common open space. Not less than thirty percent (30%) of the required open space shall be in permanent landscaping. Such landscaping shall be comprised of live plant materials with permanent irrigation facilities and automatic timers installed.

**Single Family Detached Open Space Requirements:** Single Family Detached projects shall average two hundred (200) square feet of private open space per unit, with each unit containing a minimum of one hundred fifty (150) square feet of contiguous and usable outdoor living space, inclusive of any front yard, which shall be enclosed by a solid fence, wall or other approved screening, at a minimum of thirty (30) inches in height and the rectangle inscribed within such private open space shall not have a dimension less than ten (10) feet.

**Fences, Walls and Screening:** Fencing, walls or screening requirements in the Multi-Family Residential Zone shall be as follows:



1. Fences, walls or screening may be erected, constructed or positioned upon any lot parcel of land. Fences shall not exceed six (6) feet in height, measured from the highest adjacent elevation along the side and rear lot line, nor three (3) feet in height along the front yard lot line and that portion of the side yard lot line from the front lot line to the front setback distance;
2. Walls shall not exceed six (6) feet in height measured from the highest adjacent elevation along the side and rear yard lot lines nor three (3) feet in height along front yard lot lines and that portion of the side yard line from the front lot line to the front setback distance.
3. There shall be no height limitation upon screening through the use of natural vegetation, and all such screening shall be positioned as to ensure a minimum open visibility of fifty percent (50%) along the portion of the front yard line and the portion of the side yard line from the front yard line to the front setback distance. In no case shall natural vegetation employed provide less than fifty percent (50%) open visibility along the side and front yard lines for a distance of fifty (50) feet on any corner lot or parcel of land closest to a public street or thoroughfare. Trees shall be planted a minimum of five (5) feet distant from any property line.
4. In no case shall fences, walls or screening employed provide less than fifty percent (50%) open visibility along the side and front yard lines for a distance of fifty (50) feet on any corner lot or parcel of land closest to a public street or thoroughfare.
5. Nothing contained herein shall preclude the owner of multi-family residential property from constructing internal fences which meet height and other requirements.
6. All fencing/walls facing a public right of way, easement, trail, private alleyway, or internal streets shall provide a decorative block wall with a wrought iron or vinyl gate.
7. All other wall and fencing requirements not mentioned are subject to P.M.C. 19.02 (General Provisions).

**Temporary Advertising Structures:** The advertising structures permitted in the Multi-Family Residential Zone shall be as follows:

1. One (1) temporary unlighted sign, not exceeding six (6) square feet in area, pertaining only to the sale, lease or hire of only the particular building, property or premises upon which displayed.
2. Name plates not exceeding two (2) square feet in size, containing name and occupation of occupant of premises.
3. One (1) subdivision sign not exceeding one hundred (100) square feet in area, displayed upon the subdivision property.
4. One (1) temporary contractor sign not exceeding thirty-two (32) square feet in area, displayed upon the property on which construction is being performed.
5. Banners and flags not exceeding thirty-five (35) feet in height and limited to one (1) flag or banner for every thirty (30) feet of street frontage.
6. One (1) directional sign not exceeding two (2) square feet shall be permitted at each intersection within the complex.



7. All other advertising temporary signage are subject to P.M.C. 19.75, specifically P.M.C. 19.75.140.

**Parking Requirements:** The parking requirements in Multi-Family Residential Zone shall be as follows, and shall conform to the City of Perris parking requirements:

1. Parking shall be screened from street view and adjacent developments by a berm and/or wall (minimum of three [3] feet in height), or with landscaping.
2. Lights illuminating a parking space shall be arranged and screened to reflect light away from adjoining residences and streets. Lights shall be a maximum height of sixteen (16) feet.
3. Off-street parking areas shall be surfaced with permanent paving per soil engineer recommendations.
4. Parking spaces and driveways shall be arranged to require ingress and egress from the lot to a street by forward motion of the vehicle.
5. Off-street parking spaces shall be connected with a public street by a paved driveway which affords safe and convenient ingress and egress. A minimum width of driveways shall be twenty-six (26) feet if ingress and egress are the same. If ingress and egress are separate drives, then the minimum width shall be thirteen (13) feet.
6. All required parking spaces shall be located on a lot, or on a contiguous lot, upon which the use is located. Required parking spaces shall not be located on an adjacent lot in another zone.
7. Tandem parking spaces are permitted for three-car garages.
8. Attached Residential Spaces Required: Two (2) spaces per unit, one (1) within a garage.
9. Apartments Spaces Required: One (1) space per unit shall be within a carport or an enclosed garage (per P.M.C. 19.69 Parking and Loading Standards):

One-bedroom or studio unit	1.5 spaces
Two-bedroom unit	2 spaces
Three bedroom or more unit	2.5 spaces

A ten percent (10%) reduction in the total number of required apartment spaces may be granted as a Minor Adjustment per P.M.C. 19.54 Authority and Review Procedures for the provision of additional amenities.

10. Additionally, off-street parking shall be provided at a rate of one (1) space for every five (5) units in the development to accommodate visitor parking.
11. There shall be handicapped parking spaces provided at a rate of one (1) space for each forty (40) required spaces.
12. Parking for recreational amenities shall be in addition to that required for residential units. One space per two hundred fifty (250) square feet of recreational building amenity shall be provided in addition to the required residential and visitor spaces.
13. All landscaping within the parking areas shall conform with the standards and requirements of the City Perris Zoning Ordinance.





14. All other parking regulations are subject to P.M.C. 19.69 (Parking and Loading Standards)

**Architectural and Landscape Design Standards:** All new construction and additions are subject to Chapter 4, Design Guidelines and P.M.C. 19.70 (Landscaping).

**Standards not Addressed:** Standards not addressed shall in the Green Valley Specific Plan shall be pursuant to MFR-14 standards (P.M.C. 19.26).

**Authority and Review:** Authority and review procedures are subject to P.M.C. 19.54 (Authority and Review Procedures). Please note that the Planning Commission is the approval authority for Tentative Parcel Map (TPMs) and Tentative Tract Maps (TTMs) unless processed concurrently with an SPA.

**Multi-Family Dwellings Required Amenities:** The city council may reduce the following special required amenities for affordable housing or seniors housing. The city council may also approve alternative facilities appropriate to the type of development, in lieu of the following requirements, if a finding is made that equivalent standards, amenities, or facilities are provided.

1. General. All multi-family housing developments shall provide recreational amenities within the site in accordance with the following:

Amenity Required	Project Size
Tot lot with play equipment	5 units
Barbecue area with seating	10 units
Swimming pool and spa	20 units
Court game facilities such as tennis, basketball, racquetball, bocce ball, or outdoor recreation equipment	50 units
Clubhouse	120 units

The above amenities are cumulative, so all of the required amenities for smaller projects shall also be required in addition to the specified amenity for the number of units.

2. Security. All multi-family housing developments shall be entirely fenced and gated around the perimeter of the site. Vehicular gates shall be designed and arranged to provide turn-around outside the gate for vehicles not obtaining entry to the development.

3. Community focal points. Projects containing more than 20 units require installation of at least one community focal point per project all focal points shall be located at the main entrances (facing the main entry way). The community focal point shall be designed to function as a central meeting place for use by project residents and shall consist of a plaza, courtyard, or other type of landmark feature. These areas should include shading, seating, and decorative features consistent with the style and design of the units, or may be enclosed to function as a recreation room or cabana. If enclosed, the structure shall be architecturally embellished to signify a focal point. The focal point shall be centrally located and accessible to all residents.

4. On-site storage. Each dwelling unit shall be provided a minimum of 400 cubic feet of private enclosed lockable storage space within the garage, carport or immediately adjacent to the dwelling unit.



5. Laundry facilities. Common laundry facilities or sufficient number and accessibility consistent with the Uniform Building Code shall be provided; or each dwelling unit shall be plumbed and wired for a washing machine and dryer.
6. Entry statement standards. Projects shall include vehicular and pedestrian entry statements which shall be consistent with the following:
  - a. Provide one visually dominant entry to the development which conveys a sense of arrival;
  - b. Entry statements shall provide an open view into the development with landscaping and project directories;
  - c. Design the entry to provide a transition from the outside to an internal visual focus, such as landscaping, a water feature, sculpture, or a building;
  - d. Entries shall contain textured or stamped concrete, decorative gates, and monumentation;
  - e. Special attention shall be given to hardscape and landscape treatments at the entry to enhance the overall image of the development. An entry statement shall consist of at least two of the following items:
    - i. Hardscape structure (trellis, decorative, low garden wall with berming, guardhouse, decorative gate);
    - ii. Specimen landscaping (large, distinctive vegetation, i.e., relocated Joshua trees) or mature trees, either flowering or native trees, or 24-inch box trees;
    - iii. Large boulder groupings;
    - iv. Water saving and easy maintenance fountains;
    - v. Monument signage with accompanying landscape and berming; or
    - vi. Other comparable installations.



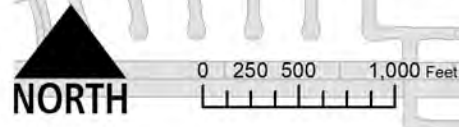
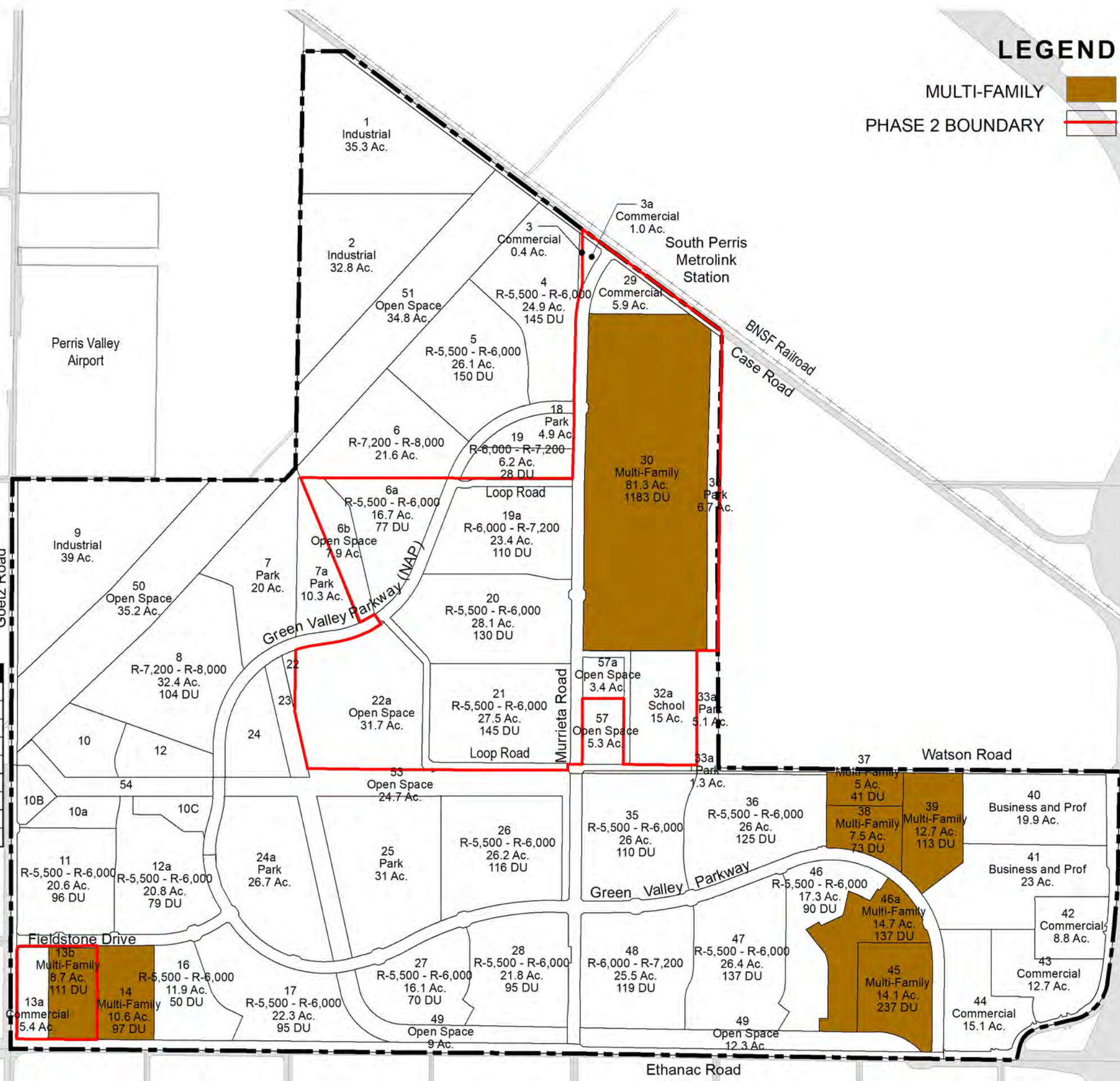
FIGURE 3-4

**LEGEND**

- MULTI-FAMILY
- PHASE 2 BOUNDARY

Note: Floodway compatible uses shall be allowed in planning areas impacted by the San Jacinto River floodway with CUP approval.

PA	Land Use	Ac.	DU
10	R-5,500 - R-6,000	9.4	40
10a	R-5,500 - R-6,000	5.0	16
10b	Open Space	2.9	
10c	Open Space	4.1	
12	R-5,500 - R-6,000	7.4	45
22	R-5,500 - R-7,200	0.8	4
23	Open Space	4.4	
24	R-5,500 - R-7,200	9.5	42
54	Open Space	7.9	



MULTI-FAMILY RESIDENTIAL



### 3.5 RETAIL COMMERCIAL STANDARDS

Planning Areas 3, 3a, 13a, 29, 42, 43, and 44

(Figure 3-5)

#### 3.5.1 Permitted Uses: The uses permitted in the Retail Commercial shall be as follows (Uses are defined per Section 3.10 and P.M.C. 19.08 (Definitions)):

1. Retail businesses or service establishments including, but not limited to, the following:
  - a. Bakeries, not including the wholesale baking or bakery goods to be sold off the premises;
  - b. Banks and other financial institutions;
  - c. Barbers and/or beauty shops;
  - d. Bookstores and newsstands;
  - e. Childcare Facilities. All childcare facilities are subject to P.M.C. 19.83.
  - f. Confectionery stores;
  - g. Conservatories for instruction in music and the arts;
  - h. Delicatessens, or meat, fish or poultry stores;
  - i. Department stores;
  - j. Drugstores, dry goods or notion stores;
  - k. Florist and gift shops;
  - l. Fruit, vegetable and fruit juice stores;
  - m. Grocery stores;
  - n. Hardware and electric appliance stores;
  - o. Health food stores;
  - p. Hotels and motels;
  - q. Jewelry stores and watch repair shops;
  - r. Patio and garden supply sales;
  - s. Pet stores, clinics and grooming shops;
  - t. Philanthropic and charitable institutions;
  - u. Photographic or camera stores;
  - v. Printing and copying establishments;
  - w. Private postal and package delivery service facilities;
  - x. Radio and television sales and repair;
  - y. Restaurants, cafes, cocktail lounges, fast-food establishments, and bars, without drive-through services;
  - z. Retail dry-cleaning establishments;
  - aa. Self-service laundries;
  - bb. Shoe stores and shoe repair shops;
  - cc. Sporting goods stores and sporting goods repair shops;





- dd. Sports facilities, including bowling alleys, golf training facilities, video game centers, amusement parlors and related activities;
  - ee. Stationery stores;
  - ff. Tailors, dressmakers and wearing apparel stores;
  - gg. Theaters;
  - hh. ;
  - ii. Child Care Facilities. Small Family Day Care facilities subject to P.M.C. 19.83;
  - jj. Residential Care Facilities. Residential care facilities subject to P.M.C. 19.84; and
  - kk. Other uses deemed to be similar and compatible by the City of Perris Planning Director.
2. Offices for administrative, business professional or design professional offices.
3. The following conditional uses are permitted subject to approval of a Conditional Use Permit (CUP) application per P.M.C. 19.61 (Conditional Use Permits)
- a. Automobile service stations and automobile repair facilities;
  - b. Car washes and Drive-thru automated carwashes;
  - c. Hospitals, urgent care facilities, skilled nursing facilities, and related uses;
  - d. Liquor and convenience stores;
  - e. Restaurants with drive-through services;
  - f. Publicly owned museums, libraries, community centers, governmental offices and recreation areas; institutions of religious, educational or philanthropic nature; private clubs, lodges, or veterans' organization;
  - g. Recycling centers pursuant to P.M.C. 19.76;
  - h. Solar farm;
  - i.
  - j. Child Care Facilities. Large Family Day Care and Child Care Centers subject to P.M.C. 19.83.
4. All other uses that require a CUP as mentioned per P.M.C. 19.38 Commercial Community Zone. All other non-industrial land uses not mentioned determined to require a CUP by the Planning Director or Director of Development Services.
5. In addition, the following accessory uses customarily incident to any of the above uses shall be permitted:
- a. Flags, pennants or insignia of a nation, state, county, city, political unit, church or religious organization;
  - b. Works of fine art not displayed in conjunction with a commercial enterprise deriving commercial gain from such display.

**3.5.2 Prohibited Uses:** No enterprise and/or industrial uses are permitted in the Retail Commercial Zone which produces or causes any dust, smoke, gas, noise, fumes, odors, or vibrations which are or may be detrimental to other property in the neighborhood or to the welfare of the occupants thereof.



### 3.5.3 Development Standards

**Building Height Unit:** The maximum building height limit in-the Retail Commercial Zone shall be fifty (50) feet or two (2) stories.

**Lot Size Requirement:** There shall be no minimum building size requirement in the Retail Commercial Zone. Commercial building sites will be master planned, and no building site shall be less than ten thousand (10,000) square feet.

**Width of Lot:** Minimum lot width shall be 100 feet.

**Front Yard Setback Required:** The requirement for front yards in the Retail Commercial Zone shall be not less than twenty-five (25) feet in depth, measured from the curb line, which is to be fully landscaped and not otherwise utilized.

**Side Yard Required:** There shall be a fifteen (15) foot minimum requirement for side yards in the Retail Commercial Zone. Where adjoining a street, this requirement shall be twenty-five (25) feet, as measured from the curb line, with no intrusions and shall be fully landscaped.

**Rear Yard Required:** The requirements for rear yards in the Retail Commercial Zone shall be not less than eighteen (18) feet in depth, or for each building a yard:

1. Which is adjacent to and extends the full length of all rear sides thereof;
2. Which is not less than ten (10) feet in depth; and
3. Which is accessible to an alley, street, or public thoroughfare.

Where the site adjoins land which is residentially zoned or used, a fifty (50) foot building setback is required. This setback shall be fully landscaped to a depth of twenty and one half (20.5) feet.

Where the rear yard adjoins a street, the minimum setback shall be twenty-five (25) feet as measured from the curb line with no intrusion. Said area shall be fully landscaped.

**Projects with Multiple Buildings:** Commercial projects with multiple lots that are contiguous and tied together by a development agreement, planned development overlay, cross-access and/or shared-parking agreements, or similar covenant approved by the city and formally recorded against title may deviate from the lot size, lot width, lot depth, and street frontage criteria provided that such deviation is necessary to achieve superior site planning. Such developments are required to submit a sign program to ensure consistent signage throughout the project site and to address monumentation signage along street frontages. Also, projects that employ shared parking agreements may spread the required parking supply across multiple parcels, in compliance with P. M. C. Section 19.69.030(b)(5) (Shared Parking Provisions).

**Distance Between Buildings:** There shall be no minimum requirement in the Retail Commercial Zone except that no detached dwelling shall be less than fifty (50) feet from any dwelling.

**Lot Coverage:** The maximum permissible building coverage by any structure in the retail Commercial Zone shall be fifty percent (50%) of the lot or lots.

**Fences, Walls or Screening:** The requirement for fences, walls or screening in the Retail Commercial Zone shall be as follows:

1. Fences, walls or screening providing a minimum six (6) feet of height may be erected along the property boundaries of lots or parcels of land whose use is retail commercial on all



such properties or portions thereof, where such construction is feasible due to visibility restrictions for motorists.

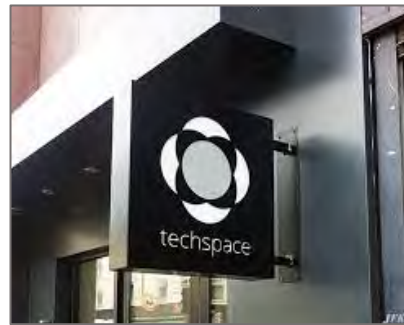
2. Solid fencing, wall or screening shall be required whenever a Retail Commercial property abuts any residential-zoned property.
3. Screening through natural vegetation may be provided; however, vegetation used shall achieve mature growth equal to the required six (6) foot minimum and shall have a permanent irrigation system installed.
4. All fencing/walls facing a public right of way, easement, trail, private alley way, or internal streets shall provide a decorative block wall with a wrought iron or vinyl gate.
5. All other wall and fencing requirements not mentioned are subject to P.M.C. 19.02 (General Provisions).

**Advertising Structures:** The advertising structures permitted in the Retail Commercial Zone shall be as follows:

1. All signage not mentioned is subject to P.M.C. 19.75 (Sign Regulations) and all temporary signage is subject to P.M.C. 19.60 (Temporary Activities and Uses).
2. For each commercial unit face provided, one (1) exterior sign attached to the building be installed. (The City Planning Department shall review plans submitted to determine and designate commercial unit faces.) The area of each sign shall not exceed a ratio of one (1) square foot of sign to one (1) linear foot of commercial unit face to a maximum sign size of one hundred fifty (150) square feet. Each sign shall be of the variety hereafter described:
  - a. Lighted or electrical sign pertaining to product and establishment of identification;
  - b. Projecting sign; provided, that projection shall not exceed one (1) inch projection per each inch of ground clearance above eight (8) feet;
  - c. Marquee/canopy signs shall be limited to identifying the use of the premises and address only;
  - d. Wall signs;
  - e. Temporary banners not to exceed one hundred (100) square feet in area and to be displayed for only thirty (30) consecutive days within a twelve (12) month period;
  - f. Signs shall be placed on the building in which the uses referred to take place, or placed on canopies attached to the building in which the uses referred to take place;
  - g. Signs attached to and parallel with the walls of the building shall not extend above the roof of the building.
3. Necessary hazard, direction sign or regulatory signs within the complex area.

Signs posted to indicate handicapped parking and loading spaces.







4. Signs posting the periphery of the complex provided such signs shall not exceed ten (10) square feet in area for each sign and shall be limited to one (1) sign for each two hundred (200) feet of lot line.
5. No cabinet signs, roof-mounted signs, pennant flags, or pole signs are permitted and any other sign prohibited per P.M.C. 19.75 (Sign Regulations)

**Parking Requirements:** Parking within the Retail Commercial Zone shall be consistent with the Non-residential regulations of Chapter 19.69, Parking and Loading Standards of the Perris Municipal Code.

**Landscaping of Parking Areas:** The requirement for landscaping in parking areas in the Retail Commercial Zone shall be consistent with Chapter 4, Design Guidelines, P.M.C. 19.70 (Landscaping), and as follows:

1. A minimum of fifteen percent (15%) of the parking area shall be landscaped with live plant material, including but not limited to, trees, shrubs and ground cover. All trees planted shall be fifteen (15) gallon in size or larger, with a caliber of at least two (2) inches.
2. The landscaping shall be evenly distributed throughout the parking area with at least one (1) shade tree for every six (6) parking spaces.
3. All landscaped areas shall be provided with permanent, automatic irrigation facilities.
4. All landscaping plans shall be prepared by a registered landscape architect.

**Landscaping of Setbacks:** The requirement for landscaping in front, side and rear yards required in Retail Commercial Zone shall be consistent with Chapter 4, Design Guidelines, P.M.C. 19.70 (Landscaping), and as follows:

1. All front, side and rear yards required shall be landscaped with live plant material including, but not limited to, trees, shrubs and ground cover. All landscaped areas shall be provided with permanent, automatic irrigation facilities. All landscaping plans shall be prepared by a registered landscape architect
2. Notwithstanding the requirements of Subsection 1, above, the landscaping requirements of this Section may be waived by the City in the event the proposed development is located on a rear or side yard lot line.

**Cell Towers:** Cell towers shall meet the requirements of P.M.C. Chapter 19.85 (Wireless Telecommunication Facilities).

**Architectural Design Guidelines:** All new construction and additions are subject to Section 4.3, Commercial, Business and Professional, and Light Industrial Guidelines.

**Authority and Review:** Authority and review procedures are subject to P.M.C. 19.54 (Authority and Review Procedures). Please note that the Planning Commission is the approval authority for Tentative Parcel Map (TPMs) and Tentative Tract Maps (TTMs) unless processed concurrently with an SPA.





FIGURE 3-5

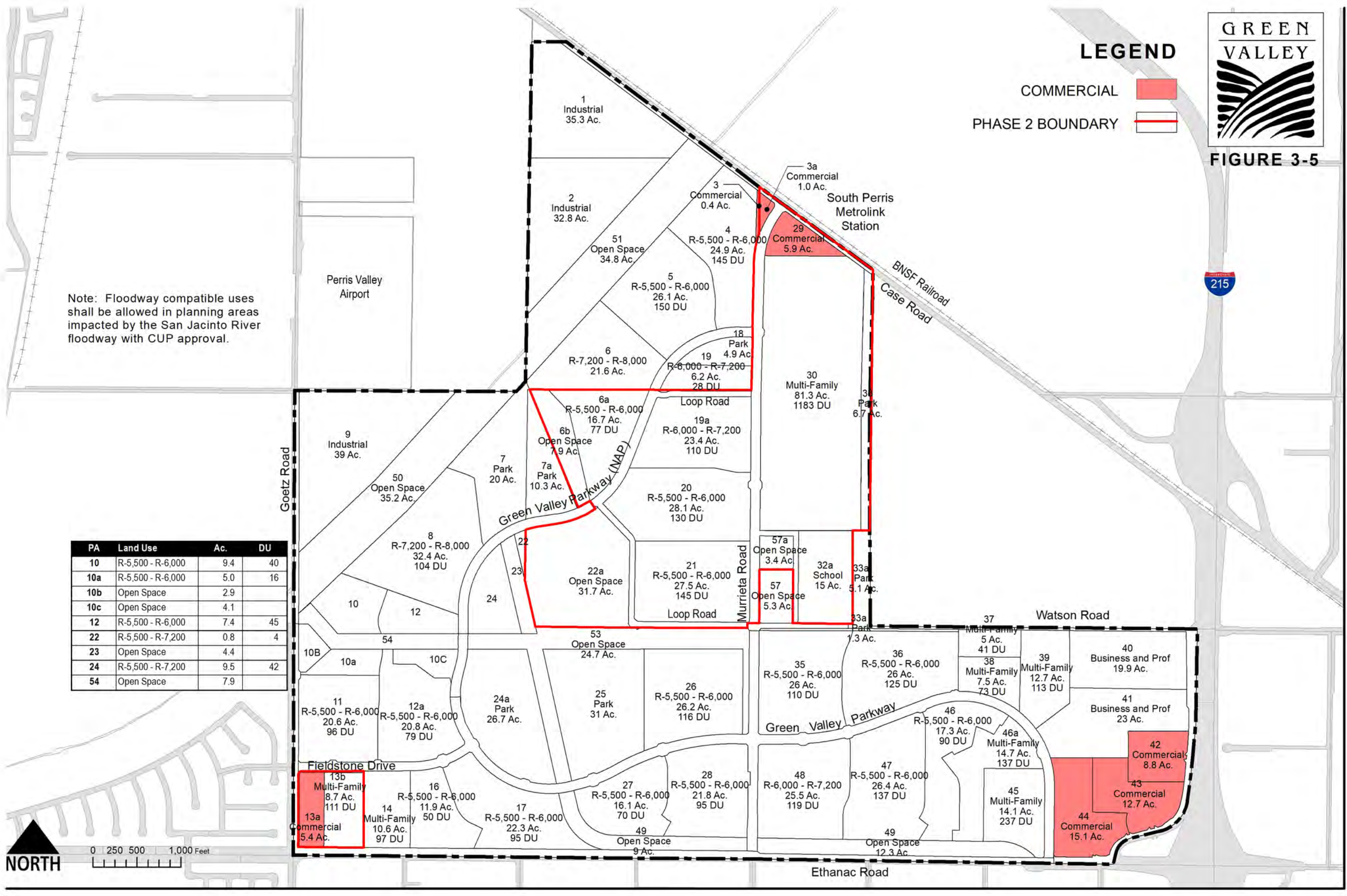
**LEGEND**

- COMMERCIAL
- PHASE 2 BOUNDARY

**COMMERCIAL**

Note: Floodway compatible uses shall be allowed in planning areas impacted by the San Jacinto River floodway with CUP approval.

PA	Land Use	Ac.	DU
10	R-5,500 - R-6,000	9.4	40
10a	R-5,500 - R-6,000	5.0	16
10b	Open Space	2.9	
10c	Open Space	4.1	
12	R-5,500 - R-6,000	7.4	45
22	R-5,500 - R-7,200	0.8	4
23	Open Space	4.4	
24	R-5,500 - R-7,200	9.5	42
54	Open Space	7.9	







### 3.6 BUSINESS/PROFESSIONAL STANDARDS

Planning Areas 40 and 41

#### 3.6.1 Permitted Uses: All uses in Section 3.5.1, in addition to the uses permitted in Business/Professional shall be as follows:

1. Advertising agencies;
2. Arts and crafts studios, subject to the following conditions:
  - a. That the major character of such studios be that of providing a service;
  - b. That any equipment or apparatus used on the premises be of a scale and construction that facilitate easy handling and operation by nonprofessionals.
3. Banks, savings and loans, and other financial institutions.
4. Barber shops and beauty salons.
5. Coin, stamp, and other hobby shops.
6. Employment agencies.
7. Escrow offices.
8. Hospitals and urgent care facilities.
9. Libraries.
10. Medical and dental buildings; prescription pharmacies; dental, biochemical and x-ray laboratories; and related facilities.
11. Post offices, and package shipment centers.
12. Professional offices for accountants; attorneys; doctors, dentists, optometrists, oculists, chiropractors, and others licensed by the state to practice the healing arts; planners, engineers and architects.
13. Public utility commercial offices.
14. Real estate, insurance and stockbrokers.
15. Reducing, exercising, or tanning salons.
16. Skilled nursing facilities.
17. Studios: interior decorating, photographer, couturier, artist, and music.
18. Telephone answering and secretarial services.
19. Travel agencies.
20. Similar business and professional offices and related services when interpreted by the Planning Director as consistent with the purpose and intent of the Business/Professional zoning classification.
21. Child Care Facilities. Small Family Day Care facilities subject to P.M.C. 19.83.
22. Residential Care Facilities. Residential care facilities subject to P.M.C. 19.84.
23. All other Business Park uses not mentioned but allowed per P.M.C. 19.44.



24. In addition, the following uses shall be permitted provided that a conditional use permit is first obtained:
  - a. Churches, and other places of worship.
  - b. Child Care Facilities. Large Family Day Care and Child Care Centers subject to P.M.C. 19.83.
  - c. Fire and police stations.
  - d. Private clubs, fraternities, sororities, lodges, and non-profit organizations.
  - e. Public parking areas, subject to the following conditions:
    - i. That such area shall be for the temporary parking of automobiles without monetary charge except when operated by, or for, a public parking authority;
    - ii. That such lot shall abut a lot zoned for commercial uses or an intervening alley, and that it shall be shown that such parking is to be used to provide the parking needs of such abutting commercially zoned lot;
    - iii. That no such parking area shall be used for a used car sales area or for the accessory storage of cars;
    - iv. That a minimum fifteen percent of the parking lot area shall be landscaped.
  - f. Surgical supply sales.
  - g. All other Business Park uses requiring a conditional use permit not mentioned but allowed per P.M.C. 19.44.

**3.6.2 Prohibited Uses: The following uses are prohibited in Business/Professional:**

1. Any enterprise which produces or causes any dust, smoke, gas, noise, fumes, odors, or vibrations which are or may be detrimental to other property in the neighborhood or to the welfare of the occupants thereof.
2. Any use, except parking, which is not conducted wholly within an enclosed building.
3. Storage, except that which is wholly within an enclosed building.
4. The manufacture of any product for sale at off-premises, except as permitted by conditional use permit.

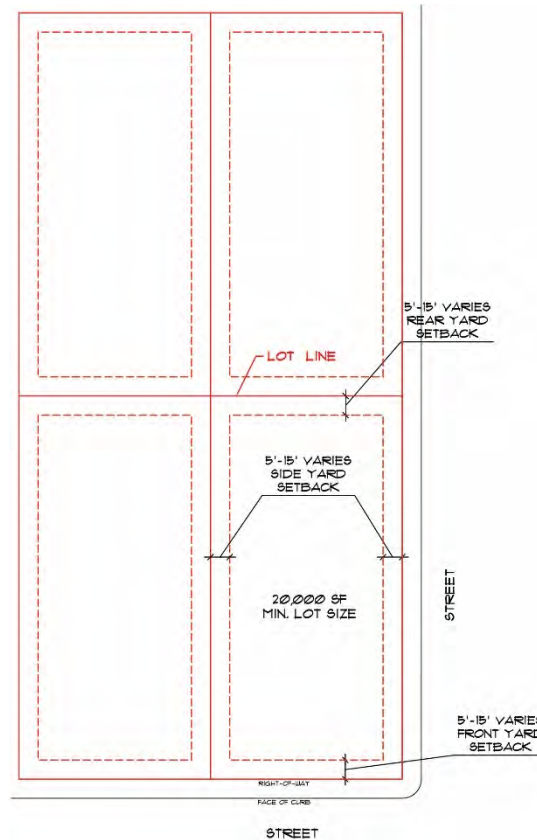
**3.6.3 Development Standards**

**Minimum Lot Size:** The minimum lot size shall be twenty thousand (20,000 square feet).

**Building Height Limit:** The maximum building height limit in the Business/Professional Zone shall be fifty (50) feet.

**Width of Lot:** The minimum lot width in the Business/Professional Zone shall be one hundred (100) feet.

**Front Yard Required:** The requirement for front yards in the Business/Professional Zone shall be not less than five (5) feet from local/collector streets, ten (10) feet from arterials, and fifteen (15) feet from expressways and freeways.



**Side Yard Required:** There shall be no minimum requirement for side yards in the Business/Professional Zone adjoining non-residential land uses. Where the side yard adjoins a street, the minimum setback shall be five (5) feet from local/collector streets, ten (10) feet from arterials, and fifteen (15) feet from expressways and freeways.

Where the side yard adjoins residential uses or residentially zoned land, the setback shall be minimum of ten (10) feet, unless adjacent to loading or unloading areas, in which case it shall be a minimum of fifty (50) feet.

**Rear Yard Required:** The requirements for rear yards in Business/Professional Zone shall be the same as side yards.

**Distance Between Buildings:** There shall be no minimum requirement in the Business/Professional Zone.

**Projects with Multiple Buildings:** Business Park projects with multiple lots that are contiguous and tied together by a development agreement, planned development overlay, cross-access and/or shared-parking agreements, or similar covenant approved by the city and formally recorded against title may deviate from the lot size, lot width, lot depth, and street frontage criteria provided that such deviation is necessary to achieve superior site planning. Such developments are required to submit a sign program to ensure consistent signage throughout the project site and to address monumentation signage along street frontages. Also, projects that employ shared parking agreements may spread the required parking supply across multiple parcels, in compliance with P. M. C. Section 19.69.030(b)(5) (Shared Parking Provisions).





**Fences, Walls or Screening:** The requirement for fences, walls or screening in the Business/Professional Zone shall be as follows:

1. Fences, walls or screening providing a minimum six (6) feet of height may be erected along the property boundaries of lots or parcels of land whose use is retail commercial on all such properties or portions thereof, where such construction is feasible.
2. Solid walls shall be required whenever a Business/Professional property abuts any residential-zoned property. Where property adjoins residential uses the minimum setback shall be fifty (50) feet of which a minimum of twenty (20) feet shall be landscaped adjacent to the property line with no building encroachments.
3. Screening through natural vegetation may be provided; however, vegetation used shall achieve mature growth equal to the required six (6) foot minimum and shall have a permanent irrigation system installed to ensure growth.
4. All other wall and fencing requirements not mentioned are subject to P.M.C. 19.02 (General Provisions).

**Sign Regulations:** Signage within the Business/Professional Zone shall be pursuant to P.M.C. 19.75 (Sign Regulations).

**Parking Requirements:** Parking requirements for the Business/Professional Zone shall be pursuant to P.M.C. 19.69 (Parking and Loading Standards).

**Landscaping of Parking Areas:** The requirement for landscaping in parking areas in the Business/Professional Zone shall be as follows:

1. A minimum of fifteen percent (15%) of the parking area shall be landscaped with live plant material, including but not limited to, trees, shrubs and ground cover. All trees planted shall be 15 gallon in size or larger with a caliber of at least two (2) inches.
2. The landscaping shall be evenly distributed throughout the parking area with at least one (1) shade tree for every six (6) parking spaces.
3. All landscaped areas shall be provided with permanent, automatic irrigation facilities.
4. All landscaping plans shall be prepared by a registered landscape architect.
5. Per the requirements of P.M.C. 19.70 (Landscaping).

**Landscaping of Setbacks:** The requirement for landscaping in front, side and rear yards required in Business/Professional Zone shall be as follows:

1. All front, side and rear yards required shall be landscaped with live plant material including, but not limited to, trees, shrubs and ground cover. All landscaped areas shall be provided with permanent, automatic irrigation facilities. All landscaping plans shall be prepared by a registered landscape architect.
2. Notwithstanding the requirements of Subsection 1, above, the landscaping requirements of this Section may be waived by the City in the event the proposed development is located on a rear or side yard lot line.

**Architectural Design Guidelines:** All new construction and additions are subject to Section 4.3, Commercial, Business and Professional, and Light Industrial Guidelines.

**Authority and Review:** Authority and review procedures are subject to P.M.C. 19.54 (Authority and Review Procedures). Please note that the Planning Commission is the approval authority for



Tentative Parcel Map (TPMs) and Tentative Tract Maps (TTMs) unless processed concurrently with an SPA.



### 3.7 LIGHT INDUSTRIAL STANDARDS

These Planning Areas are within the Western Riverside County Multiple Species Habitat Conservation Plan (MSHCP) Criteria Cell and are not yet approved nor entitled for the land uses identified from the original Green Valley Specific Plan. These Planning Areas require a consistency determination with the MSHCP as part of the entitlements process.

#### 3.7.1 Permitted Uses: The uses permitted in the Light Industrial Zone shall be the same as follows:

1. Wholesale business, fruit packing plants, sales and salvage yards, but not including auto wrecking or the sale of used or secondhand goods or merchandise; and including light indoor manufacturing, light industries, cabinet and wood working shops and metal working and light machine shops, but not including ferrous metal forging works.
2. Subject to conditional permit, open storage, landscape nurseries, swap meets (indoor or outdoor), and industrial manufacturing.

#### 3.7.2 Prohibited Uses: Uses prohibited in the Light Industrial Zone shall be any which cause or emit any dust, gas, smoke, odors, or vibrations which are or may be detrimental to other properties in the neighborhood or to the welfare of the occupants thereof. Also, schools, hospitals, residential uses.

#### 3.7.3 Development Standards

**Minimum Lot Size:** The minimum lot size shall be fifteen thousand (15,000 square feet).

**Building Height:** Building heights in the Light Industrial Zone shall not exceed twenty-four (24) feet or per the maximum height determined by the Airport Land Use Commission (ALUC)

**Width of Lot:** The minimum lot width requirement in the Light Industrial Zone shall be seventy-five (75) feet.

**Front Yard Required:** The requirements for front yards in the Light Industrial Zone shall be not less than ten (10) feet from local/collector streets and fifteen (15) feet from arterials.

#### **Side Yard Required:**

1. There shall be no minimum side yard requirement in the Light Industrial Zone adjoining non-residential zones.
2. Where the site adjoins a street, the minimum setback shall be not less than ten (10) feet from local/collector streets and fifteen (15) feet from arterials.
3. Where the site adjoins residentially zoned property the side yard setback shall be a minimum of twenty (20) feet, unless adjacent to loading or unloading areas, in which case it shall be a minimum of thirty (30) feet.

**Rear Yard Required:** The requirements for rear yards in the Light Industrial Zone shall be the same as side yards.

**Distance Between Buildings:** There shall be no minimum requirements for distance between buildings in the Light Industrial Zone except that no detached dwelling shall be less than ten (10) feet from any other dwelling or main building on the same building site; provided however, that such distance may be less than ten (10) feet and not less than five (5) feet if either such dwelling or main building has no opening on the side between the buildings.





**Screening:**

1. **Truck Courts:** Industrial operations and truck courts shall be screened from public view and adjacent residential uses with live plant material including, but not limited to, trees, shrubs and ground cover. All landscaped areas shall be provided with permanent, automatic irrigation facilities. All landscaping plans shall be prepared by a registered landscape architect.
2. **Outdoor Storage Permitted:** Outdoor storage is permitted as an accessory use in Light Industrial Zone (limited to 10% of the site or less).
3. **Outdoor Display Areas:** Outdoor display area of products covering less than 5% of the lot area is allowed upon approval of a Minor Development Plan Review by the Planning Department pursuant to Chapter 19.54. Outdoor display area of products covering more than 5% of the lot area is allowed upon approval of a Conditional Use Permit.

**Landscaping of Parking Areas:** The requirement for landscaping in parking areas in Light Industrial Zone shall be as follows:

1. A minimum of fifteen percent (15%) of the parking area shall be landscaped with live plant material, including but not limited to, trees, shrubs and ground cover. All trees planted shall be fifteen (15) gallon size or larger, with a trunk caliber of at least two (2) inches.
2. The landscaping shall be evenly distributed throughout the parking area with at least one (1) shade tree for every six (6) parking spaces.
3. All landscaped areas shall be provided with permanent, automatic irrigation facilities.
4. All landscaping plans shall be prepared by a registered landscape architect.
5. Per the requirements of P.M.C. 19.70 (Landscaping).

**Landscaping of Setbacks:** The requirement for landscaping in front, side and rear yards required in the Light Industrial Zone shall be as follows:

1. All front, side and rear yards required shall be landscaped with live plant material including, but not limited to, trees, shrubs and ground cover. All landscaped areas shall be provided with permanent, automatic irrigation facilities. All landscaping plans shall be prepared by a registered landscape architect.
2. Notwithstanding the requirements of Subsection 1, above, the landscaping requirements of this Section may be waived by the Planning Director in the event the proposed development is located on a rear or side yard lot line.

**Sign Regulations:** Signage within the Business/Professional Zone shall be pursuant to P.M.C. 19.75 (Sign Regulations).

**Architectural Design Guidelines:** All new construction and additions are subject to Section 4.3, Commercial, Business and Professional, and Light Industrial Guidelines.

**LEED.** All new industrial buildings will need to comply with Silver LEED status (certification is optional).

**Authority and Review:** Authority and review procedures are subject to P.M.C. 19.54 (Authority and Review Procedures). Please note that the Planning Commission is the approval authority for



Tentative Parcel Map (TPMs) and Tentative Tract Maps (TTMs) unless processed concurrently with an SPA.



### 3.8 PUBLIC FACILITIES STANDARDS

Planning Areas 7, 7a, 18, 24a, 25, 32a, 33, and 33a

(Figure 3-6)

#### 3.8.1 Permitted Uses: The uses permitted in the Public Facilities Zone shall be the same as follows:

1. Public parks.
2. Public school.
3. Public trails.
4. Other non-development uses in support of urban lifestyle which the Director of Development Services or designee interprets to be consistent with the purpose and intent of the Public Facilities zoning classification.

#### 3.8.2 Development Standards

**Building Site Area Requirement:** There shall be no minimum building site area requirement in the Public Facilities Zone.

**Width of Lot:** There shall be no minimum lot width requirement in the Public Facilities Zone.

**Building Setback from Public Street:** Minimum of ten (10) feet.

**Building setback from Residential Property Line:** Minimum of twenty-five (25) feet.

**Distance Between Buildings:** There shall be no minimum requirements for distance between buildings in the Public Facilities Zone.

**Landscaping of Parking Areas:** The requirement for landscaping in parking areas in the Public Facilities Zone shall be consistent with Chapter 4, Design Guidelines, P.M.C. 19.70 (Landscaping), and as follows:

1. A minimum of fifteen percent (15%) of the parking area shall be landscaped with live plant material, including but not limited to, trees, shrubs and ground cover. All trees planted shall be fifteen (15) gallon size or larger, with a trunk caliber of at least two (2) inches.
2. The landscaping shall be evenly distributed throughout the parking area with at least one (1) shade tree for every six (6) spaces.
3. All landscaped areas shall be provided with permanent, automatic irrigation facilities.
4. All landscaping plans shall be prepared by a registered landscape architect.

**Landscaping of Setbacks:** The requirement for landscaping in front, side and rear yards required in the Public Facilities Zone shall be consistent with Chapter 4, Design Guidelines, P.M.C. 19.70 (Landscaping), and as follows:

1. All front, side and rear yards required shall be landscaped with live plant material including, but not limited to, trees, shrubs and ground cover. All landscaped areas shall be provided with permanent, automatic irrigation facilities. All landscaping plans shall be prepared by a registered landscape architect





**3. Specific Plan Zoning**

2. Notwithstanding the requirements of Subsection 1, above, the landscaping requirements of this Section may be waived by the City in the event the proposed development is located on a rear or side yard lot line.

**Parking:** Parking within the Public Facilities Zone shall be consistent with the non-residential regulations of Chapter 19.69, Parking and Loading Standards of the Perris Municipal Code.

**Authority and Review:** Authority and review procedures are subject to P.M.C. 19.54 (Authority and Review Procedures). City of Perris sponsored projects are approved through Administrative Determinations. Please note that the Planning Commission is the approval authority for Tentative Parcel Map (TPMs) and Tentative Tract Maps (TTMs) unless processed concurrently with an SPA.



### 3.9 OPEN SPACE STANDARDS

Planning Areas 6, 6b, 10b, 10c, 22a, 23, 49, 50, 51, 53, 54, 57, and 57a.

(Figure 3-6)

#### 3.9.1 Permitted Uses: The uses permitted in the Open Space shall be as follows:

1. Open space.
2. Recreational uses.
3. Flood control structures.
4. Recreational trails.

#### 3.9.2 Prohibited Uses: Uses prohibited in the Open Space shall be any building, structure or sign, excepting those necessary for flood control or public safety in connection with the above permitted uses.



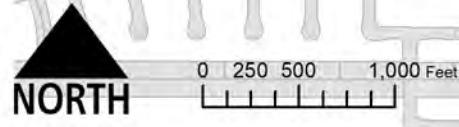
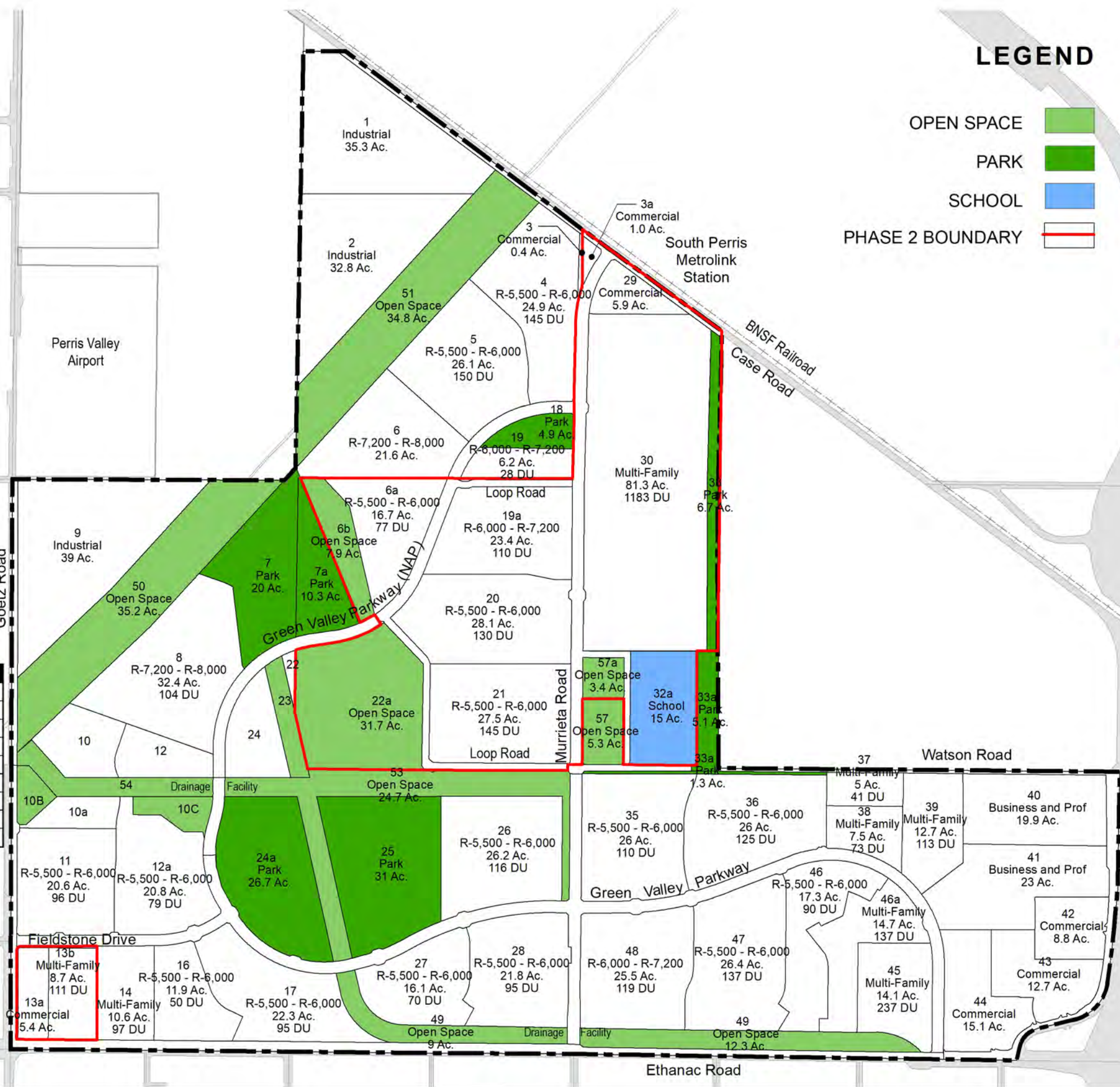
FIGURE 3-6

LEGEND

- OPEN SPACE
- PARK
- SCHOOL
- PHASE 2 BOUNDARY

Note: Floodway compatible uses shall be allowed in planning areas impacted by the San Jacinto River floodway with CUP approval.

PA	Land Use	Ac.	DU
10	R-5,500 - R-6,000	9.4	40
10a	R-5,500 - R-6,000	5.0	16
10b	Open Space	2.9	
10c	Open Space	4.1	
12	R-5,500 - R-6,000	7.4	45
22	R-5,500 - R-7,200	0.8	4
23	Open Space	4.4	
24	R-5,500 - R-7,200	9.5	42
54	Open Space	7.9	



PUBLIC FACILITIES • OPEN SPACE



**3.10 DEFINITIONS**

The following definitions shall apply to uses and accessory uses within in Green Valley Specific Plan. Uses not defined herein shall be as defined by P.M.C. 19.08 (Definitions).

- 3.10.1 Apartments** – means a building containing separate dwelling units for three or more families.
- 3.10.2 Average Rear Setback** – In order to provide for a variety of housing types and configurations, an average rear setback is used for the single-family residential development standards. The average rear setback is calculated using the lot width excluding required side setbacks.
- 3.10.3 Business/Professional Uses** – This zone provides for business and office uses where professional or clerical duties are performed such as business support services, legal services, collection agencies, development services office and property management services.
- 3.10.4 Childcare Facilities** – means any childcare facility of 13 or more children (other than a family child care home), and includes infant centers, preschool and extended child care facilities. Such a facility shall provide nonmedical services to children under 18 years of age in need of personal services, supervision or assistance essential for sustaining the activities of daily living or for the protection of the individual on less than a 24-hour basis.
- 3.10.5 Churches, Synagogues, and other Religious Places of Worship** – means an establishment, the principal purpose which is religious worship and including accessory uses in the principal structure or in separate buildings, including Sunday school rooms, assembly rooms, kitchen, library room, one-family dwelling unit and day nurseries operated by and on the church site, but excluding facilities for residence of or training of religious orders.
- 3.10.6 Commercial** – This zoning designation provides for retail, professional office, and service oriented business activities which serve the entire City, as well as the surrounding neighborhoods. This zone shall be applicable to and correlate with the General Plan Land Use designations of Community Commercial and Commercial Neighborhood.
- 3.10.7 Condominium** – A building or complex of buildings containing a number of individually owned apartments or houses.
- 3.10.8 Convalescent and Senior Home Facility** - means an institution rendering extended care, nursing, dietary and other personal services to convalescents, invalids or aged persons, in which surgery is not performed and primary treatment such as is customarily given in general hospitals is not provided.
- 3.10.9 Enclosed Patios** – An enclosed patio is an extension of a house that usually consists of some type of patio area closed off in some way from outdoor elements. It is often used for lounging, dining, and entertaining.
- 3.10.10 Grocery Store (Supermarket)**- means any retail store which provides food products, produce, household items and prepackaged alcoholic beverages as an incidental commodity to the establishment.
- 3.10.11 Hospitals** – Any building or portion thereof, used for the treatment or accommodation of injured or ill persons, and includes sanatoria, convalescent and rest homes and boarding homes for children and aged persons, also orphanages, but shall not include asylums, detention or similar buildings where human beings are housed or detained under legal restraint.





- 3.10.12 Hotels and Motels** – Buildings designed for or occupied by the temporary lodging of individuals in which there are 6 or more guest rooms for which there is no provision for cooking in any individual room or suite. Said use may also contain such ancillary facilities as conference facilities, personal services or food preparation and dispensing.
- 3.10.13 Landscape Nurseries** – Reproduction and growing of plants to usable size for retail or wholesale.
- 3.10.14 Light Industrial** – This zone provides for light industrial uses and related activities including manufacturing, research, warehouse and distribution, outdoor storage, assembly of non-hazardous products/materials, and retail related to manufacturing. This zone correlates with the Light Industrial General Plan Land Use designation.
- 3.10.15 Mobile Home Parks** - An area under one ownership designed to accommodate the use of factory-constructed residential units containing their own independent sanitary facilities intended for year round occupancy, composed of one or more major components which are mobile in that they can be supported by wheels attached to their own integral frame or structure and towed by an attachment to that frame or structure over the public highway, as well as recreational vehicles such as travel trailers, tent trailers, camping trailers and motorhomes.
- 3.10.16 Multi-family Residential** – A structure composed of attached dwelling units which share any common building components, including, but not limited to, foundations, roofing and structural systems in accordance with City of Perris Zoning Ordinance, Chapter 19.26, such as condo, townhomes, single family court, and apartments.
- 3.10.17 Patio Covers** – Patio covers are one-story structures used for recreational and outdoor living spaces, not as carports, garages, storage rooms, or habitable rooms.
- 3.10.18 Public and Semi-Public Institutions and Facilities** – An institution that is the responsibility of a governmental unit or over which a governmental unit exercises administrative control such as city hall, government offices, community centers or a facility having some features of a public institution such a fraternal lodge or utility.
- 3.10.19 Recreational Uses** – means uses for a pastime, diversion, exercise, or other resource affording relaxation and enjoyment.
- 3.10.20 Residential Care Facilities** – means a facility which provides for the care of more than 12 persons with special needs who reside at the facility. The use of a residential care center shall be considered a non-residential use of property for all zone districts.
- 3.10.21 Restaurant** - means an establishment that serves prepared food as the primary function, with or without the incidental sales of alcoholic beverages served for on-site consumption.
- 3.10.22 Single Family Residential** - A free-standing unattached building for dwelling or residential use by one family unit which does not share any common building components such as foundations, roofing and structural systems, with any other structure or dwelling in accordance with City of Perris Zoning Ordinance, Chapter 19.25.
- 3.10.23 Single Family Court** – is the grouping of residential properties on a development site in order to use the extra land for open space or recreational uses.
- 3.10.24 Skilled Nursing Facility** – An in-patient rehabilitation and medical treatment center staffed with trained medical professionals for short and long-term care.



- 3.10.25 Small Lot Detached Single Family** – A single family residential structure on a lot less than five thousand (5,000) square feet.
- 3.10.26 Solar Farm** – An installation or area of land in which a large number of solar panels are set up in order to generate electricity.
- 3.10.27 Swap Meets (Indoor)** – An indoor gathering for the barter or sale of goods and services.
- 3.10.28 Swap Meets (Outdoor)** – An outdoor gathering for the barter or sale of goods and services.
- 3.10.29 Townhomes** – A townhome is a single-family home that shares one or more walls with other independently-owned units.
- 3.10.30 Urgent Care Facility** – A walk-in clinic focused on the delivery of medical care for minor illnesses and injuries in an ambulatory medical facility outside of a traditional hospital-based or freestanding emergency department.



4  
D  
E  
S  
I  
G  
N  
  
G  
U  
I  
D  
E  
L  
I  
N  
E  
S



## 4 DESIGN GUIDELINES

### 4.1 VISION AND INTRODUCTION

#### 4.1.1 Purpose and Objective

The purpose of the Green Valley Design Guidelines is to work in concert with the Green Valley Specific Plan to guide the planning and design of the neighborhoods within the Green Valley project. The underlying design philosophy is to create a community character and quality that reflects the context of the region. This master planned community emphasizes a variety of residential housing types and reflects the aesthetic charm and neighborhood structure reminiscent of “early 20th century California” towns. By designing to a particular heritage, an architectural tradition for neighborhoods and individual residences shall be established.

These guidelines provide a comprehensive overview of the design criteria and development standards required to implement the desired physical form of the community and its key features. The Guidelines address land use, site design, circulation, landscaping and streetscapes, architectural character, and other components to create a high quality and cohesive community with interconnected open spaces.

While these guidelines establish the quality of architectural and landscape development for the Green Valley project, they are not intended to prevent alternative designs, new technologies, and/or concepts that are compatible with the overall project theme. This document is intended to promote and direct a high level of design quality to the project site while permitting flexibility for creative expression and innovative design solutions.

As a regulatory tool, this guideline document will assist applicants in creating residential neighborhoods and commercial developments that reflect the City’s history, reinforce the sense of community, and utilize sustainable best practices. This document also provides the framework for design review approval of Green Valley’s residential and commercial projects.

Projects must comply with the design principles as stated in the Guidelines. However, the design solutions, schematic drawings, and programming included within this document are intended to illustrate the design intent and are not examples expected to be copied or imitated. There may be other design solutions not shown in the Guidelines that will also result in a successful project.

This document is intended to be used by builders and developers when designing their Master Plot Plans. Any project that is submitted to the Green Valley Design Review Committee and the City of Perris must be reviewed for consistency with these design guidelines. The Green Valley Design Review Committee and the City will review all designs, plans, and construction to ensure compliance with this document and City standards. (Refer to Section 4.4.) The project must then obtain Planning Commission approval under a design review approval process.

#### **Guiding Principles**

The following guiding principles will direct the design of the Green Valley project to ensure quality development:

- Create a community that encourages interaction and evokes a “pride of place” where people want to live.
- Promote linkages and connectivity through land use adjacencies, trails, and open space.
- Create a variety of walkable neighborhoods to further a lifestyle of health, wellness, fitness, activity, and outdoor living in a family-oriented environment.





- Encourage physical, social, and economic diversity.
- Integrate environmentally responsible practices.

These Design Guidelines are interpretational and are, therefore, conceptual in nature. Any changes or deviations from these Design Guidelines can be discussed and negotiated with City staff. As a living document, the Guidelines can, over time, accommodate changes in lifestyles, consumer preferences, economic conditions, community desires, the marketplace, and new technologies.

The architectural and landscape guidelines complement each other. Together they combine to form a distinctive master plan offering a high quality, sustainable environment, and a sense of identity.

## **4.2 RESIDENTIAL ARCHITECTURE**

### **4.2.1 Residential Architectural Guiding Principles**

Within the Green Valley community, the architecture theming is built upon the heritage of the communities of early 20th century California. The early 20th century eclectic and well- composed architecture created rich and complex neighborhood environments.

The master developer is to review and approve all tentative and final tract maps, including an overall Master Tentative Parcel Map, site plans, landscape plans, plant material palettes, architectural plans, and architectural material palettes prior to submittal of plans by the merchant builders to the City of Perris. All projects and future developments, whether or not expressly approved by the master developer, shall conform to the architectural and landscape design standards and guidelines as set forth herein.

The following residential requirements will guide the architecture to ensure quality development:

- All projects and future developments, whether or not expressly approved by master developer, shall conform to the architectural and landscape design standards and guidelines set forth herein.
- Projects shall provide a range of dwelling unit sizes and floor plans consistent with the scale of the project. Standards for dwelling unit sizes and floor plans will be established by the master developer in negotiation with future tract builders, to assure a diversity of product types consistent with the intent of the subject Specific Plan and criteria established in the development standards.
- All recreational areas, recreational improvements, and open spaces within Green Valley are intended for use and enjoyment by the general public. Recreation and open spaces additionally contained within multi-family developments, within attached products, or identified within future tentative tract maps may be for the exclusive use and benefit of those future residents.
- The minimum lot width requirement for single-family dwellings on cul-de-sac bulbs or street knuckles shall be met at the front setback line provided that the minimum width at the right-of-way line is not less than twenty-five (25) feet.
- Provide a varied and interesting streetscene.
- Focus of the home is the front elevation, not the garage.
- Provide a variety of garage placements.
- All residential (multi-family and single family) garages are required to provide sectional garage panels with windows on top garage panel.
- Provide detail on rear elevations where visible from the public streets or open space areas.
- Choose appropriate massing and roof forms to define the architectural styles.
- Ensure that plans and styles provide a degree of individuality.



- Use architectural elements and details to reinforce individual architectural styles.
- All four sides of residential structures (single family and multi-family shall have architectural elements.

#### **4.2.2 General Architectural Guidelines**

##### **1. Single Family Detached**

It is anticipated that several areas of detached single-family residences shall be built in Green Valley. These are intended to be neighborhoods of varying lot size and architectural treatment to minimize marketing overlap.

For single-family developments, the following design criteria shall be applied:

- Local curvilinear arterial and collector street layouts shall be encouraged to enhance the streetscape visual character.
- Use of unbroken or geometric “grid” layouts shall be discouraged.
- Designs shall emphasize the idea of a cohesive community, and therefore, abrupt tract-to-tract transitions shall be avoided.
- Direct interface between Green Valley and adjacent land uses, utilizing buffer zones shall be employed to enhance value and strengthen the community image.
- The construction of single story homes at corner locations shall be encouraged to provide aesthetic visual relief from building mass along the street.
- Garages are required to be setback from the livable portion of the single family home.
- Two-car garages shall be a minimum of 20 feet by 20 feet.
- All residential (multi-family and single family) garages are required to provide sectional garage panels with windows on top garage panel.
- Composition shingles are prohibited.
- All four sides of residential structures (multi-family and single family) shall have architectural elements.

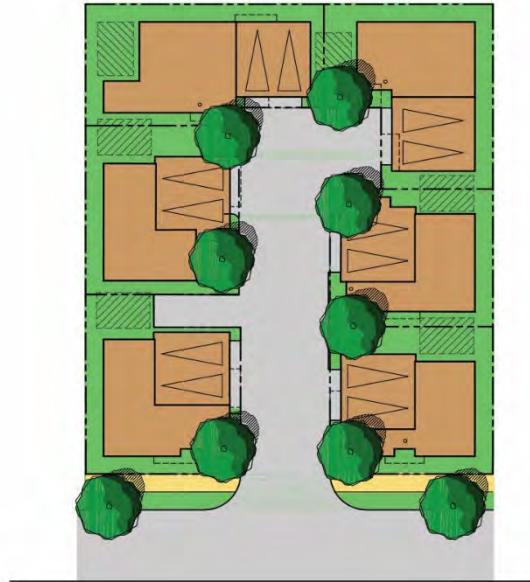
##### **2. Multi-Family**

The Multi-Family designation allows for Single Family Court, Single Family Attached, Apartments, and Condominium dwelling units.

###### **a. Single Family Court/Small Lot Single Family Detached**

Single Family Court homes provide for the privacy of a traditional single family, with less maintenance and a more affordable product. They are typically orientated to a private drive, private alley or a private courtyard. Lots sizes are less than 5,000 square feet.

- Guest parking will be provided along the street or in parking bays.
- Maximum homes on a court will be ten.
- Single Family Court will have the same Architectural style and quality as traditional single family homes.
- Variety in elevations is encouraged within a court or along a street.



TYPICAL LOT DETAIL  
(SINGLE FAMILY COURT)  
N.T.S.

b. Single Family Attached

Includes paired homes and townhomes. Paired homes are two single family home which are attached and townhomes are three or more single family homes which are attached. In any case, you would not have any homes over another home.

- Attached housing and facades shall be articulated to appear as a cluster of individual homes attached rather than one, lone, continuous building.
- Individual buildings should be turned and oriented in a variety of ways to avoid monotony. "Garage door" corridors shall especially be avoided. Buildings shall be articulated in a configuration that adds interest, allows for quality private outdoor areas, and reduces the length of street and utility runs.
- Each unit shall have its own entry and identity. This shall be accomplished by offsetting and staggering each separate unit and by combining one- and two-story building forms to separate massing. This will also provide a varied streetscape.



TYPICAL LOT DETAIL  
(TOWNHOMES)  
N.T.S.

- The maximum number of attached residences shall be 6.
- Attached residences will exhibit the same high quality in construction and design as other housing types. Buildings will be sited to assure compatibility and variety in community-wide building form.
- Attached Single Family project shall have decorative street lighting and street signage.



c. Apartments and Condominiums

The maximum number of stories is three and units may be stacked.

- Maximization of the open space is an important element within a multi-family project. Curving streets and orienting road axes toward open areas and views shall be used to take full advantage of these areas. Open parking areas shall be





treated as landscaped plazas and courts. All landscape areas shall meet the City of Perris landscape requirements.

- Open parking and carports shall be clustered in parking courts and along internal private drives to enhance security. Pedestrian and automobile circulation shall be clearly defined and separated whenever possible. Special paving at parking court entries and landscape nodes between parking stalls shall be encouraged to soften the streetscape.
- Support facilities within multi-family areas such as recreation buildings, laundry facilities, and manager offices shall be consistent in architectural design and form as previously illustrated for the residences. Recreation areas shall be placed in centrally located areas such as project entries or adjacent to the model complex within each complex.
- Multi-family projects shall have decorative street lighting and street signage.
- Rooftop and ground-mounted mechanical equipment shall be located and screened to minimize the visual intrusion of the equipment into the public view. Rooftop equipment may be clustered and shall be painted to match the roof, and shall be located below the ridge of pitched roofs or the parapet of flat roofs. As an alternative for flat roofs, mechanical equipment may be clustered or located behind a screen wall that architecturally complements the building elevation. Such screen walls shall be set back from the building edge at a ratio of two (2) feet horizontal for one (1) foot vertical screen. The screens shall be considered as part of the maximum height limitations.
- Ground-mounted equipment shall be screened from public view with building walls, free-standing solid wall and gates, and overhead trellises complementary with the project's architectural theme. The use of planting in connection with the above architectural elements is required.
- All outdoor storage shall be prohibited with the exception of the trash enclosures and dumpsters. The location and architectural design of trash enclosures shall be unobtrusive in view and use, as well as complementary to the approved architectural style of the development. The enclosure shall be properly maintained and kept free of debris in all areas outside the enclosure. Visual access into any storage areas shall be screened and filtered by concrete with plaster finish or masonry block walls, with solid gates, baffle pedestrian entries, and trellises (if enclosure is within view of second story buildings). The use of shrubs, vines, and trees to screen the overall appearance is encouraged.
- Trash collection areas shall be located where convenient, inconspicuous, and serviceable. Preferred locations are at the far end of a parking bay or the midpoint of a parking area. The trash area should be enclosed and softened with landscaping, trellis work, or other screening techniques. The placement of said trash enclosures shall be such that the service vehicles will not be required to perform a backing maneuver to approach the bins.
- All projects require Development Plan Approval by the City of Perris. Non-subdivision applications may be approved administratively.



TYPICAL LOT DETAIL  
(APARTMENTS)  
N.T.S.

### 3. Edge Conditions

Rear elevations visible from open spaces and major roadways shall incorporate enhanced details used on the front elevation of the home. Rear elevations observable from open spaces and major roadways shall be visually aesthetically pleasing from surrounding viewpoints and adjacencies. Silhouettes and massing of homes along edges require design sensitivity. A row of homes with a single front or rear facing gable are prohibited. The following should be considered, and at least one element incorporated, in the design of the side and rear elevations along edge conditions:

- A balance of hip and gable roof forms;
- Single-story plan;
- Single-story elements on two-story homes;
- Offset massing or wall planes (on individual plans or between plans);
- Roof plane breaks (on individual plans or between plans);
- Detail elements on the front elevation shall be applied to the side and rear elevations along edge conditions.

### 4. Roof Forms

Rows of homes seen along major community roadways are perceived by their contrast against the skyline or background. The dominant impact is the shape of the building and roofline. To minimize the visual impact of repetitious flat planes, similar building silhouettes and similar ridge heights, discernibly different roof plans for each home plan shall be designed. Individual roof plans may be simple but, between different plans, should exhibit variety by using front to rear, side-to-side, gables, hipped roofs, and/or the introduction of single story elements.

The following roof design guidelines should also be considered:

- Provide a mix of gable and hip roofs along the street scene.
- Design roofs for maximum solar exposure for the potential installation of solar features.
- Consider deep overhangs where appropriate to the style to provide additional shade and interior cooling.
- Offset roof planes, eave heights, and ridgelines.
- Composition shingles are prohibited.



#### 5. Corner Buildings

Buildings located on corners often times function as neighborhood entries and highlight the architecture for the overall Green Valley community. Buildings located on corners shall include one of the following:

- Front and side facade articulation using materials that wrap around the corner-side of the building;
- Awning on corner side;
- Home entry on corner side;
  - Corner facing garage;
  - A pop-outside hip, gable, or shed form roof;
  - An added single-story element, such as a wrap-around porch or balcony;
  - Recessed second- or third-story (up to 35' max.); or
  - Balcony on corner side.



#### 6. Front Elevations

Front elevations shall be detailed to achieve a variety along the streetscene. Each front elevation shall incorporate a Feature Window treatment (see Feature Window requirements below). In addition, each front elevation shall incorporate one or more of the following techniques:

- Provide enhanced style-appropriate details on the front elevation.
- Offset the second story from the first level for a portion of the second story.
- Vary the wall plane by providing projections of elements such as bay windows, porches, and similar architectural features.
- Create recessed alcoves and/or bump-out portions of the building.
- Incorporate second-story balconies.
- Create interesting entries that integrate features such as porches, courtyards, large recessed entry alcoves, or projecting covered entries with columns.



Use a minimum of two building materials or colors on the front elevation.

7. Multi-family Entries

Entries for multi-family homes should create an initial impression, locate and frame the doorway, act as a link between public and private spaces, and further identify individual unit entries.



- Wherever possible, orient the front door and principal access towards the roadway, paseo, or common open space.
- Incorporate appropriate roof elements, columns, Feature Windows and/or architectural forms in the entry statement to emphasize the building character and the location of individual doorways.
- If due to building configuration, the front entry location is not immediately apparent, direct and draw the observer to it with added elements such as signs, lighting, and landscape.

8. Feature Windows

All front and visible edge elevations shall incorporate one Feature Window treatment that articulates the elevation. Feature Window options include:

- A window of unique size or shape.
- Picture window.
- A bay window projecting a minimum of 24 inches, or a 12-inch pop-out surround.
- A window with a substantial surround matching or contrasting the primary color of the home.
- A window recess a minimum of 2 inches.
- Decorative iron window grilles.
- Decorative window shelves or sill treatments.
- Grouped or ganged windows with complete trim surrounds or unifying head and/or trim.
- A Juliet balcony with architectural style appropriate materials.
- Window shutters.
- Trellis protruding a minimum of 12 inches from the wall plane of the window.





9. Windows

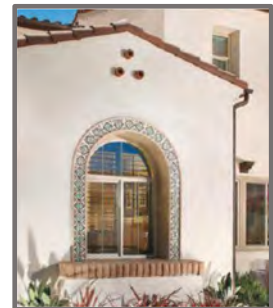
Windows on south-facing exposures should be designed, to the greatest extent possible, to maximize light and heat entering the home in the winter, and to minimize light and heat entering in the summer.

West-facing windows should be shaded where feasible to avoid prolonged sun exposure/overheating of the homes.

For additional window requirements addressing Sound Attenuation requirements refer to the Noise Assessment Report. The city will require a N.A.R. for projects that border major external and internal streets.

10. Garage Door Treatments

Garages must be sectional with garage windows at the top panel. Appropriate treatment of garage doors will further enhance the building elevation and decrease the utilitarian appearance of the garage door. Various garage door patterns, windows, and/or color schemes should be applied as appropriate to individual architectural styles, where feasible.



- Garage doors shall be consistent with the architecture of the building to reduce the overall visual mass of the garage.
- Garage doors shall be recessed 8 inches from the wall plane.
- All garage doors shall be automatic section roll-up doors.
- When appropriate, single garage doors are encouraged.
- Carriage-style garage doors of upgraded design are encouraged.



Street Facing Garages

All street facing garages should vary the garage door appearance along the streetscene. Garages must be sectional with garage windows at the top panel. Below are options for the door variety:

- Vary the garage door pattern, windows, and/or color as appropriate to individual architectural styles.

- Use an attached overhead trellis installed beneath the garage roof fascia and/or above garage door header trim.
- Span the driveway with a gated element or overhead trellis.
- Provide a porte cochere.
- Street facing garages on corner lots at neighborhood entries shall be located on the side of the house furthest away from the corner.



#### 11. Alley Treatments

The use of alleys should be elevated from purely functional, simple garage access to an enjoyable space that residents experience and utilize daily. Design of alleys shall address the functional and aesthetic features of the space to create a positive experience for the residents. At least one of the following shall be implemented along the alley:

- Building size and shape shall have stepped massing (recessed or cantilevered, i.e., stepping back upper floors or protruding forward upper floors) of at least two feet.
- Window trim, color, and appropriate details from the front elevation.
- Rear privacy walls and pedestrian gates designed and located for ease of unit access.
- Enhanced garage door patterns or finishes; garage doors shall complement the design intent of the home and neighborhood.
- Provide sufficient planting areas between garages to soften the vertical architectural planes at alleys.

#### 12. Building Forms

Building form, detail, and placement greatly influences how a structure is perceived based on how light strikes and frames the building. The effect of sunlight is a strong design consideration, as shadow and shade can lend a sense of substance and depth to a building. The following elements and considerations can be used to facilitate the dynamic of light and depth perception of the building.

Architectural Projections

Projections can create shadow and provide strong visual focal points. This can be used to emphasize design features such as entries, major windows, or outdoor spaces. Projections are encouraged on residential building forms. Projections may include, but are not limited to:

- Awnings (wood, metal, cloth)
- Balconies
- Shutters
- Eave overhangs
- Projecting second- or third-story elements
- Window/door surrounds
- Tower elements
- Trellis elements
- Recessed windows
- Porch elements
- Bay windows or dormers
- Shed roof elements



Offset Massing Forms

Front and street-facing elevations may have offset masses or wall planes (vertically or horizontally) to help break up the overall mass of a building.

Offset forms are effective in creating a transition:

- Vertically between stories, or
- Horizontally between spaces, such as recessed entries.
- Offset massing features are appropriate for changes in materials and colors.
- Offsets should be incorporated as a functional element or detail enhancement.
- Over-complicated streetscenes and elevations should be avoided.
- Streetscenes should provide a mix of simple massing elevation with offset massing elements to compose an aesthetic and understandable streetscape.



Floor Plan Plotting

In each single-family detached neighborhood with 65 homes or more, provide:

- Six floor plans.
- Four elevations for each floor plan using a minimum of three architectural styles. If only two styles are selected, elevations shall be significantly different in appearance.
- Four different color schemes for each floor plan.

In each single-family detached neighborhood with 65 homes or less, provide:

- Three floor plans.



- Three elevations for each floor plan using a minimum of three architectural styles. If only three styles per floor plan are selected, elevations shall be significantly different in appearance.
- Four different color schemes for each floor plan.

In each single-family detached neighborhood, street facing garages on corner lots at neighborhood entries shall be located on the side of the house furthest away from entry corner.

#### Style Plotting

To ensure that architectural variety occurs, similar elevations cannot be plotted adjacent to or immediately across the street from one another. No more than two of the same floor plan/elevations shall be plotted next to each other or directly across the street from one another. The following describes the minimum criteria for style plotting:

- For a home on a selected lot, the same floor plan and elevation is not permitted on the lot most directly across from it and the one lot on either side of it.
- Identical floor plans may be plotted on adjacent lots, provided a different elevation style is selected for each floor plan.
- Identical floor plans may be plotted on lots across the street from each other provided a different elevation style is selected for each floor plan.

#### Color Criteria

To ensure variety of color schemes, like color schemes cannot be plotted adjacent to or immediately across the street from one another. Color and material sample boards shall be submitted for review along with the Master Plot Plan. (Refer to Section 4.4.)

A color scheme for a home on a selected lot may not be repeated (even if on a different floor plan) on the three lots most directly across from it and on the single lot to each side of it.

Extensively bold, bright, fluorescent, and neon colors are prohibited. If used, bold, bright, fluorescent, and neon colors should only be used as accent colors on window and door frames, building trim, and details.



Lower Height Elements

Lower height elements are important to streetscene variety, especially for larger buildings or masses, as they articulate massing to avoid monotonous single planes. These elements also provide a transition from the higher story vertical planes to the horizontal planes of sidewalk and street, and help to transition between public and private spaces. Lower height elements are encouraged to establish pedestrian scale and add variety to the streetscene. Lower height elements may include, but are not limited to:

- Porches
- Entry features
- Interior living spaces
- Courtyards
- Bay windows
- Trellises



Balconies

Balconies break up large wall planes, offset floors, create visual interest to the facade, provide outdoor living opportunities, and adds human scale to a building. Scaled second- or third-story balconies can have as much impact on stepped massing and building articulation as a front porch or lower height elements. Balcony elements:

- May be covered or open, recessed into or projecting from the building mass.
- Shall be an integral element of, and in scale with, the building mass, where appropriate.
- Are discouraged from being plotted side-by-side at the same massing level (i.e., mirrored second-story balconies).



Roof Considerations

Composition and balance of roof forms are as definitive of a streetscape as the street trees, active architecture, or architectural character.

- Rooflines and pitches, ridgelines and ridge heights should create a balanced form to the architecture and elevation.
- Direction of ridgelines and/or ridge heights should vary along a streetscene.
- Roof overhangs (eaves and rakes) may be used as projections to define design vocabulary, create light, and shade patterns.
- Hip, gable, shed, and conical roof forms may be used separately or together on the same roof or streetscene composition.
- Roof form and pitch shall be appropriate to the massing and design vocabulary of the home.



**13. Outdoor Living Spaces**

Outdoor living spaces, including porches, balconies, and courtyards, activate the streetscene and promote interaction among neighbors. Outdoor living spaces can also create indoor/outdoor environments opening up the home to enhance indoor environmental quality. Wherever possible, outdoor living space is encouraged.



**14. Materials**

The selection and use of materials have an important impact on the character of each neighborhood and the community as a whole. Wood is a natural material reflective of many architectural styles; however, maintenance concerns, a design for long-term architectural quality and new high-quality manufactured alternative wood materials make the use of real wood elements less desirable. Where “wood” is referred to in these guidelines, it can also be interpreted as simulated wood trim with style-appropriate wood texture. Additionally, some styles can be appropriately expressed without the wood elements, in which case stucco-wrapped, high-density foam trim (with style-appropriate stucco finish) is acceptable. Precast elements can also be satisfied by high-density foam or other similar materials in a style-appropriate finish.

- Brick, wood, and stone cladding shall appear as structural materials, not as applied veneers.
- Material changes should occur at logical break points.
- Columns, tower elements, and pilasters should be wrapped in its entirety.
- Materials and colors should be varied to add texture and depth to the overall character of the neighborhood.
- The use of flashy or non-traditional materials or colors that will not integrate with the overall character of the community is prohibited.
- Material breaks at garage corners shall have a return dimension equal to or greater than the width of the materials on the garage plane elevation.
- Use durable roofing and siding materials to reduce the need for replacement.
- Use local, recycled and/or rapidly renewable materials to conserve resources and reduce energy consumption associated with the manufacturing and transport of the materials. (Refer to Section 4.4 for Design Review process.)

**15. Exterior Structures**

Exterior structures, including but not limited to, porches, patio covers, and trellises shall reflect the character, color, and materials of the building to which they are related.

- Columns and posts should project a substantial and durable image.

- Stairs should be compatible in type and material to the deck and landing.
- Railings shall be appropriately scaled, consistent with the design vernacular of the building, and constructed of durable materials.
- Exposed gutters and downspouts shall be colored to complement or match the fascia material or surface to which they are attached.



#### 16. Accessory Structures

Accessory structures should conform to the design standards, setbacks, and height requirements of the primary structure. If visible from the front or side lot line, the visible elevation should be considered a front elevation and should meet the design criteria of the applicable architectural style.

#### 17. Lighting

Appropriate lighting is essential in creating a welcoming evening atmosphere for the Green Valley community. As a forward-thinking community, The Green Valley development will institute dark sky recommendations to mitigate light pollution, cut energy waste, and protect wildlife. All lighting shall be aesthetically pleasing and non-obtrusive, and meet the dark sky recommendations.

Lighting shall meet the following guidelines:

- All exterior light fixtures and fixture placement shall comply to the standards specified in the City’s design documents. Use of LED technology where possible and feasible is recommended.
- Streets and intersections should be well lighted in accordance with the City standard illumination levels. Low-level lighting for pedestrian safety should be installed where appropriate. Intersections should have increased light levels for definition and to mitigate automobile/pedestrian conflicts.
- Accent lights should be installed at all primary entry monuments, secondary monuments, and park/ trail monuments.
- Streetlights shall conform to the overall project theme and city standards.
- All exterior lighting for identification, pools, water features, and landscaping should be subdued and indirect to prevent spill over onto adjacent lots and streets.
- The type and location of building lighting should preclude direct glare onto adjacent property, streets and skyward by the use and application of shields
- Pedestrian scale fixtures are encouraged over “high mast” poles.
- Consistent lighting fixtures shall be used throughout the Green Valley development to enhance community character.
- Light rays shall be confined on-site through orientation, the use of shading/directional controls, and/or landscape treatment.
- Minimum illumination requirements are one-foot candle across parking areas and sidewalks.

- Each residence shall have an exterior porch light at its entry that complements the architectural style of the building.
- Where feasible, lighting should be on a photocell or timer.



Lighting within development areas adjacent to Open Space Districts shall comply with the following “dark sky” lighting regulations:

1. Flood lamp shielding and/or City-approved “dark sky” light fixtures/bulbs shall be used in developed areas to reduce the amount of stray lighting into natural resource areas.
2. Direct lighting rays shall be confined to the respective residential, resort, commercial, or common area lots upon which the exterior lights are to be installed so that adjacent Open Space Districts are protected from any significant light spillage, intrusion, and glare.
3. No skyward casting lighting shall be allowed in development areas adjacent to Open Space Districts
4. Address Numbers - To ensure public safety and ease of identifying residences by the Fire and Police Departments, address numbers shall be lighted internally and easily visible from the street.





#### 4.2.3 Residential Architectural Styles

Green Valley is envisioned as a sustainable, contemporary community where architectural massing, roof forms, detailing, walls, and landscape collaborate to reflect historic, regional, and climate-appropriate styles.

The design criteria established in this section encourages a minimum quality design and a level of style with appropriate elements. Although the details are important elements that convey the style, the massing and roof forms are essential to establishing a recognizable style. The appropriate scale and proportion of architectural elements and the proper choice of details are all factors in achieving the architectural style.

##### **Architectural Theme**

The styles selected for Green Valley have been built upon the heritage of the communities of early 20th century California, a majority of which have been influenced by the Spanish Mission and Mexican Rancho eras. Over the years, architectural styles in California became reinterpreted traditional styles that reflect the indoor-outdoor lifestyle choices available in the Mediterranean climate. These styles included the addition of western materials while retaining the decorative detailing of exposed woodwork, wrought iron hardware, and shaped stucco of the original Spanish styles. Mixing of style attributes occurs in both directions, such as adapting Spanish detailing to colonial style form, or introducing colonial materials and details to the Hacienda form and function. The landscape and climate of California have also generated styles that acknowledge and blend with its unique setting.

The following styles can be used within Green Valley:

- Spanish Colonial
- Monterey
- Craftsman
- California Wine Country
- California Prairie

Additional architectural styles compatible with the intent of these guidelines may be added when it can be demonstrated that they are regionally appropriate.

The following pages provide images and individual “style elements” that best illustrate and describe the key elements of each style. They are not all mandatory elements, nor are they a comprehensive list of possibilities. The degree of detailing and/or finish expressed in these guidelines should be relative to the size and type of building upon which they are applied.

These images in the pages that follow are for concept and inspiration only and should not be exactly replicated.

**1. Spanish Colonial**

This style evolved in California and the southwest as an adaptation of Mission Revival infused with additional elements and details from Latin America. The style attained widespread popularity after its use in the Panama-California Exposition of 1915.

Key features of this style were adapted to the California lifestyle. Plans were informally organized around a courtyard with the front elevation very simply articulated and detailed. The charm of this style lies in the directness, adaptability, and contrasts of materials and textures. Figure 4-1 depicts examples of Spanish Colonial architectural styles.

**Spanish Colonial Style Elements:**

- Plan form is typically rectangular or “L”- shaped.
- Roofs are typically of shallower pitch with “S” or barrel tiles and typical overhangs.
- Roof forms are typically comprised of a main front-to-back gable with front-facing gables.
- Wall materials are typically stucco.
- Decorative “wood” beams or trim or typical.
- Segmented or full-arch elements are typical in conjunction with windows, entry, or the porch.
- Round or half-round tile profiles are typical at front-facing gable ends.
- Arcades are sometimes utilized.
- Windows may be recessed, have projecting head or sill trim, or be flanked by plank-style shutters.
- Decorative wrought-iron accents, grille work, post or balcony railing may be used.





FIGURE 4-1

**Example of Spanish Colonial Architectural Style**



**Example of Spanish Colonial Architectural Style**

Not to Scale





**2. Monterey**

The Monterey style is a combination of the original Spanish Colonial adobe construction methods with the basic two-story New England colonial house. Prior to this innovation in Monterey, all Spanish colonial houses were of single story construction.

First built in Monterey by Thomas Larkin in 1835, this style introduced two story residential construction and shingle roofs to California. This Monterey style and its single story counterpart eventually had a major influence on the development of modern architecture in the 1930’s.

The style was popularized by the used of simple building forms. Roofs featured gables or hips with broad overhangs, often with exposed rafter tails. Shutters, balconies, verandas, and porches are integral to the Monterey character. Traditionally, the first and second stories had distinctly different cladding material; respectively siding above with stucco and brick veneer base below.

The introduction of siding and manufactured materials to the home building scene allowed for the evolution of the Monterey home from strictly Spanish Adobe construction to a hybrid of local form and contemporary materials. Siding, steeper pitched flat tile roofing, and the cantilevered balcony elements on the Monterey house define this native California style. Figure 4-2 depicts examples of Monterey architectural styles.

Monterey Style Elements:

- Plan form is typically a simple two-story box.
- Roofs are typically shallow to moderately pitched with flat concrete tile or equal; “S” tile or barrel tile are also appropriate.
- Roof forms are typically a front-to-back gable with typical overhangs.
- Wall materials are typically comprised of stucco, brick, or siding.
- Materials may contrast between first and second floors.
- A prominent second-story cantilevered balcony is typically the main feature of the elevation; two-story balconies with simple posts are also appropriate.
- Simple Colonial corbels and beams typically detail roof overhangs and cantilevers.
- Balcony or porch is typically detailed by simple columns without cap or base trim.
- Front entry is typically traditionally pedimented by a surround, porch, or portico.
- Windows are typically accented with window head or sill trim of colonial-style and louvered shutters.
- Corbel and post sometimes lean toward more “rustic” details and sometimes toward more “Colonial” details.







FIGURE 4-2



Example of Monterey Architectural Style



Example of Monterey Architectural Style

Not to Scale



3. Craftsman

Influenced by the English Arts and Crafts movement of the late 19th century and stylized by California architects like Bernard Maybeck in Berkeley and the Greene brothers in Pasadena, the style focused on exterior elements with tasteful and artful attention. Originating in California, Craftsman architecture relied on the simple house tradition, combining hip and gable roof forms with wide, livable porches, and broad overhanging eaves. The style was quickly spread across the state and across the country by pattern books, mail-order catalogs, and popular magazines.

Extensive built-in elements define this style, treating details such as windows and porches as if they were furniture. The horizontal nature is emphasized by exposed rafter tails and knee braces below broad overhanging eaves constructed in rustic-textured building materials. The overall effect was the creation of a natural, warm, and livable home of artful and expressive character. Substantial, tapered porch columns with stone piers lend a Greene character, while simpler double posts on square brick piers and larger knee braces indicate a direct Craftsman reference to the style of California architect Bernard Maybeck, who was greatly influenced by the English Arts and Crafts Movement of the late 19th Century. Figure 4-3 depicts examples of Craftsman architectural styles.

Craftsman Style Elements:

- .
- Roofs are typically of shallower pitch with flat concrete tile or equal, and exaggerated eaves.
- Roof forms are typically a side-to-side gable with cross gables.
- Roof pitch ranges from 3:12 to 5:12 typically with flat concrete tile or equal.
- Wall materials may include stucco, horizontal or shingle siding, and stone.
- Siding accents at gable ends are typical.
- A front porch typically shelters the main entry.
- Exposed rafter tails are common under eaves.
- Porch column options are typical of the Craftsman style.
- Windows are typically fully trimmed.
- Window accents commonly include dormers or ganged windows with continuous head or sill trim.







**Example of Craftsman Architectural Style**



**FIGURE 4-3**

**A  
R  
C  
H  
I  
T  
E  
C  
T  
U  
R  
A  
L  
  
S  
T  
Y  
L  
E**



**Example of Craftsman Architectural Style**

Not to Scale



**4. California Wine Country**

California Wine Country architecture is typically a simple structure that takes advantage of 360-degree views while staying true to the nature of the land. This rustic and sophisticated style is appreciative of the surrounding topography and softens the lines between indoor and outdoor living. The California Wine Country style is diverse and borrows details from Tuscan and European architecture and reworks them into something that is particularly California. This casual and sophisticated style incorporates the agricultural vernacular into the structure and creates a form that is luxurious yet approachable. Figure 4-4 depicts examples of California Wine Country architectural examples.

**California Wine Country Style Elements:**

- Simple rectangular form may be layered to create casual massing, often asymmetrical.
- Low-pitched gabled primary roofs (3:12 to 5:12) are common.
- Shed porches are typical.
- Roofs are typically barrel tile or “S”-tile.
- Exposed rafter tails enhance an elevation.
- Stucco can be the primary wall material, but over grouted stone or brick is also common.
- Windows with head and sill trim or full surrounds are typical.
- Rustic column posts and wood railings are typical.
- A massive chimney (battered or tapered) clad in stucco, stone, or brick is common.
- Wood trellises, shutters, and/or applied sheds over windows are typical details.







FIGURE 4-4



**Example of California Wine Country Architectural Style**



**Example of California Wine Country Architectural Style**

Not to Scale



**5. California Prairie**

The Prairie style, generated by the Chicago Prairie School movement, is organic in nature and integrated with the land, and uses natural materials and abstracted natural forms. Its strong horizontal lines, low-pitched roof with large overhanging eaves, and windows assembled in horizontal bands are indicative of this style. The Prairie style is also known for incorporating open floor plans within the home. The California Prairie style will add a strong horizontal aspect within Green Valley. Figure 4-5 depicts examples of California Prairie architectural styles.

**California Prairie Style Elements:**

- Form is one or two-story with strong horizontal massing.
- Secondary masses are perpendicular to the primary forms.
- Roofs are long horizontal low-pitched hip roofs with large overhanging eaves that emphasize the horizontal planes.
- Roof overhangs are 36" minimum.
- Roof pitch ranges from 3.5:12 to 4:12 typically with flat concrete tile or equal.
- Stucco walls with ledge stone or masonry is typical.
- Extensive use of ledge stone or brick to emphasize the horizontal planes is indicative of the Prairie style.
- Square or rectangular windows with wood trim may be grouped to emphasize the geometry of the building form.
- Ribbons of windows arranged in horizontal bands is common.
- Massive chimney forms wrapped in stone or brick is an enhanced detail of this style.
- Terraces covered by the primary roof form with large rectilinear stone piers for roof support is typical.





GREEN VALLEY



FIGURE 4-5



Example of California Prairie Architectural Style



Example of California Prairie Architectural Style

Not to Scale



### 4.3 COMMERCIAL, BUSINESS AND PROFESSIONAL, AND LIGHT INDUSTRIAL GUIDELINES

This section intends to provide general design guidance for the Commercial, Business and Professional, and Light Industrial uses at Green Valley. The guidelines are intended to:

- Define the quality and character of non- residential uses.
- Promote the pedestrian and human scale to ensure compatibility between non- residential and residential uses.
- Minimize negative impacts to adjoining uses through the use of setbacks and/or landscaping.
- Enhance the pedestrian environment and strengthen overall community connectivity.
- Lessen potential negative visual impacts from the scale, bulk, and mass inherent in large non-residential buildings.
- Promote site building and landscape design that are consistent with Green Valley’s commitment to sustainability (see section 1.5.4).



#### 4.3.1 Site Planning

The following site planning elements advance aesthetic quality, efficient use of the land, public safety, and environmental responsibility.

##### Connectivity

The non-residential planning areas should be designed to allow for the safe and convenient movement of pedestrians, bicycles, and vehicles:

- Provide clearly delineated pedestrian paths from perimeter sidewalks or trails to the building’s primary entrance.
- Encourage individual parcels to make internal connections to adjoining mixed-use parcels to inspire walking instead of driving to the same destination.
- Locate accessible bicycle parking near the building’s main entrance.

##### Building Placement/Orientation

Special attention should be paid to the impacts of visibility, massing, and the height of the building. The following elements should be considered during site design:

- Orient buildings to establish positive relationships with the adjacent streets.
- Use building location to frame and enclose interesting outdoor gathering spaces.
- Face primary entrances to off-street parking areas.



- Screen service and loading areas from the street where feasible.
- Make building entrances clearly visible and easily identifiable as visitors access the site.
- Provide well-defined pedestrian connections from the parking areas to the building entrances.

Site Amenities/Public Gathering Spaces

Public gathering spaces are encouraged to promote a vibrant and interactive environment for residents, employees, and visitors. Common use areas may include, but are not limited to: plazas, al fresco dining areas, building entry forecourts, and courtyards. These places provide opportunities for activities such as casual meetings, outdoor eating, and small group gatherings.

- Locate buildings to create and enclose a mix of outdoor people gathering spaces.
- Exterior design of buildings shall accommodate signage for future tenants.
- All signage shall conform to the City of Perris sign ordinance.
- Design public gathering spaces large enough to be usable, but not so large as to appear empty or inhospitable.
- Accommodate solar orientation for public gathering spaces to allow sunny outdoor spaces in winter and shade in the summer.
- Furnish public gathering spaces with appropriate site amenities such as benches, low walls, shade trees, shade structures, water elements, and bollards to facilitate pedestrian uses.
- Activate the pedestrian environment by interactive architecture and landscape including:
  - Architecturally vibrant storefronts
  - Benches and planter walls for seating opportunities
  - Water features, murals, or public art
  - Accent or festive lighting to enhance nighttime ambiance



Access and Site Circulation

Driveway access to parcels should provide safe vehicular movement and prevent traffic congestion as follows:

Design driveways and parking areas to provide sufficient vehicular stacking during peak usage.

- Provide a setback of fifty feet from the street curb to the first parking stall perpendicular to a driveway or to the first drive aisle intersection.
- All drive-throughs shall have a minimum 8-car stacking capability.
- Service entries and loading docks shall be placed towards the rear and non-public view sides of buildings.





Parking

Visitor and employee parking shall be provided pursuant to the requirements of P.M.C 19.69 (Parking and Loading Standards). Individual developments, however, are encouraged to seek opportunities, incorporate design features, or utilize transportation management strategies that include shared parking to reduce automobile use.

- Provide convenient locations for handicap, carpool, and bicycle parking.
- Screen parking areas from view of public streets through the use of plant material, low walls, and/or berms.
- Reduce the heat island effect by providing shade canopies and shade trees.

Utilities, Services, and Trash Collection

Utilities, services, and loading areas should be provided on each non-residential development to service the business and activities conducted on the parcel.



- Locate above-ground utility features so they are not highly visible from the street or pedestrian routes.
- All utilities shall be placed underground, including existing lines along Murrieta Road. Placement of underground utilities shall not interfere with landscape planting.
- Cluster the utility infrastructure where feasible, and screen with landscape materials, berms, walls, and/or other architectural features.
- Screen utility cabinets and pedestals within parking lot landscape islands or parkways.
- Screen service and loading areas from the street where feasible.
- Screen all rooftop equipment and communication equipment from abutting roadways by parapet walls or roof structures.



- Locate service and refuse collection areas within interior, side, or rear yards oriented away from public view.
- Screen service loading areas and refuse enclosures by a solid wall with materials of appropriate color and texture compatible to the adjoining building. Soften with landscape foundation planting.
- Trash enclosures shall include an overhead trellis for screening and shade. The wall of the trash enclosure shall include stucco (to match building), slumpstone or split-face material. The Trash enclosures shall have a metal mesh or other material between the split-face block wall and overhead trellis.

#### **4.3.2 Commercial Architectural Guidelines**

Commercial areas are to be visually attractive and cohesive with the surrounding residential and natural environment. The successful creation of pedestrian-friendly, non-intrusive development within Green Valley can be achieved by applying the following:

- Present a unified development character without creating repetitious or redundant forms or design.
- Buildings shall be scaled appropriately and shall be genuine to the location and use of the building.
- Buildings shall be complementary to the design vocabulary of Green Valley.



##### **1. Building Form**

Building placement, form, and detail should complement each other to create an aesthetically interesting streetscape practical for pedestrians and business activity. The following design elements should be considered:

- Provide well-proportioned building forms that result in a balanced composition of elements.
- Modify and vary building masses between adjacent buildings.
- Layer wall planes and volumes to provide a rhythm of dynamic building forms and shadows.
- Provide building massing that consist of a mix of heights, both within and between buildings.

##### **2. Roof Considerations**

Roofs should be designed for functionality and complement/elevate the overall architectural design of the building. The following design elements should be considered:

- Encourage vertical roof plane breaks, changes in building/ridge height or other accent roof forms.
- Integrate materials and form with the overall design vernacular of the development.
- Utilize fascia and/or cornice elements that are consistent with the primary design.
- When used, parapets should be contiguous and incorporate side/rear elevation returns to eliminate false fronts or unfinished appearances.



**3. Facade Treatments**

Buildings should have articulation along auto and pedestrian corridors to generate pedestrian scaling and visual interest along the streetscape.

- Avoid blank walls, especially along the primary pedestrian walkway and street frontages.
- Detail buildings that use only one building material with banding, architectural details, textures, color variation, and/or offset massing.
- Unify architectural design for all pedestrian or major roadway elevations.
- Provide shadow articulation and scale to building elevation through overhangs, projections, and recesses.



**4.3.3 Commercial / Mixed- Use Design Criteria**

The daily needs of residents and visitors of Green Valley and business employees may be met in well-designed commercial retail development. These commercial retail spaces shall be of a pedestrian-scale and may include such diverse businesses like pharmacies, food services, independent businesses or offices, financial services, florists, or personal services. Accessibility, pedestrian scale, and site/ building design are of great importance to the success and suitability of the commercial developments.

- Where practical and reasonable, buildings should appear as a collection of smaller individual buildings rather than a single uninterrupted large building, including:
  - Building forms that appear to be on a tenant-by-tenant basis, having mixed either facade treatments or facades with unified design, materials, and color palettes with a varied massing.
  - Varied massing with unified design, materials, and color palettes.
  - Articulate building/tenant entries.
  - Provide glazing on elevation with tenant/visitor entries.
  - Incorporate pedestrian-scale windows, architectural features, and massing.







- Rear elevations, when visible to adjacent residential development or where fronting major roadways, should be articulated.

#### **4.3.4 Lot Coverage Guidelines**

##### **1. Scale**

Scale refers to the massing and form of a building and includes elements such as building height and footprint. Depending on how a building is designed, it can either positively or negatively affect the character of a neighborhood and quality of the streetscape experience.

The guidelines that follow provide for the ability to create an inviting environment that considers the pedestrian and motorist experience throughout the neighborhood as it relates to visual interest and comfort in a space.

##### **2. Massing and Building Form**

- In general, building form and mass shall derive from the building footprint and will be compatible with the overall neighborhood context.
- In general, building form shall allow for the creation of multiple usable zones that offer private and public spaces for residents.
- Maximum height limits of buildings will help maintain an appropriate human scale relationship that assists in making the public realm more pedestrian friendly.
- To create interest along the streetscape, building massing shall be variegated through the staggering of horizontal and vertical planes. To this end, no building wall shall extend more than 25' vertically or horizontally with a visual break created by a 2' minimum offset or architectural detail.
- Maximum building heights shall be pursuant to Chapter 3, Specific Plan Zoning.

#### **4.3.5 Business and Professional Architectural Guidelines**

##### **1. Access and Circulation**

- Enhanced paving should be used on internal walkways providing connections between entries and public rights of way.
- Pedestrian walkways should be embellished and defined by landscaping, trees, lighting, and textured paving.
- Pedestrian walkways through parking lots should be accented with special design features such as raised, colored and/or textured pavement, a widened roadway, or a combination of the former.

##### **2. Plaza Elements**

Enhanced visitor area(s) (i.e., a plaza, patio, courtyard, linear promenade, terrace, or usable landscaped area) should be scaled accordingly to the size and demands of the particular user or facility and that exhibit a higher level of design treatments by incorporating seating, sculpture, trash receptacles, ash urns, pedestrian scaled lighting enhancements and other furnishings as appropriate for the specific user. Plazas and open space areas provide both a friendly and inviting vision and environment by incorporating some of the following elements:

- Architectural features and furnishings adhering to a consistent theme.
- Seating, such as benches, tables and chairs, and/or low seating walls.



- Enhanced paving using a combination of textures and patterns, site walls including tree grates.
- Decorative light fixtures. Pedestrian scale, bollard, or other accent lighting.
- Landscaping of special interest, landscape buffering, screen walls, trellises, pergola structures and large scale canopy trees.
- Public art or other focal point amenity.
- Water feature
- Covered outdoor eating area to include benches, tables and chairs.

Plazas should be oriented toward the public view whenever possible. Special opportunities for plazas adjacent to building entrances, in food service areas, or between building clusters should be provided.

**4.3.6 Light Industrial Architectural Guidelines** The Light Industrial Planning Areas are within the Western Riverside County Multiple Species Habitat Conservation Plan (MSHCP) Criteria Cell and are not yet approved nor entitled for the land uses identified from the original Green Valley Specific Plan. These Planning Areas require a consistency determination with the MSHCP as part of the entitlements process.

1. Industrial operations should be screened from the public view and oriented away from residential uses, according to required setbacks with live plant material including, but not limited to, trees, shrubs and ground cover. All landscaped areas shall be provided with permanent, automatic irrigation facilities. All landscaping plans shall be prepared by a registered landscape architect.
2. Truck driveways should be separated from passenger traffic to the greatest extent possible and provide for 50-foot turning radii.
3. Truck drive aisles shall be a minimum 40 feet wide.
4. Outdoor display area of products covering less than 5% of the lot area is allowed upon approval of a Minor Development Plan Review by the Planning Department pursuant to Chapter 19.54. Outdoor display area of products covering more than 5% of the lot area is allowed upon approval of a Conditional Use Permit.
5. An outdoor break area should be provided at each office area location. It should include an eating area (tables and seating) covered by overhangs, patio covers, pergolas, etc. This area should be designed to create a sense of privacy and separation through the use of enhanced landscaping and paving, as well as landscape screening/low garden walls or combination thereof.

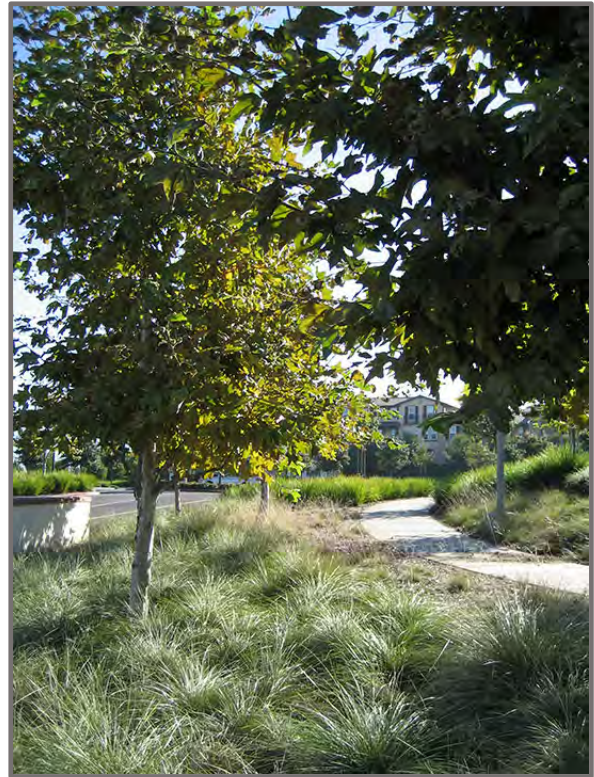
**4.4 LANDSCAPE PLAN**

**4.4.1 Landscape Design Guiding Principles**

***Sustainable Landscape Design***

Through thoughtful, sensitive design, Green Valley can be developed to conserve valuable resources and create a noteworthy community within the City of Perris. Sustainable landscape design links natural and built systems to achieve balanced environmental, social, and economic outcomes and improves quality of life, and the long-term health of communities and the environment. Sustainable landscape balance the needs of people and the environment and benefit both. Landscape Architects are encouraged to research alternative possibilities and incorporate them into the Model Home and community common area landscape design. The following is a list of various ‘sustainable’ features and practices to be used and/or considered for the Green Valley Development at the improvement plan phase/ level.

- Incorporate a water management system utilizing up-to-date best management practices that allows groundwater to recharge.
- Encourage the use of low toxic wood preservatives (no CCA), or naturally rot-resistant wood for landscaping.
- Due to drought situations, be mindful to choose low water, drought tolerant, and/or native plants that match the microclimate, and soil conditions. (Refer to Plant Matrix herein)
- Select plants that are “non-invasive” according to the current California Invasive Plant
- Inventory, published by the California Invasive Plant Council.
- Design landscape and plant spacing to allow for plants to reach mature size. Using appropriate sizes and the thoughtful placing of plants prevents overgrowth and future thinning, reducing the amount of material sent to the landfill.
- Locate plants to ensure proper drainage and to reduce potential damage to buildings.
- Reuse soils from the site, if appropriate, as horticultural soils.





- Maintain and/or improve soil health through responsible management including nurturing soil with organic matter, reducing synthetic fertilizer use, and restoration to sustain protected and future ecosystems.
- Use integrated pest management to control or eliminate pesticide and toxic chemical use.
- Create and/or maintain wildlife habitat.
- Increase tree cover to provide shade in developed areas to reduce energy demand, mitigate solar heat gain into buildings, and to reduce the amount of heat absorbed by paved areas.
- Plant deciduous trees on the south side of buildings to allow for increased solar heat gain in winter months (thereby reducing energy needed for heating interiors) and shading in summer months (thereby reducing energy needed for cooling interiors).
- The use of turf within common area landscape and front yards is prohibited and is respectful of the AB1881 Water Use Analysis. Turf will be permitted only within Active Park Areas. Single-family residential front yards and neighborhood parkways shall be turf-free zones.
- Utilize weather and climate-smart irrigation controllers.
- Design irrigation zones to suit plant requirements and incorporate high-efficiency nozzles.
- Use sustainable materials in landscape construction and site furnishing selections including, but not limited to, recycled materials, environmentally preferable/ responsible products, materials that can be recycled, certified “green” products, and locally available or locally manufactured products.
- Use nitrogen-fixing plants to reduce fertilizer use.
- Create natural looking designs to reduce maintenance required.
- Incorporate water conservation measures (xeriscape, rain gardens, grouping plants with similar requirements).
- Control water runoff (bioswales, rain gardens, green roofs).
- Shrub placement in medians shall be designed to form natural groupings with varying heights to create a multi-tiered effect that will not require excessive pruning or hedging.
- No turf shall be used within medians.
- Shrubs within medians shall not exceed 36 inches in height. Within 50 feet of the end of the median, plant materials shall not exceed 24 inches in height.
- Irrigation systems shall be compliant with current the AB 1881 Model Water Efficiency Landscape Ordinance and any current water efficiency measures.
- Natural clustering of tree species is encouraged.

In addition to incorporating the measures listed above, all landscape improvements shall comply will the City of Perris’ Landscape Design Guidelines, Section 19.70.060 of the Perris Zoning Code. Additional requirements may be deemed appropriate by the City of Perris’ Director of Development Services.



#### 4.4.2 Community Design Theme/ Landscape Character

Landscaping plays an important role in establishing the visual identity and character of the Green Valley community. Consistency in theme and the application of major community-level design elements, such as enhanced entry with dynamic monumentation, upgraded hardscape and master landscape, arterial street parkways, thoughtful specifications of walls, fences and pilasters, adjacent community interface with improved edge conditions, and site-specific plant materials, is designed to be maintained throughout the Green Valley development to communicate and enhance the community's identity.

Green Valley embraces the Early California Heritage theme. Careful thought has been given to integrate the structural and aesthetic elements of a balanced, cohesive community. To ensure that these design guidelines are implemented in a manner that will provide a sense of the City of Perris' character and ambiance, a central theme embracing Early California Heritage has been developed. This theme is appropriate to the community's locale and history, and is sympathetic to the current drought California is facing. It will tie the community together while enabling neighborhoods and mixed-use areas to further develop their individual character through their own unique elements.

Several identifying design and landscape elements will be incorporated throughout the community and will generally include:

- Timeless stone, poured-in-place or pre-cast concrete, and wood beams are incorporated into monumentation, way-finding, and accessory structures.
- Natural landscaped areas blended with manicured landscaping.
- Low water, drought-tolerant and native tree and shrub materials.
- Natural materials such as stone, wood, and boulders, complemented by an earth-tone color palette.
- Varied paving materials, including stone, concrete, wood, decomposed granite, and concrete pavers.



Green Valley is a planned community that is inspired by the rural style of Perris and recognizes the historical character of the Perris Valley. Like California itself, the design intent and architecture is an eclectic and colorful mix of various influences from across the United States. This community offers its residents an environment in which pedestrian connectivity, recreational activity, and social interaction are fostered. The residential neighborhoods within Green Valley focus on these aspects by providing residences oriented to the street, widened pathways/trails throughout the development, public gathering areas, and several community parks with recreational amenities.



Thematic elements are major project improvements that occur at the community or neighborhood level, and assist in establishing the overall design theme for the Green Valley community. These major thematic elements will be reinforced within the following:

- Monumentation/ Signage
- Streetscape Landscape
- Enhanced Masonry Vertical Elements
- Enhanced Hardscape
- Enhanced Community Edge Conditions
- Open Space, Parks and Recreation Facilities
- Lighting/ Street Furniture Family
- Walls and Fences
- Landscaping/Plant Palette

These thematic elements will commonly occur throughout the community and will Green Valley under a common design vocabulary. General design guidelines and design criteria for the community theme elements are contained in the sections that follow. Figure 4-6 illustrates the Landscape Plan.

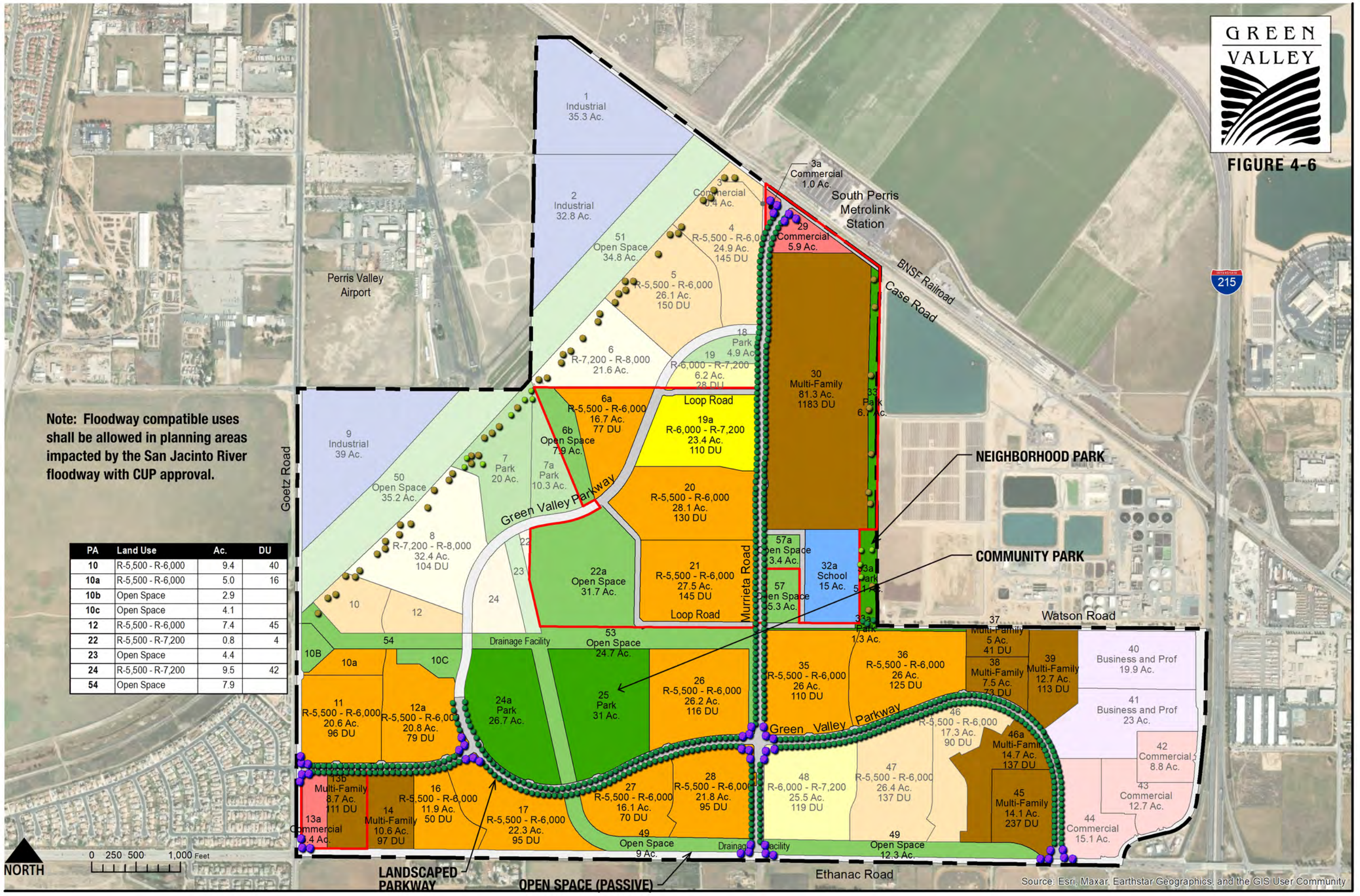






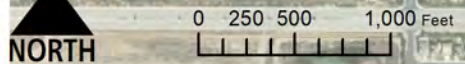
FIGURE 4-6

LANDSCAPE PLAN



Note: Floodway compatible uses shall be allowed in planning areas impacted by the San Jacinto River floodway with CUP approval.

PA	Land Use	Ac.	DU
10	R-5,500 - R-6,000	9.4	40
10a	R-5,500 - R-6,000	5.0	16
10b	Open Space	2.9	
10c	Open Space	4.1	
12	R-5,500 - R-6,000	7.4	45
22	R-5,500 - R-7,200	0.8	4
23	Open Space	4.4	
24	R-5,500 - R-7,200	9.5	42
54	Open Space	7.9	



NORTH

Source: Esri, Maxar, Earthstar Geographics, and the GIS User Community



#### 4.4.3 Community Identity Plan/Monumentation

Appropriate community, mixed-use areas and residential neighborhood thematic identification is important in establishing a new community and maintaining the overall Green Valley theme, as well as providing a system for identifying community development and giving directional information to residents and visitors. A general conceptual Community Identity Signage/ Monumentation Program has been provided herein.

Entry monument signage, through decorative typefaces and symbolic graphics, will inform the visitor that they are entering a planned community. Project and neighborhood signage will direct visitors who have entered Green Valley towards the distinct community components and amenities. Monument signage will be consistent with the character of the project, but flexible enough to respond to individual project contexts. Logos, type styles, color schemes, and architectural features should be consistent throughout the area being identified. Monument signs may vary in size and detail in a manner that reflects their relative importance within the signage hierarchy, but will incorporate all the materials proposed within the major community monumentation.

##### **Materials:**

- Mix of stone on monuments
- Brass-looking and/or concrete cast signage
- Natural large timber wood trellis components
- Poured-in-place concrete components
- Specimen Trees with complementary plant material selections

Figure 4-7 depicts the overall Monumentation Plan, and Figure 4-8 depicts the location of the Phase I monuments.



*Examples of Proposed Stone Mix:  
60% Italian Villa, color Verona  
40% Tuscan Villa, color Florentine  
Manufacturer: Coronado Stone*





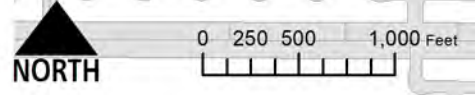
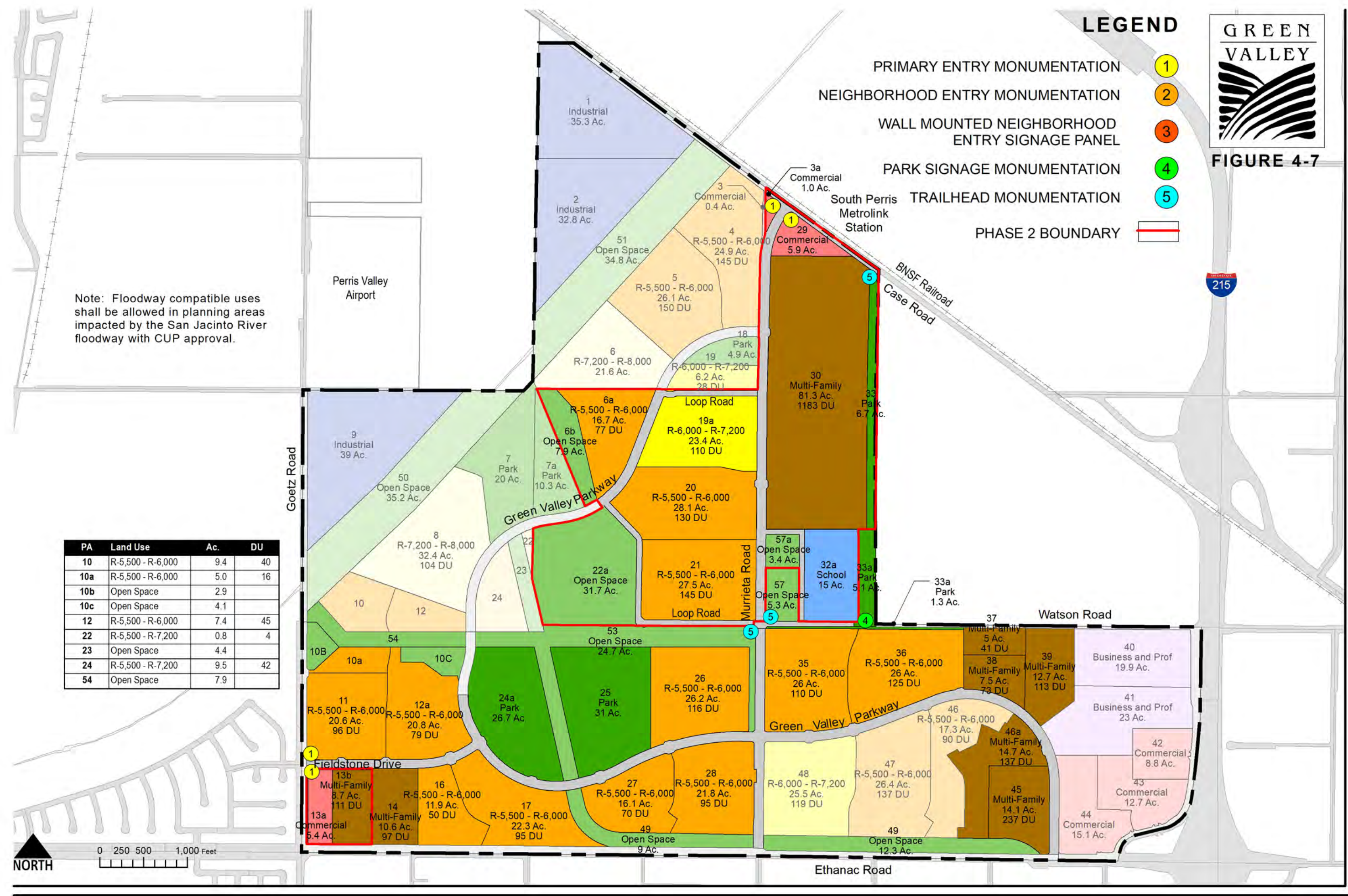
FIGURE 4-7

**LEGEND**

- PRIMARY ENTRY MONUMENTATION ①
- NEIGHBORHOOD ENTRY MONUMENTATION ②
- WALL MOUNTED NEIGHBORHOOD ENTRY SIGNAGE PANEL ③
- PARK SIGNAGE MONUMENTATION ④
- TRAILHEAD MONUMENTATION ⑤
- PHASE 2 BOUNDARY

Note: Floodway compatible uses shall be allowed in planning areas impacted by the San Jacinto River floodway with CUP approval.

PA	Land Use	Ac.	DU
10	R-5,500 - R-6,000	9.4	40
10a	R-5,500 - R-6,000	5.0	16
10b	Open Space	2.9	
10c	Open Space	4.1	
12	R-5,500 - R-6,000	7.4	45
22	R-5,500 - R-7,200	0.8	4
23	Open Space	4.4	
24	R-5,500 - R-7,200	9.5	42
54	Open Space	7.9	



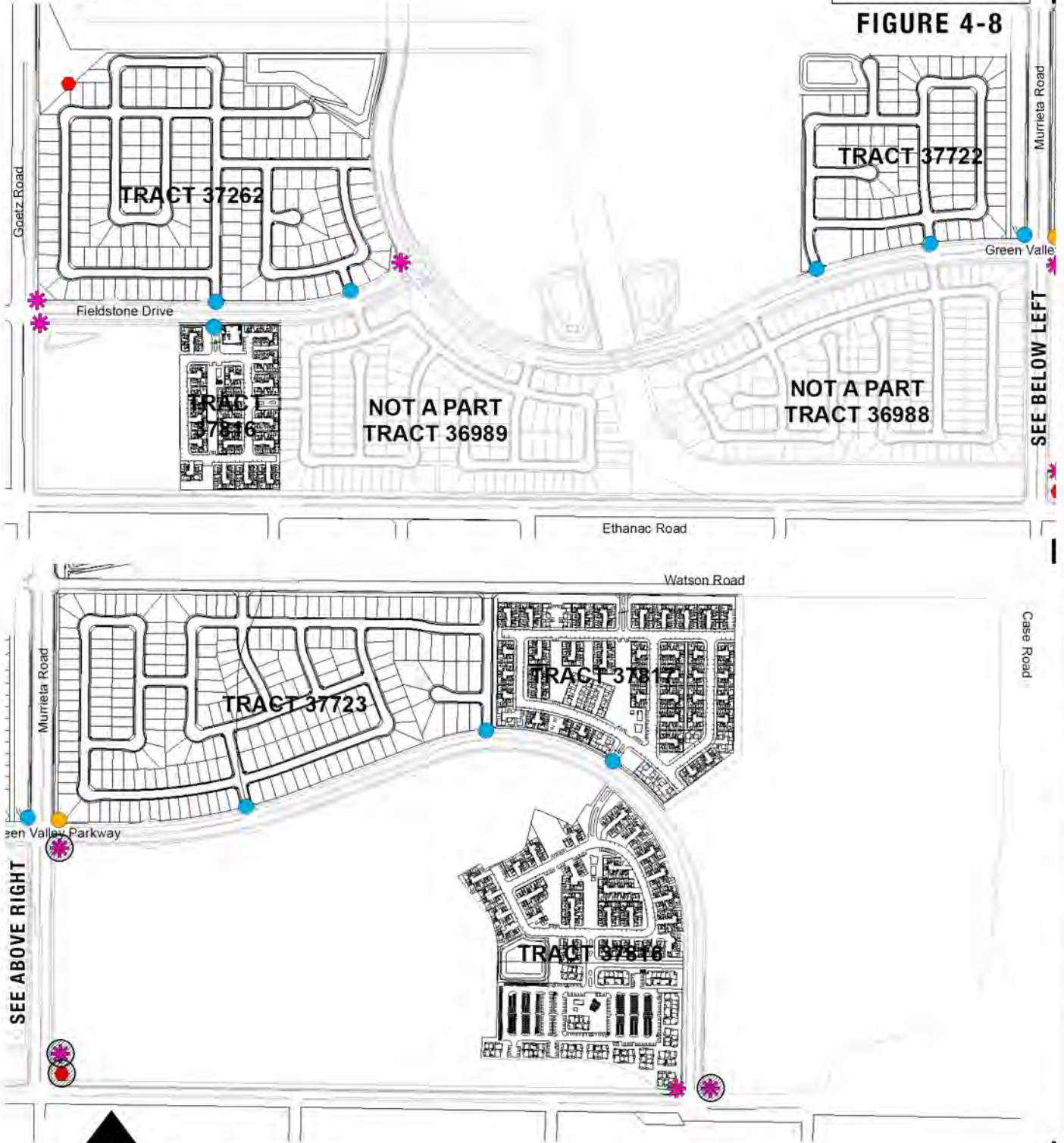


MONUMENTATION KEY MAP PHASE 1

-  Primary Entry
-  Neighborhood Entry Monument
-  Wall Mounted Neighborhood Entry Sign
-  Trailhead Marker
-  Park
-  Not A Part



FIGURE 4-8



Not to Scale



**Primary Entry Identification Signage:** Primary Entry Identification Signage will be located at the main entrances to the Green Valley development, at access points at the intersection Goetz Road and Fieldstone Drive, at the intersection of Murrieta Road and Green Valley Parkway, and at Murrieta Road and the Romoland Channel. These community monuments will be the largest of the signage program and will be a timeless mix of stone, brass-looking and/or cast concrete signage panel, and natural large timber wood components. Primary Entry Signage sizes may vary to reflect grading and infrastructure constraints. Figures 4-9 and 4-10 illustrate the Primary Entry Monumentation, Elevation and Plan Views.

**Neighborhood Entry Signage:** Neighborhood Entry Signage will be used to identify the various residential neighborhood entry points within the Green Valley community and be visually identifiable within each District. The entry signage monumentation for each district incorporates the design elements of a mix of stone and brass-looking and/or cast concrete signage panels inset into the stone. Figures 4-11 and 4-12 depict Neighborhood Entry Monumentation and Options.

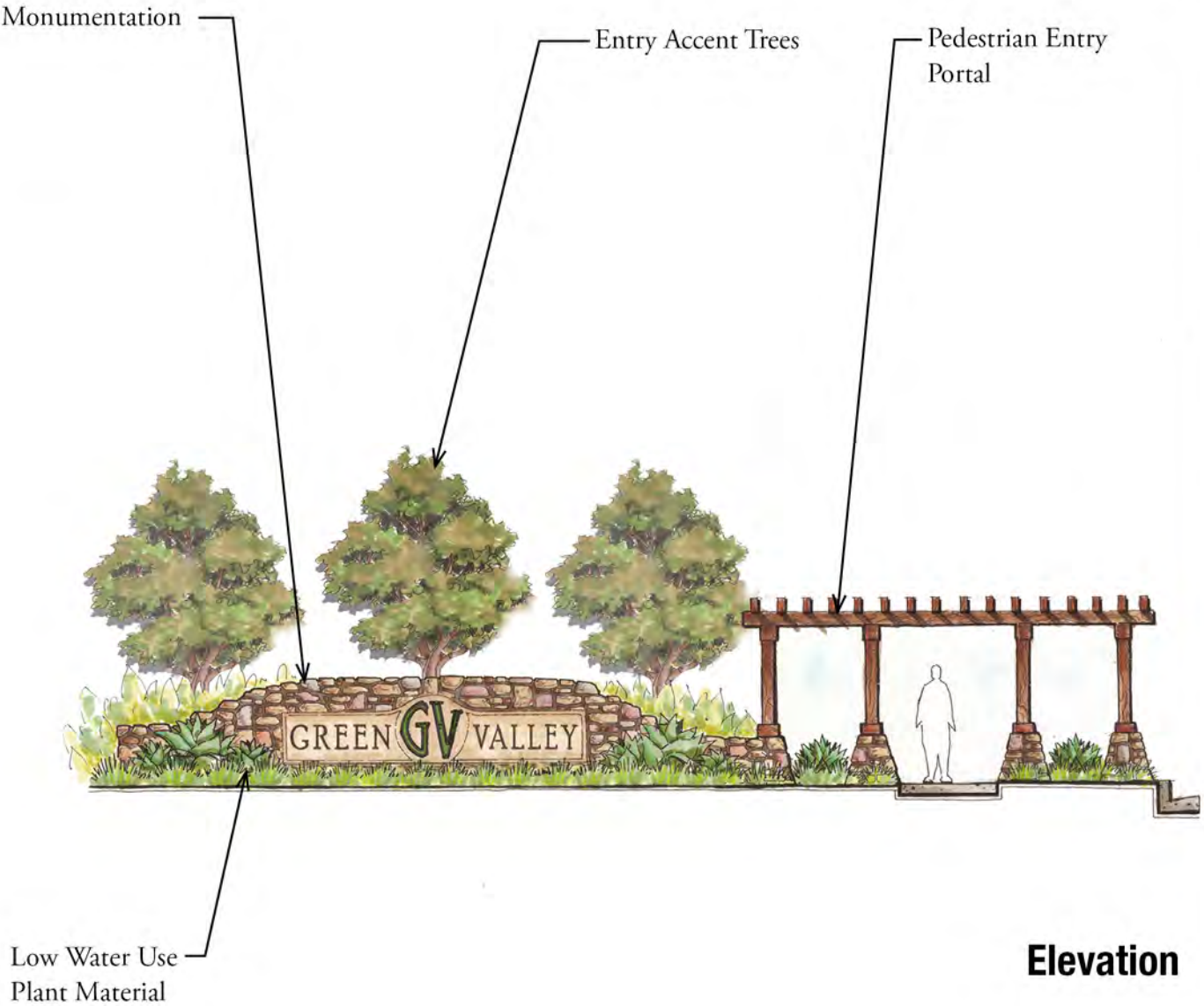
**Park Signage:** Park Signage will identify park and recreation spaces throughout the Green Valley development. The design of the signage is similar to the Neighborhood residential neighborhood for ease of district identification, but will be constructed at a smaller scale. Community park signage will adhere to the City standards for park monumentation. See Figure 4-13, Community Public Park Monumentation.

**Trailhead Marker:** Trailhead Markers are located at any points where a trail connects to a roadway or intersection. These trail wayfinding indicators have accent design elements that match the community monumentation. The Trailhead Markers are a simpler design at a smaller scale. They are compatible with their surroundings and aesthetically pleasing. See Figure 4-14, HOA Park and Trailhead Monumentation.



FIGURE 4-9

PRIMARY ENTRY MONUMENTATION

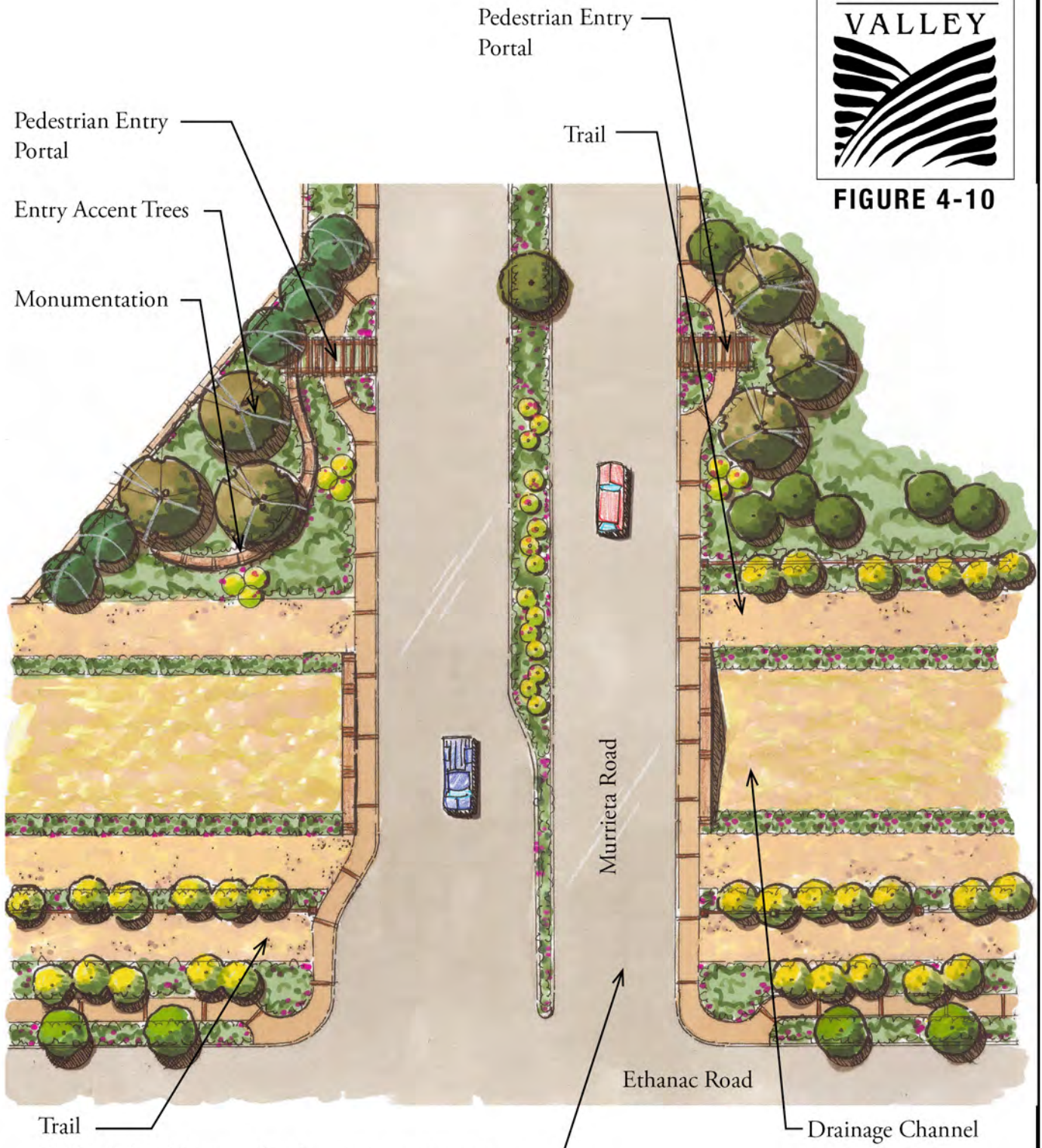


Not to Scale





FIGURE 4-10



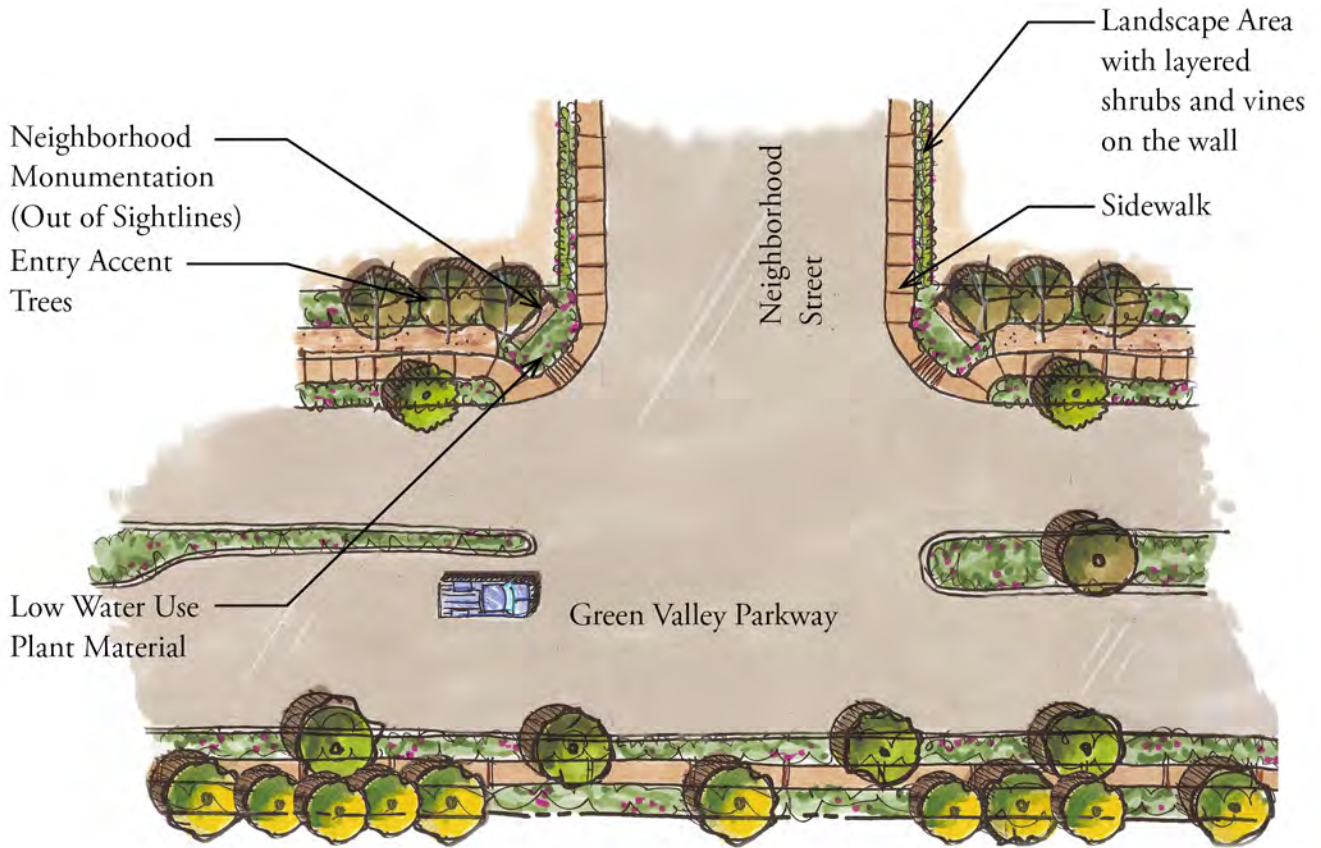
Field: Holland Stone vehicular concrete pavers in Herringbone pattern. Color: Old Town Blend by Ackerstone (or equivalent) Band: Nat. Gray Concrete with smooth trowel finish to match width of gutter

Plan View

Not to Scale



FIGURE 4-11



Plan View

LOCATION

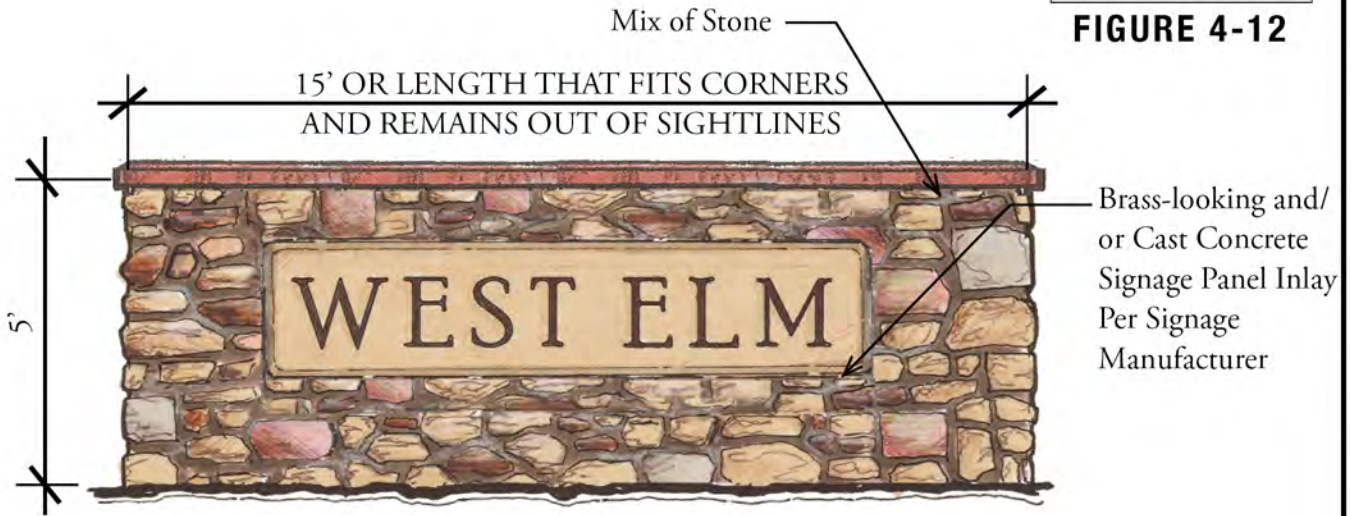
Not to Scale

NEIGHBORHOOD ENTRY MONUMENTATION





**FIGURE 4-12**



THE RANCH

The Stroll

THE STATION

Examples of Possible Individual Signage Panel Inlays/Font Types

Not to Scale

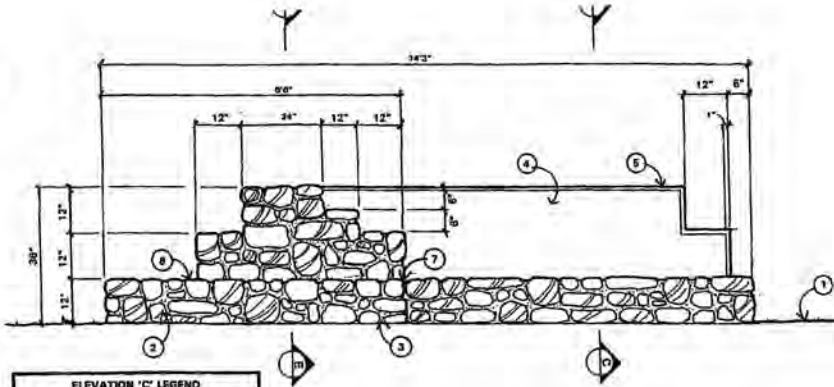
**OPTIONS**





FIGURE 4-13

COMMUNITY PUBLIC PARK MONUMENTATION

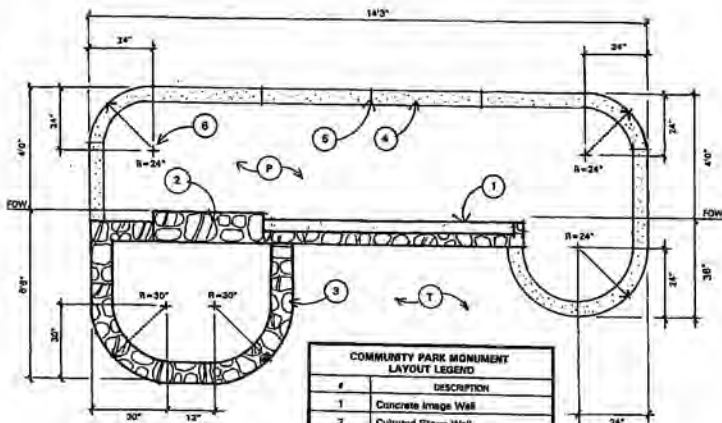


ELEVATION 'C' LEGEND	
#	DESCRIPTION
1	Finish Grade
2	Cultured Stone
3	Gray Mortar
4	Concrete Sign Image Panel
5	1" Notch Review
6	Cultured Stone Cap
7	Edge of Planter
8	Planter Wall

Refer to 'Materials / Finish Schedule' sheets 4.1

SCALE 3/4" = 1'-0"

PROJECT	3.1	City of Perris Park Sign Walls	PROJECT NO.	TBLA
DATE	Jul 1985	COMMUNITY PARK ELEVATION 'C'		



COMMUNITY PARK MONUMENT LAYOUT LEGEND	
#	DESCRIPTION
1	Concrete Image Wall
2	Cultured Stone Wall
3	Planter Wall
4	6" sq. Concrete Mow Curb
5	Control Joint
6	Radius Point Location
T	Turf
P	Planting Area

Refer to 'Materials / Finish Schedule' sheets 4.1

SCALE 1/2" = 1'-0"

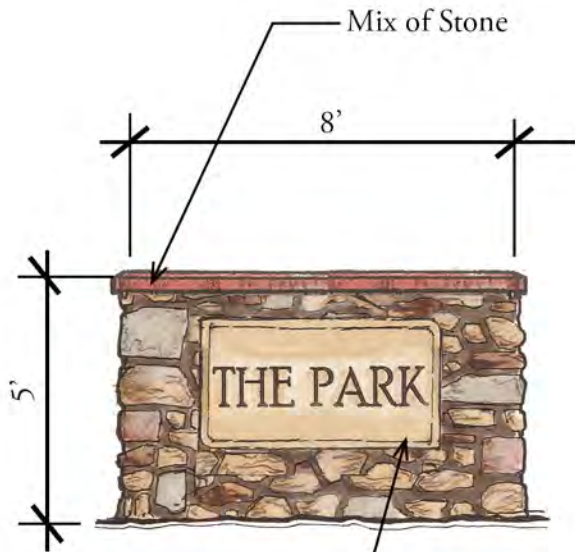
PROJECT	3.4	City of Perris Community Park Wall Layout Plan	PROJECT NO.	TBLA
DATE	Jul 1985	COMMUNITY PARK WALL LAYOUT PLAN		

Not to Scale

PER CITY STANDARDS



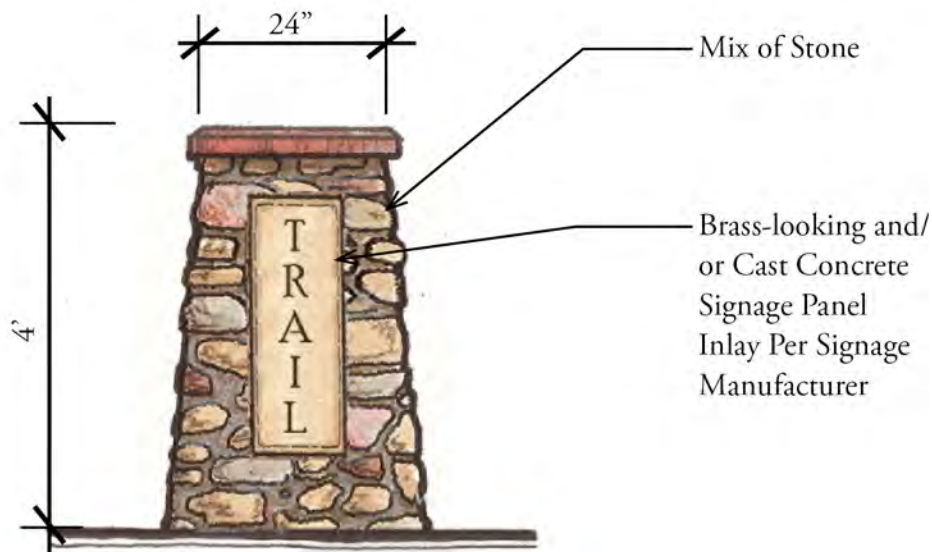
FIGURE 4-14



Brass-looking and/or Cast  
Concrete Signage Panel Inlay  
Per Signage Manufacturer

Examples of Possible Individual  
Signage Panel Inlays/Font Types

### HOA Park Monumentation Options



### Trailhead Monumentation

Not to Scale



#### 4.4.4 Parks

Per the City of Perris’ Parks and Recreation Master Plan, community parks are intended to provide community-wide recreational facilities and a greater variety of recreation opportunities than a neighborhood park. Community parks can provide a wide variety of uses and can also serve neighborhood park needs for the immediate neighborhood. The usable size of a community park is between fifteen to forty acres - the size of the park site is subject to final review and approval by the City Council. A community park usually serves several neighborhoods within one to two miles. Figure 4-15 depicts the location of Parks and Open Space within Green Valley.

Neighborhood parks are intended to provide for the daily recreation needs of residents in the immediate vicinity of the park. Primary uses can include passive, open space, active play area, picnic areas, and practice play fields with limited lighted facilities. The usable size of a neighborhood park is between five to fourteen acres.

Park design shall incorporate the following principles:

- Landscape buffers will be located adjacent to streets to provide visual relief.
- Play apparatus will be utilized to provide creative recreational situations.
- Detailed programs for landscaping and play apparatus will be prepared by a qualified landscape architect. The City of Perris staff and decision-making agencies will review the designs at the time of final tract map approval.
- Adult supervision of play areas will be facilitated through the development of viewing areas.
- Pathways will be designed for access by strollers and children’s play vehicles.
- There should be a minimum of two access points into each tot lot/playground area, if possible.
- An area of turf will be provided for creative play.
- An engineered wood fiber (ADA Accessible), sand base, or rubberized play surfacing shall be provided under all play apparatus in the interest of public safety.

Refer to the City of Perris Parks and Recreation Master Plan for additional park development standards.

Ten HOA pocket parks that vary in size are located within Phase 1 of the Green Valley project. Future phases will likely have HOA pocket parks within neighborhoods. In addition, the drainage channel open space corridor will provide passive open space opportunities with a trail system that connects the adjacent communities to the open space. The HOA pocket parks within Phase 1 may include program elements such as informal seating areas, trails and pathways, bike parking, picnic areas, pool area, bocce ball courts, dog park, and age- separated playgrounds. The park facilities and structures should be aesthetically tied to the “Early California” community design theme. The facilities should adopt and consider the architectural styles (including use of color and materials) defined in these design guidelines. Phase 1 HOA pocket parks locations are illustrated on Figure 4-16. Figures 4-17 through 4-26 depict illustrations of the HOA pocket parks.



# PARKS & OPEN SPACE KEY MAP



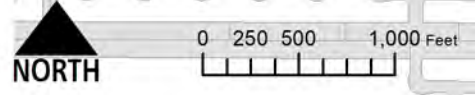
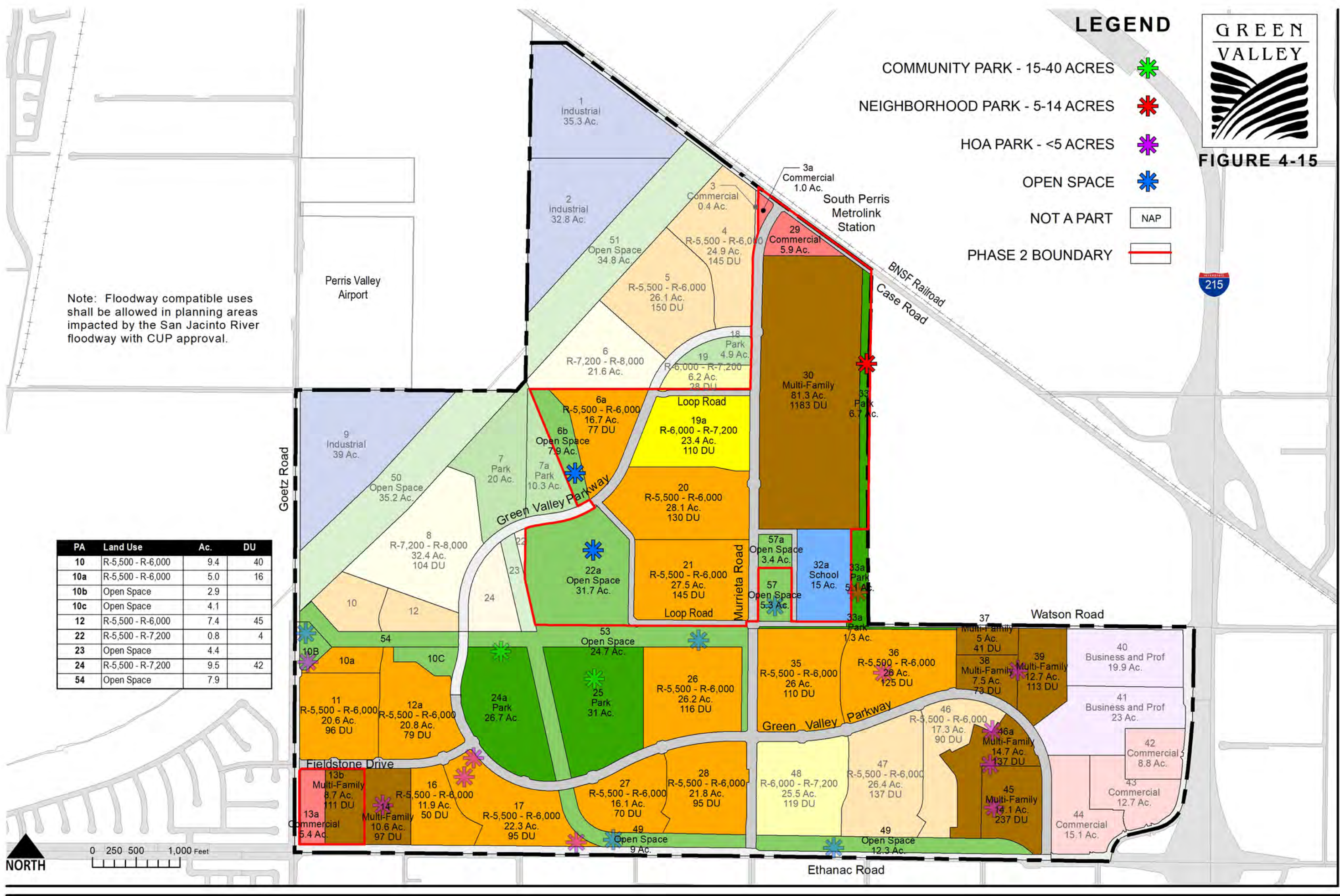
**FIGURE 4-15**

## LEGEND

- COMMUNITY PARK - 15-40 ACRES ✱
- NEIGHBORHOOD PARK - 5-14 ACRES ✱
- HOA PARK - <5 ACRES ✱
- OPEN SPACE ✱
- NOT A PART NAP
- PHASE 2 BOUNDARY

Note: Floodway compatible uses shall be allowed in planning areas impacted by the San Jacinto River floodway with CUP approval.

PA	Land Use	Ac.	DU
10	R-5,500 - R-6,000	9.4	40
10a	R-5,500 - R-6,000	5.0	16
10b	Open Space	2.9	
10c	Open Space	4.1	
12	R-5,500 - R-6,000	7.4	45
22	R-5,500 - R-7,200	0.8	4
23	Open Space	4.4	
24	R-5,500 - R-7,200	9.5	42
54	Open Space	7.9	





L M D & H O A A R E A S P H A S E 1



FIGURE 4-16

- HOA Park
- HOA Common Area
- LMD Area



Not to Scale

SEE ABOVE RIGHT

SEE BELOW LEFT





FIGURE 4-17



Not to Scale

H  
O  
A  
  
P  
A  
R  
K  
  
1  
  
T  
R  
A  
C  
T  
  
3  
6  
9  
8  
9





FIGURE 4-18



Not to Scale

H  
O  
A  
  
P  
A  
R  
K  
  
2  
  
T  
R  
A  
C  
T  
  
3  
6  
9  
8  
9



FIGURE 4-19



Not to Scale

H  
O  
A  
  
P  
A  
R  
K  
  
3  
  
T  
R  
A  
C  
T  
  
3  
6  
9  
8  
9





FIGURE 4-20

H  
O  
A  
  
P  
A  
R  
K  
  
T  
R  
A  
C  
T  
  
3  
7  
2  
6  
2



Not to Scale





FIGURE 4-21

H  
O  
A  
P  
A  
R  
K  
T  
R  
A  
C  
T  
3  
7  
2  
2  
3



Not to Scale



FIGURE 4-22

HOA  
PARK  
TRACT  
37816



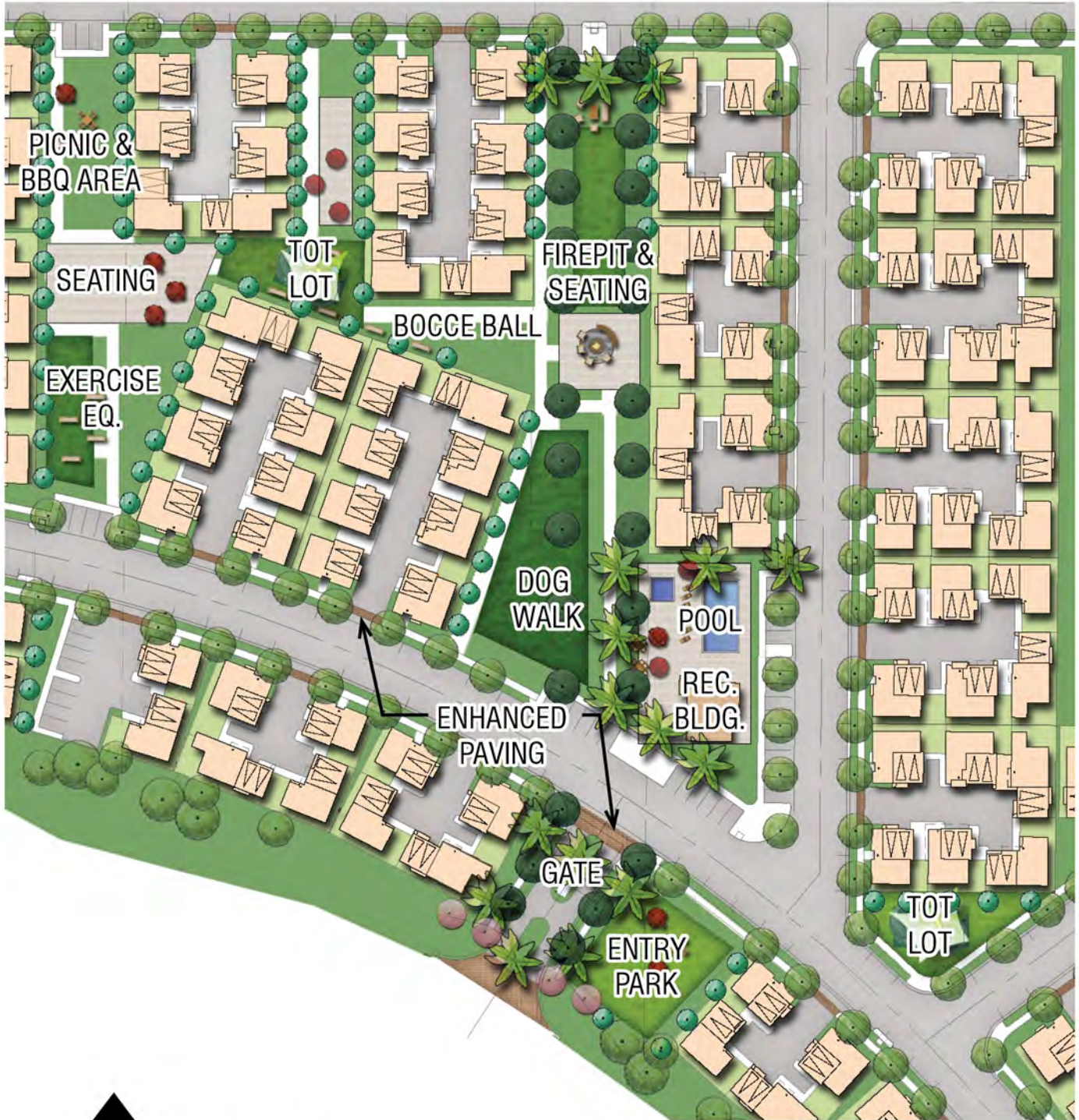
Not to Scale





FIGURE 4-23

H  
O  
A  
  
P  
A  
R  
K  
  
T  
R  
A  
C  
T  
  
3  
7  
8  
1  
7



Not to Scale







FIGURE 4-24

H  
O  
A  
  
P  
A  
R  
K  
  
1  
  
T  
R  
A  
C  
T  
  
3  
7  
8  
1  
8



Not to Scale





FIGURE 4-25

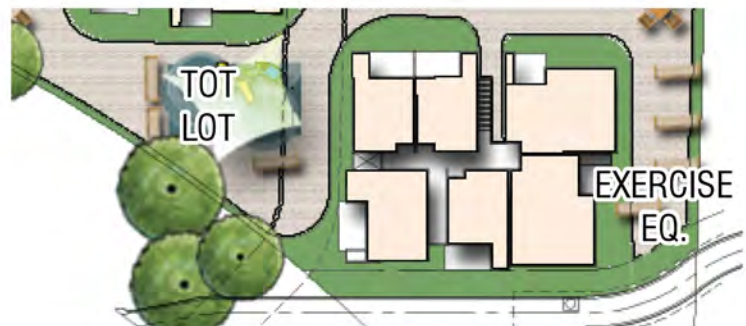


H  
O  
A  
  
P  
A  
R  
K  
  
2  
  
T  
R  
A  
C  
T  
  
3  
7  
8  
1  
8





FIGURE 4-26



Not to Scale





#### **4.4.5 TOT LOTS/PLAYGROUNDS**

The purpose of these guidelines is to develop unique, open-space play areas within the fabric of the community. These tot lot/playgrounds will enhance the neighborhood image by providing convenient locations for families to enjoy the atmosphere of a creatively designed space.

- All play equipment shall preferably be a tot-lot (5-12-year-old) and provide a shade cover for all play equipment areas.
- Landscape buffers will be located adjacent to streets to provide visual relief.
- Play apparatus will be utilized to provide creative recreational situations.
- Detailed programs for landscaping and play apparatus will be prepared by a qualified landscape architect. The City of Perris staff and decision-making agencies will review the designs at the time of final tract map approval.
- Adult supervision of play areas will be facilitated through the development of viewing areas.
- Pathways will be designed for access by strollers and children’s play vehicles.
- There should be a minimum of two access points into each tot lot/playground area, if possible.
- An area of turf will be provided for creative play.
- Rubberized play surfacing or engineered wood fiber (approved for ADA access) shall be provided under all play apparatus in the interest of public safety.
- Where play area is near a street, a 42” high tube steel fence or a hedge form shrub that grows 36” to 42” minimum shall be provided adjacent to the street.

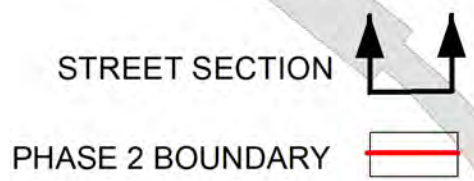
#### **4.4.6 Streetscape/Circulation Plan and Sections**

A few streetscape applications are proposed within the Green Valley development, as shown within this section. As illustrated in the following exhibits, a hierarchy of streetscapes within Green Valley is provided and distinctive landscape treatments are planned for each roadway. Landscape and hardscape treatments include elements such as landscaped medians, sidewalks, enhanced paving at pedestrian crossings and primary/secondary entries, bike trails, and parkway trees to enhance roadways. The main road will feature such landscape elements as signage, street furniture, and a predominant plant palette consisting of canopy trees on corner treatments and parkways, center medians where space allows, and vertical trees as backdrops within landscape lots. The use of enhanced paving is strongly encouraged. Figure 4-27 depicts the Streetscape Section Key Map, and Figures 4-28 through 4-36 illustrate the street sections throughout Green Valley.



FIGURE 4-27

**LEGEND**



Note: Floodway compatible uses shall be allowed in planning areas impacted by the San Jacinto River floodway with CUP approval.

PA	Land Use	Ac.	DU
10	R-5,500 - R-6,000	9.4	40
10a	R-5,500 - R-6,000	5.0	16
10b	Open Space	2.9	
10c	Open Space	4.1	
12	R-5,500 - R-6,000	7.4	45
22	R-5,500 - R-7,200	0.8	4
23	Open Space	4.4	
24	R-5,500 - R-7,200	9.5	42
54	Open Space	7.9	

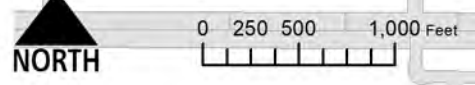
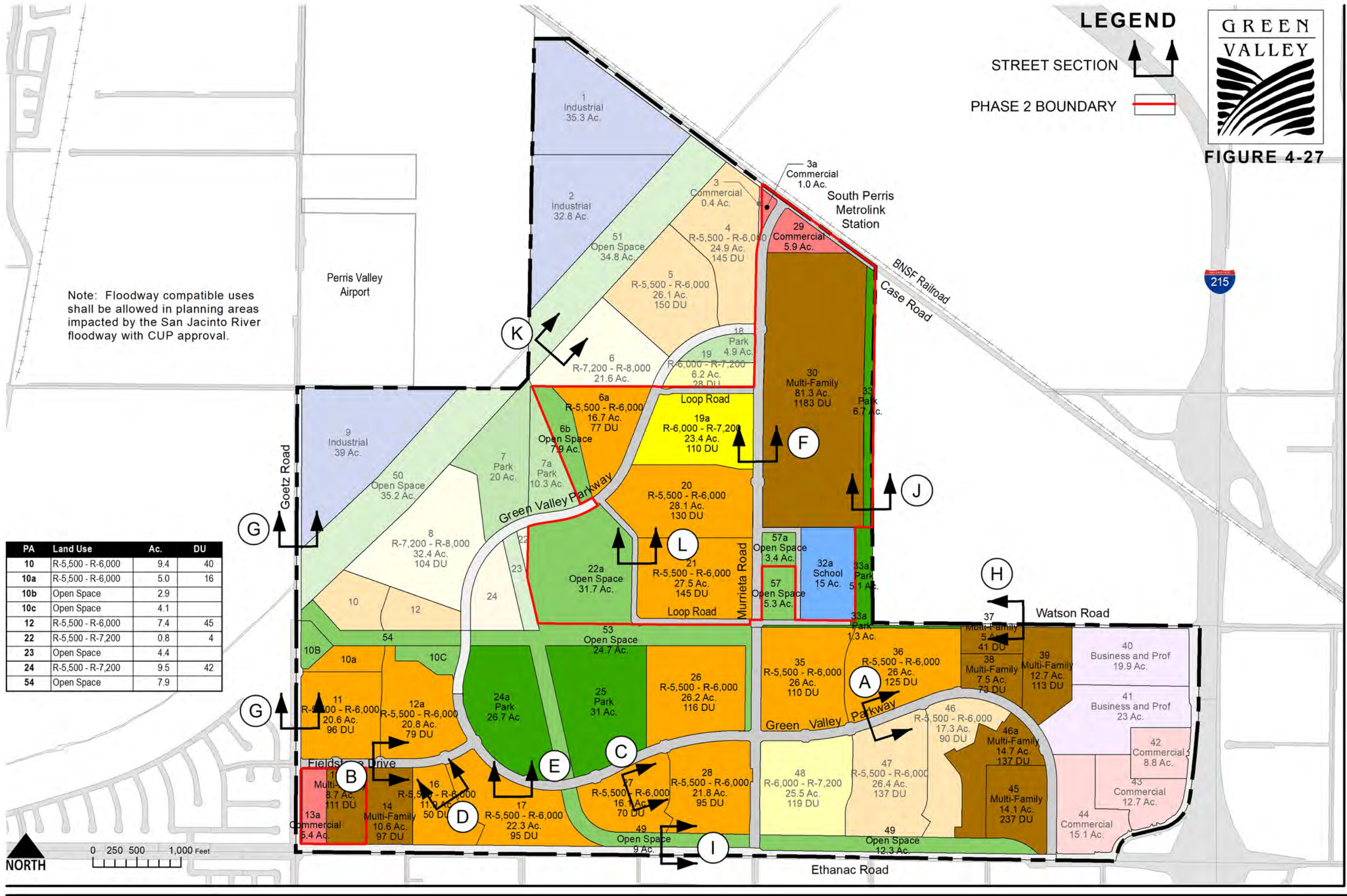
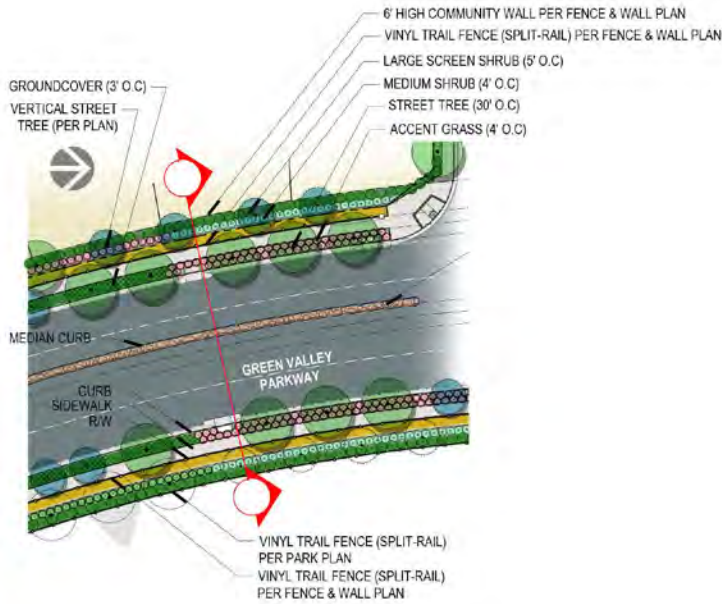
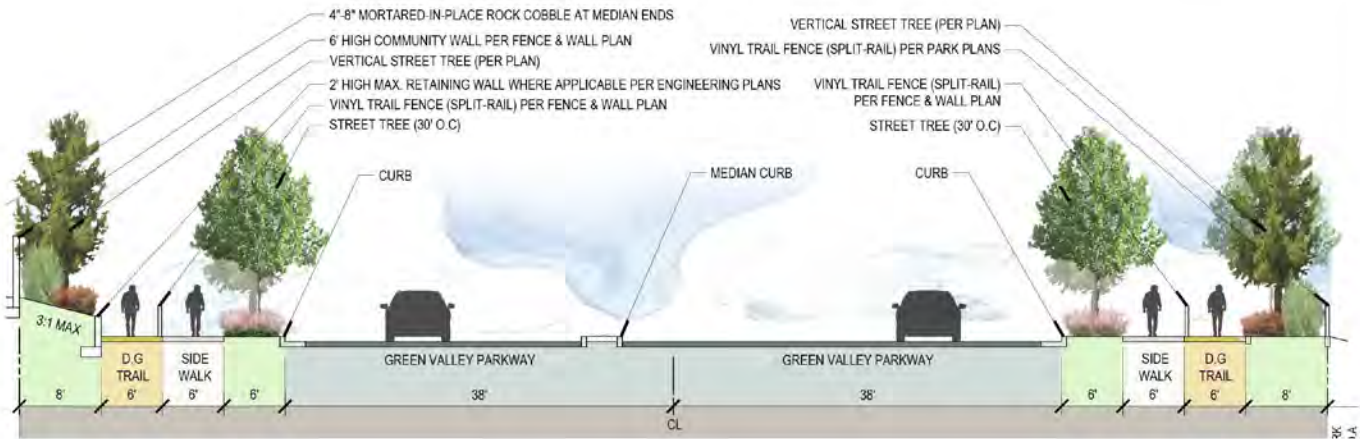






FIGURE 4-28

SECTION A GREEN VALLEY PARKWAY

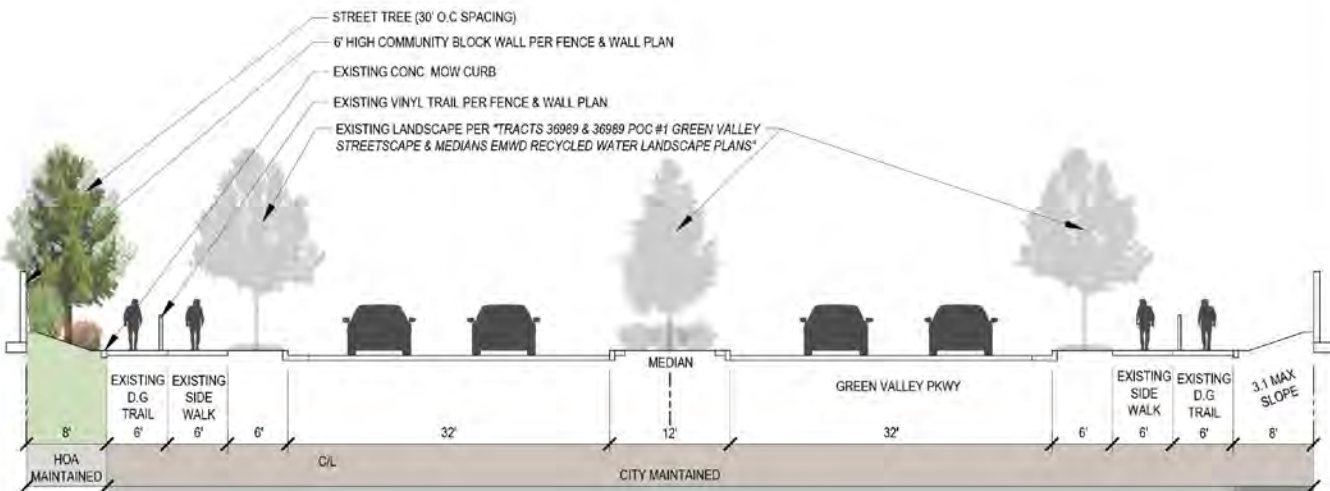
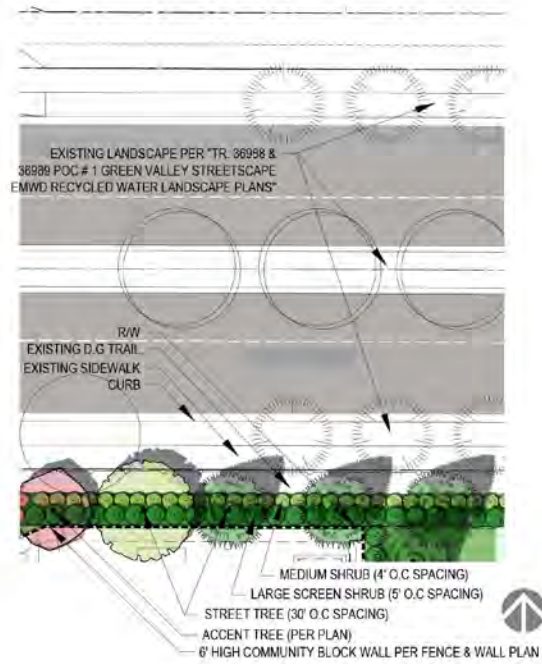




SECTION B  
FIELDSTONE DRIVE



FIGURE 4-29

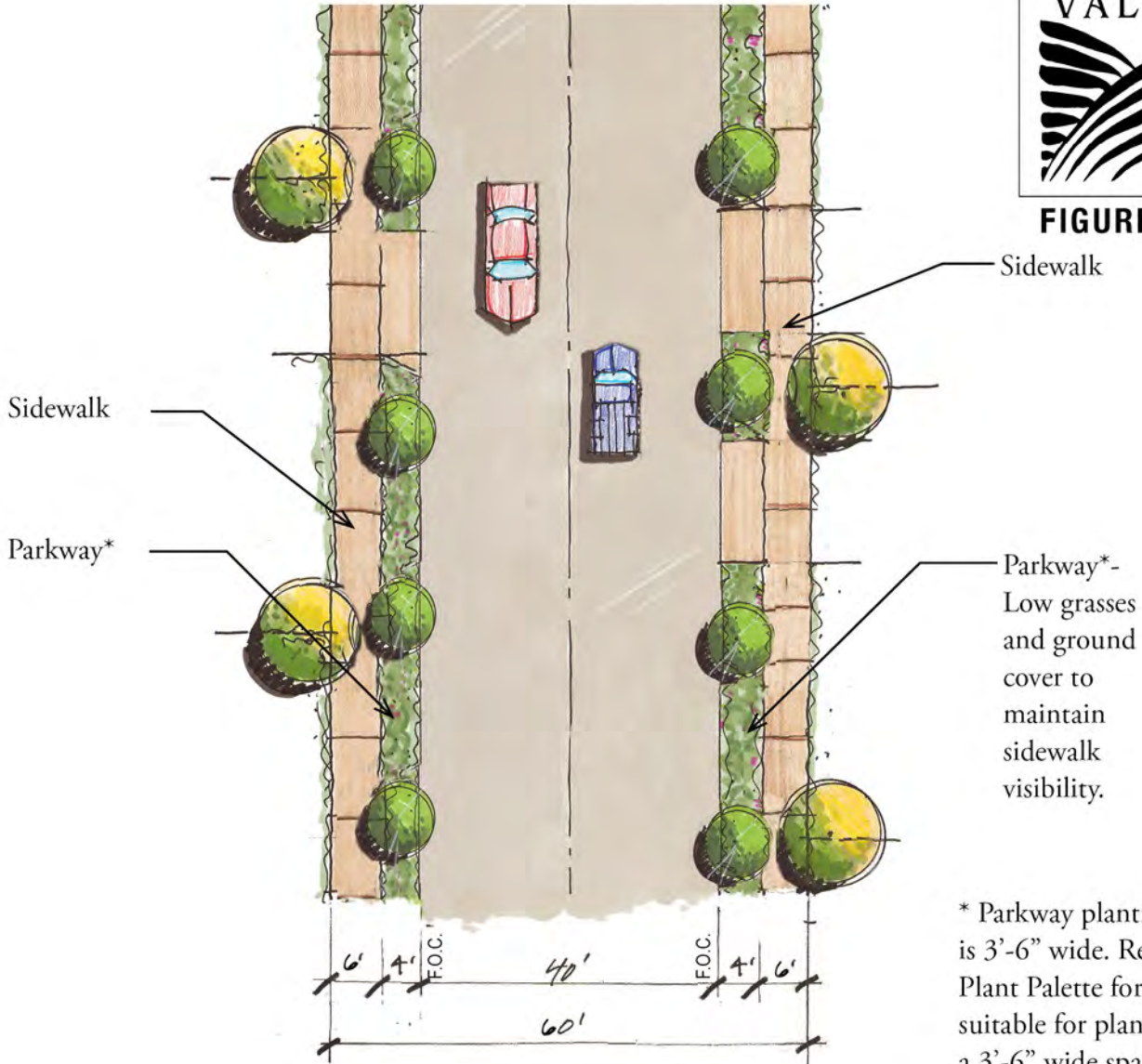


**B** Fieldstone Drive

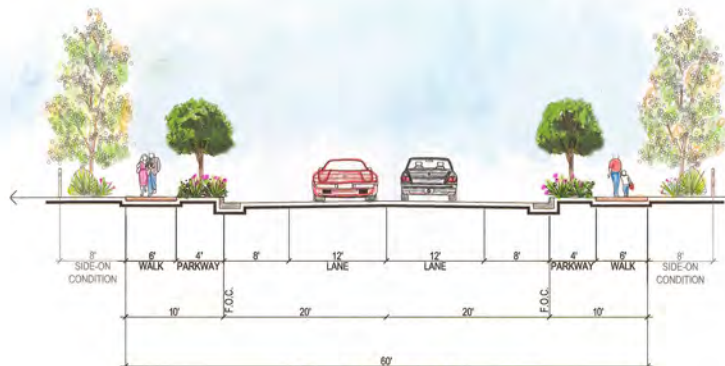
Not to Scale



FIGURE 4-30



\* Parkway planting area is 3'-6" wide. Refer to Plant Palette for TREES suitable for planting within a 3'-6" wide space.



Ⓒ Parkway Street  
Local Street- 40' Curb-to-Curb

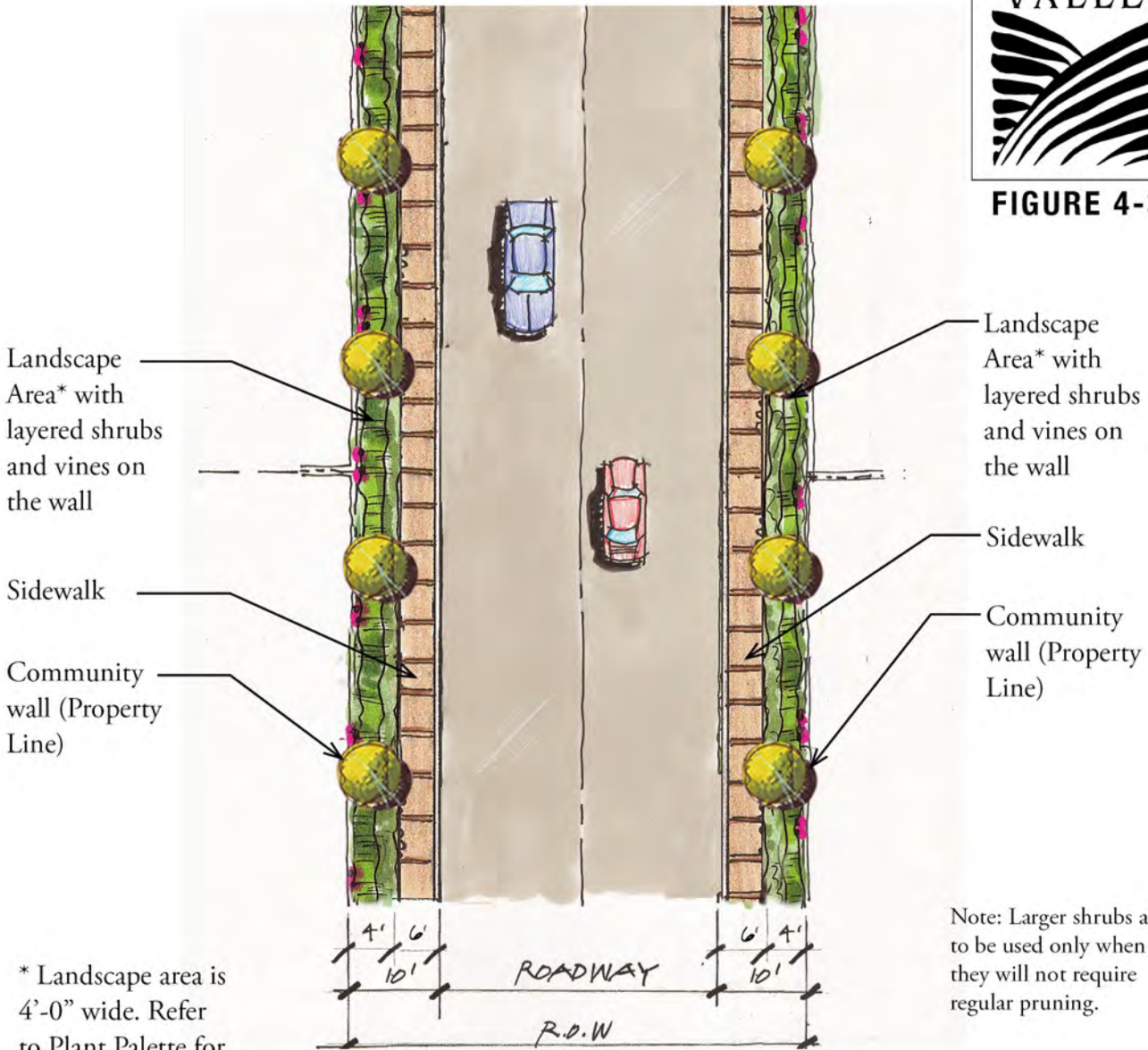
Not to Scale





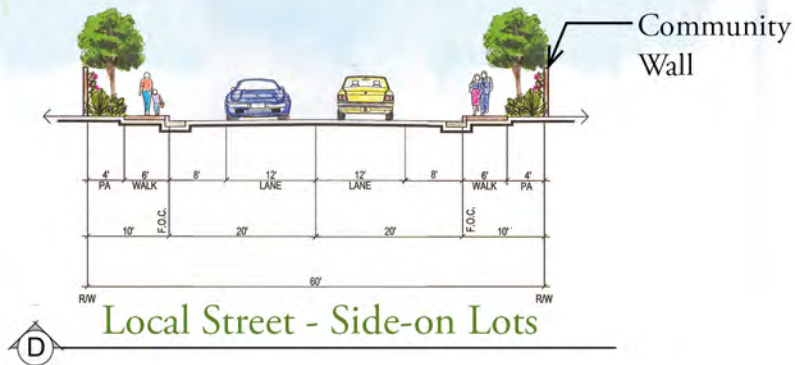


FIGURE 4-31



\* Landscape area is 4'-0" wide. Refer to Plant Palette for **TREES** suitable for planting within a 4'-0" wide space.

Note: Larger shrubs are to be used only when they will not require regular pruning.



Not to Scale





FIGURE 4-32

Landscape Area\* with layered shrubs and vines on the wall

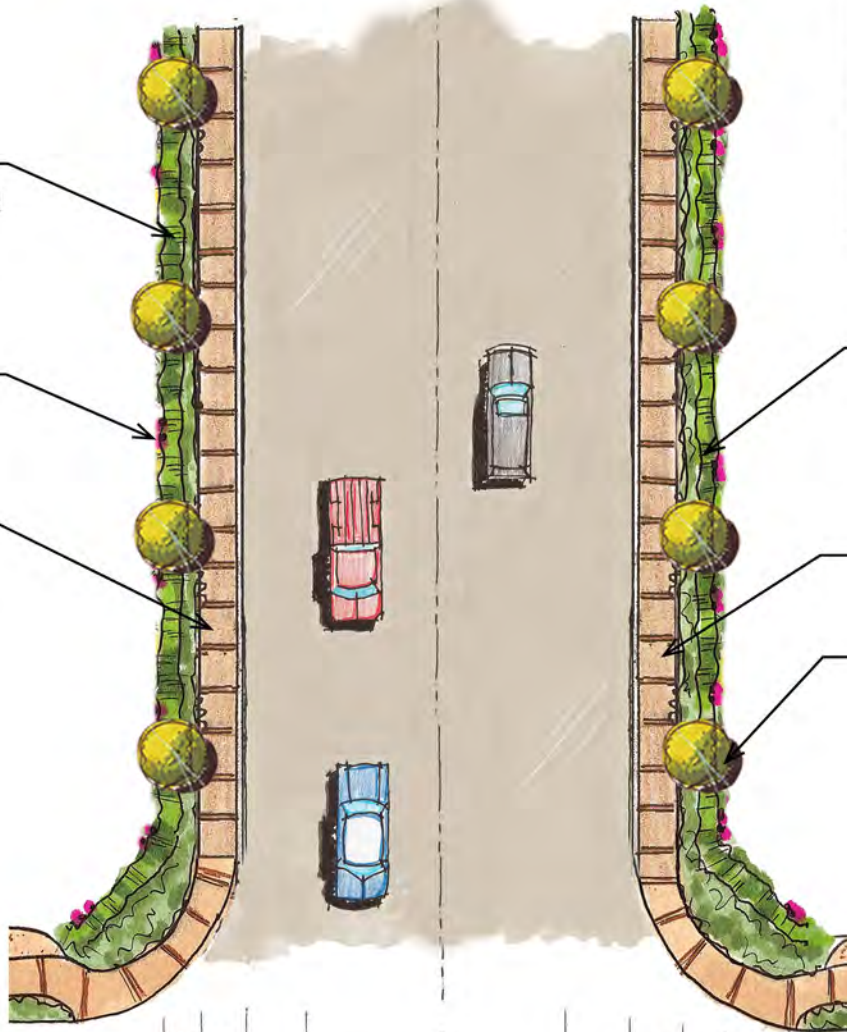
Community wall (Property Line)

Sidewalk

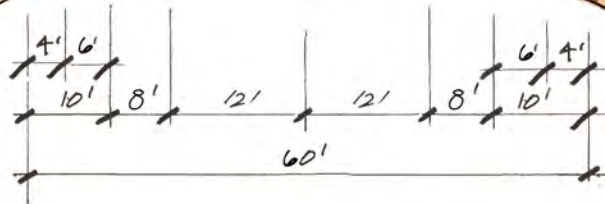
Landscape Area\* with layered shrubs and vines on the wall

Sidewalk

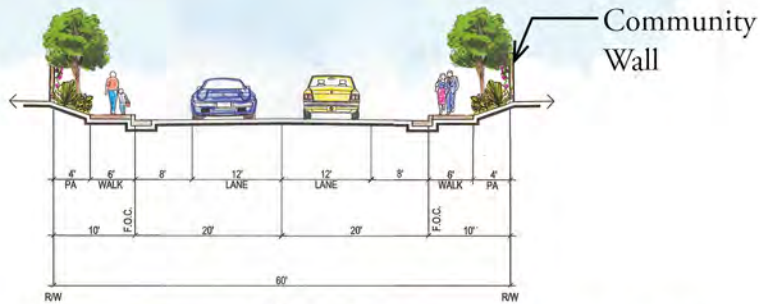
Community wall (Property Line)



Note: Larger shrubs are to be used only when they will not require regular pruning.



\* Landscape area is 4'-0" wide. Refer to Plant Palette for **TREES** suitable for planting within a 4'-0" wide space.



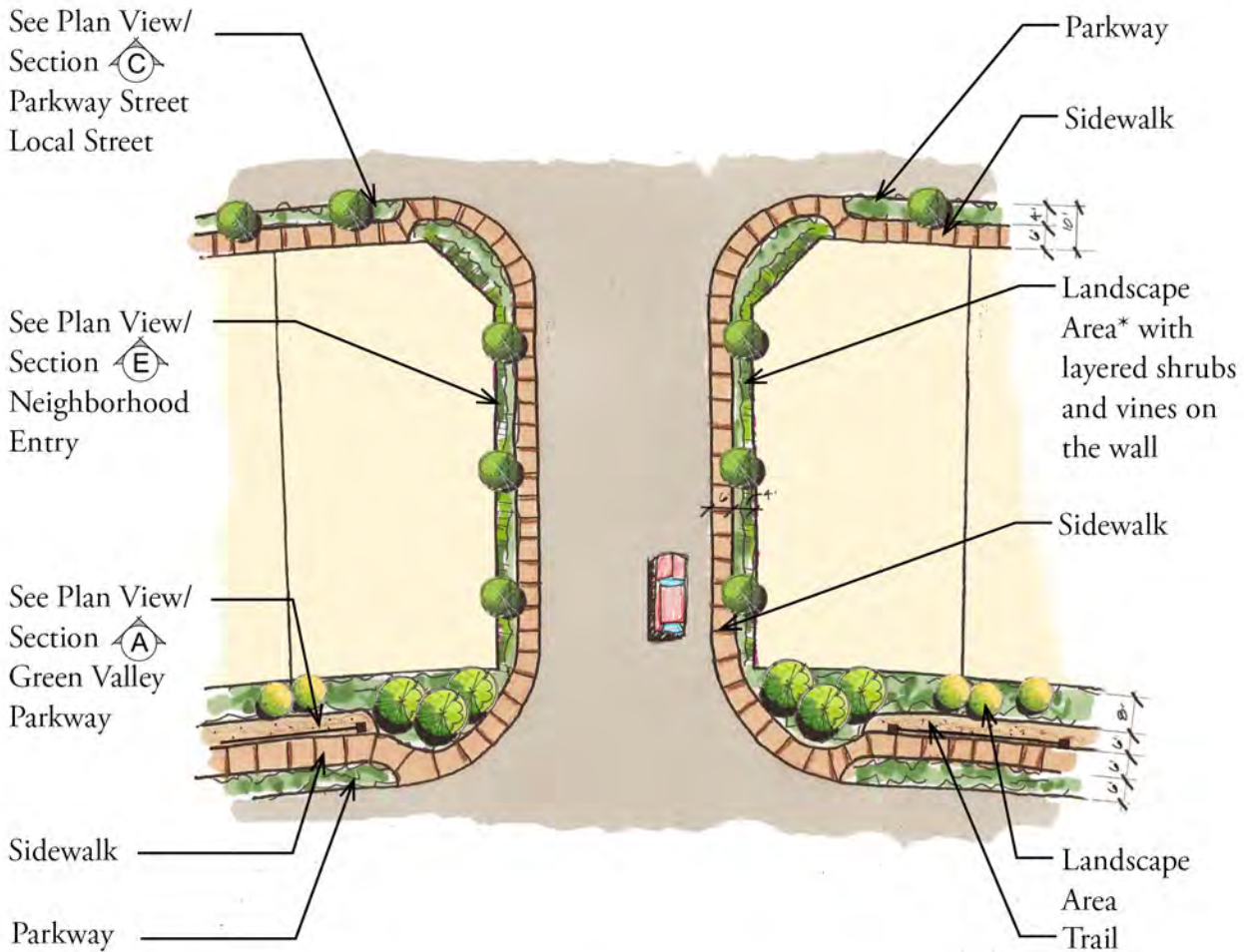
Neighborhood Entry- Side on Lots

Not to Scale





FIGURE 4-33



See Plan View/  
Section **C**  
Parkway Street  
Local Street

See Plan View/  
Section **E**  
Neighborhood  
Entry

See Plan View/  
Section **A**  
Green Valley  
Parkway

Sidewalk  
Parkway

Parkway  
Sidewalk

Landscape  
Area\* with  
layered shrubs  
and vines on  
the wall

Sidewalk

Landscape  
Area  
Trail

\* Landscape area is 4'-0" wide. Refer to Plant Palette for **TREES** suitable for planting within a 4'-0" wide space.

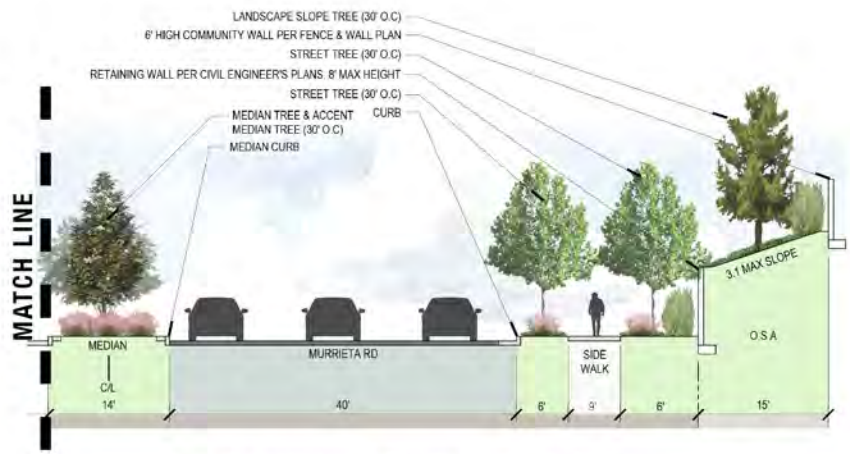
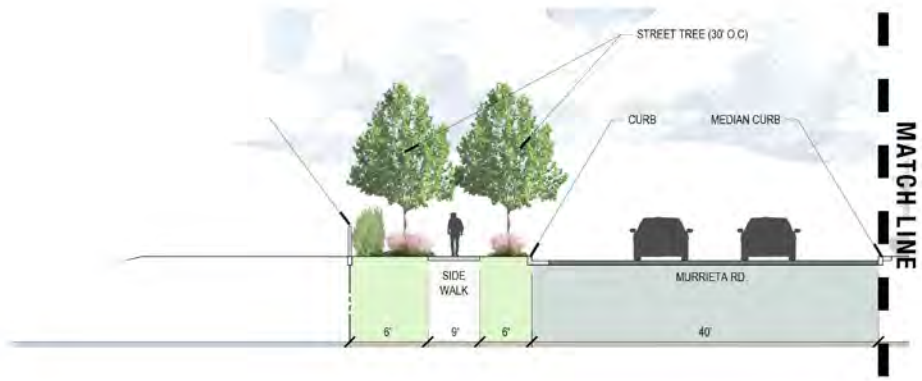
**A C E** Transition of Walks - Plan View

Not to Scale



FIGURE 4-34

SECTION F  
MURRIETA ROAD



F Murrieta Road - Section

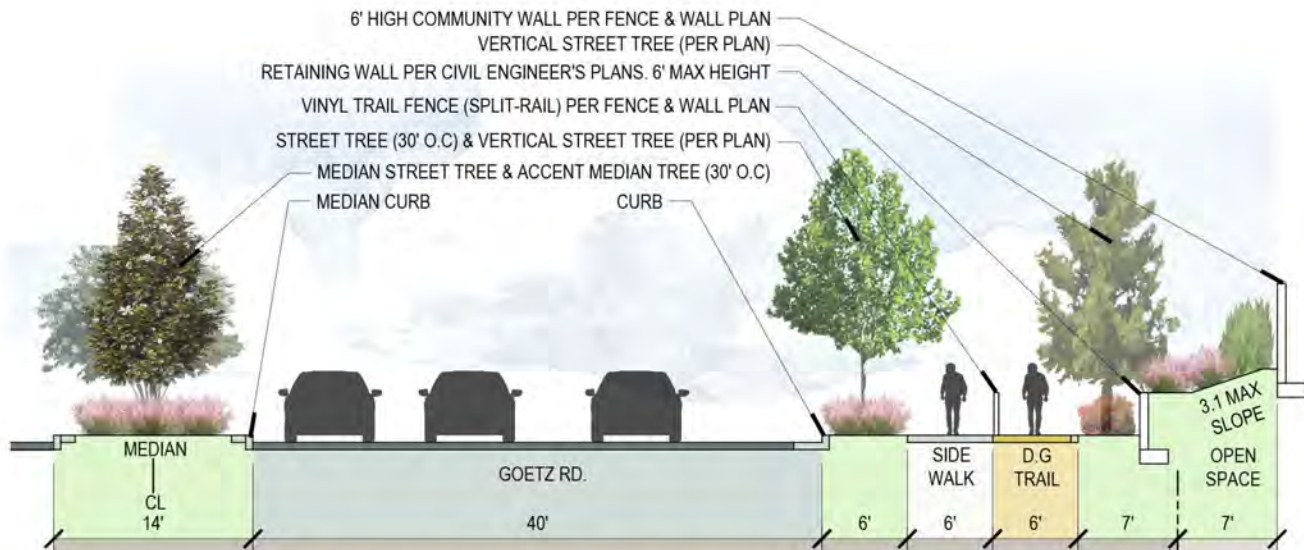
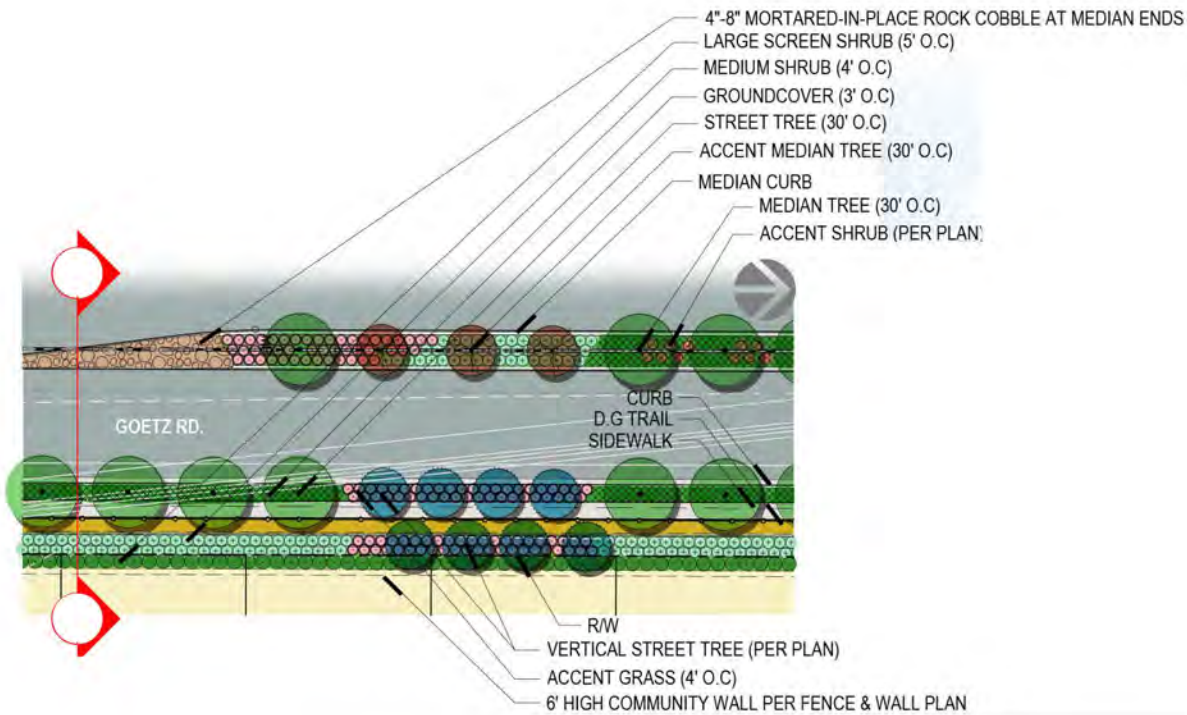
Not to Scale





**FIGURE 4-35**

**SECTION  
G  
GOETZ  
ROAD**



**Goetz Road - Section**

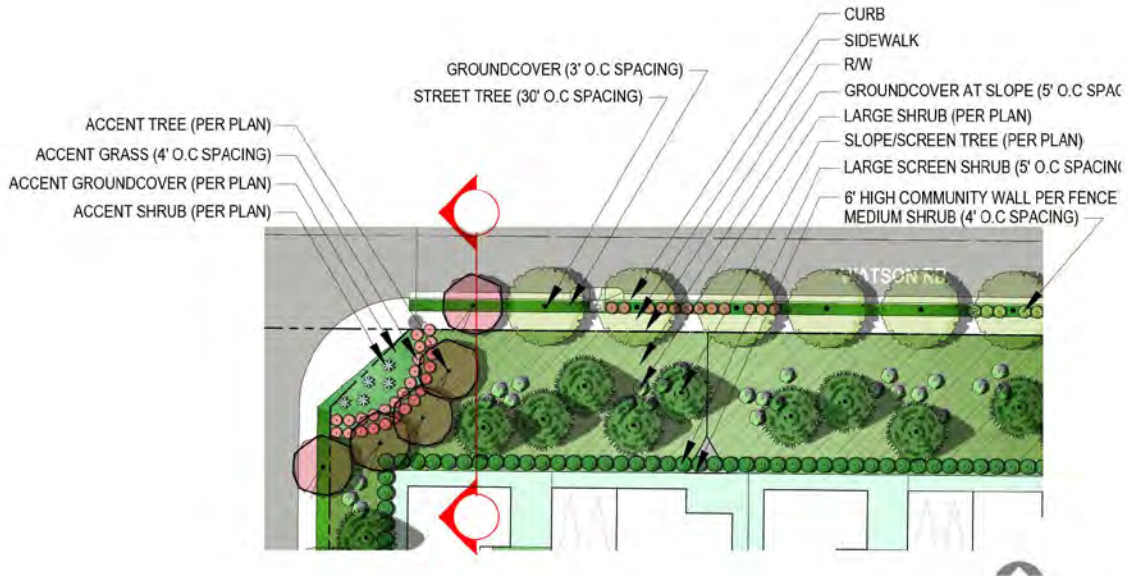
Not to Scale



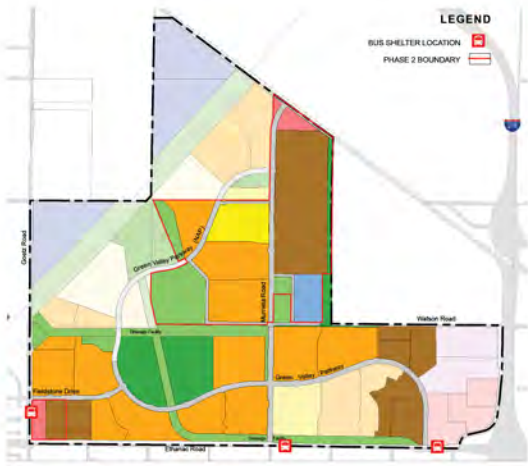


FIGURE 4-36

SECTION H  
WATSON ROAD





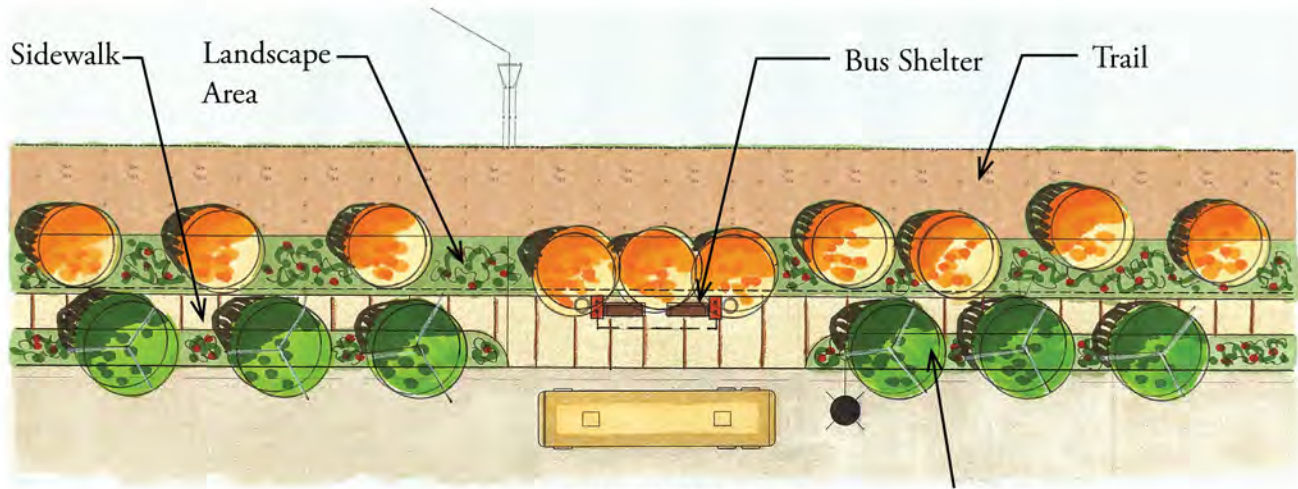


**Key Map**

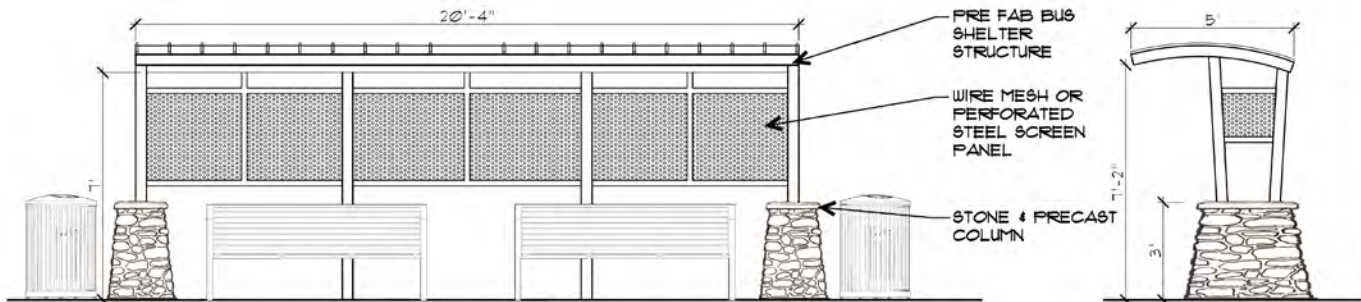


**FIGURE 4-37**

**B  
U  
S  
S  
H  
E  
L  
T  
E  
R**



**Plan View**

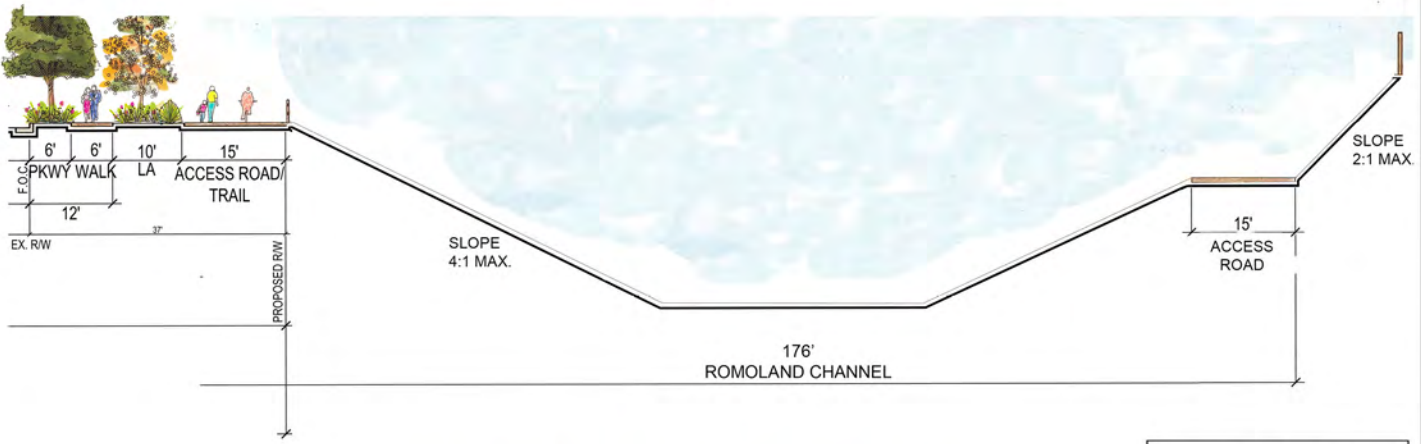
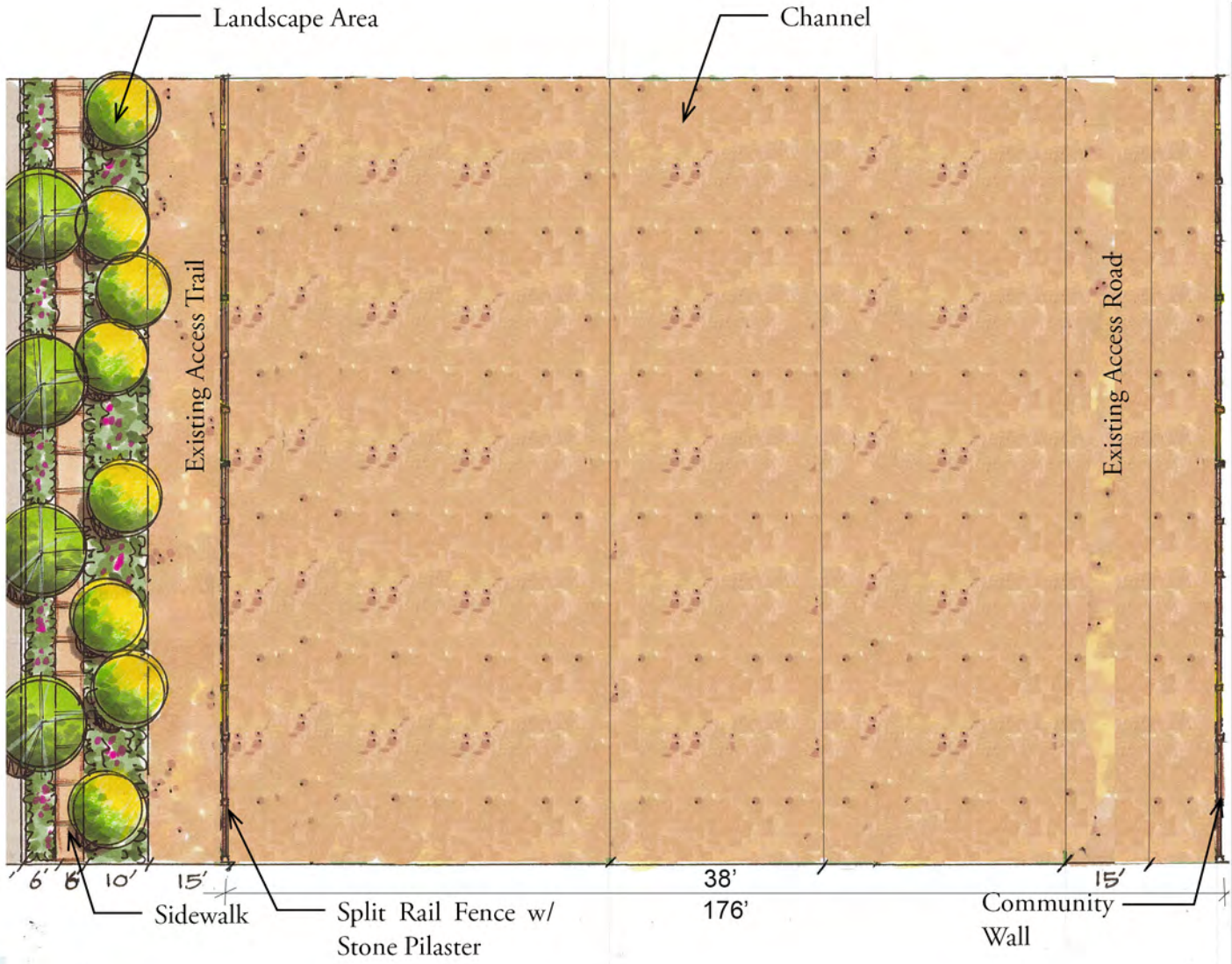


**Elevation & Section**

Not to Scale



SECTION I CHANNEL AT ETHANAC ROAD



Channel at Ethanac Road - Section

Not to Scale



FIGURE 4-38



**FIGURE 4-39**

Community Wall

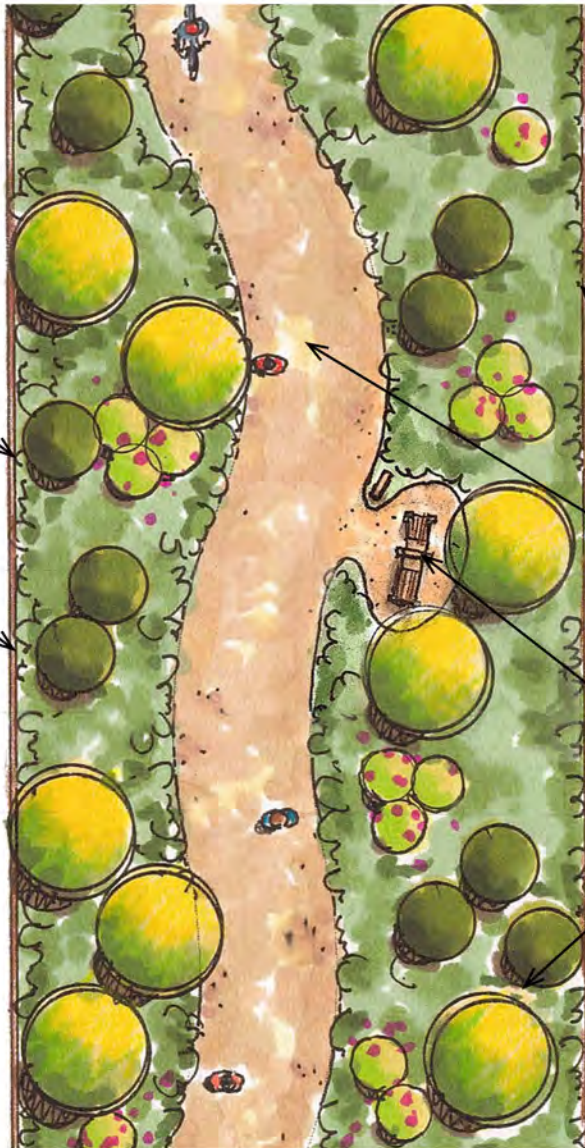
Landscape Area

Perimeter Community Wall

Multi Use Meandering Trail

Par Course Station

Landscape Area



Community Wall

Perimeter Community Wall



**EMWD Landscape Buffer - Section**

Not to Scale



**SECTION J EMWD LANDSCAPE BUFFER**



**4.4.7 Pedestrian Circulation and Trails**

The trail system will wind its way throughout the Green Valley development in several forms. A 6-foot-wide pedestrian sidewalk and a 6-foot-wide decomposed granite trail occur on either side of Green Valley Parkway, along Fieldstone Drive, and along Goetz Road. A 5’ wide pedestrian sidewalk occurs on both sides of Murrieta Road. A 15’ wide multi-use trail flanks the Romoland Channel on both sides. Another 15’ wide multi-use trail is located within the 60’ landscape buffer at the easterly edge of the project. Along the trail system within the landscape buffer, new technology par course/exercise stations will be intermittently located along the defined trail for circuit training and active exercise. This trail will contain gently undulating pathways and interesting plant material throughout the landscape treatment.

Figure 4-40 depicts the cross-section of the San Jacinto River Trail that will be located along the east side of the San Jacinto River. A Class I bike path will be provided, and an unpaved DG multi-purpose trail adjacent to the bike path will be provided where feasible.



Examples of Par Course Exercise Stations





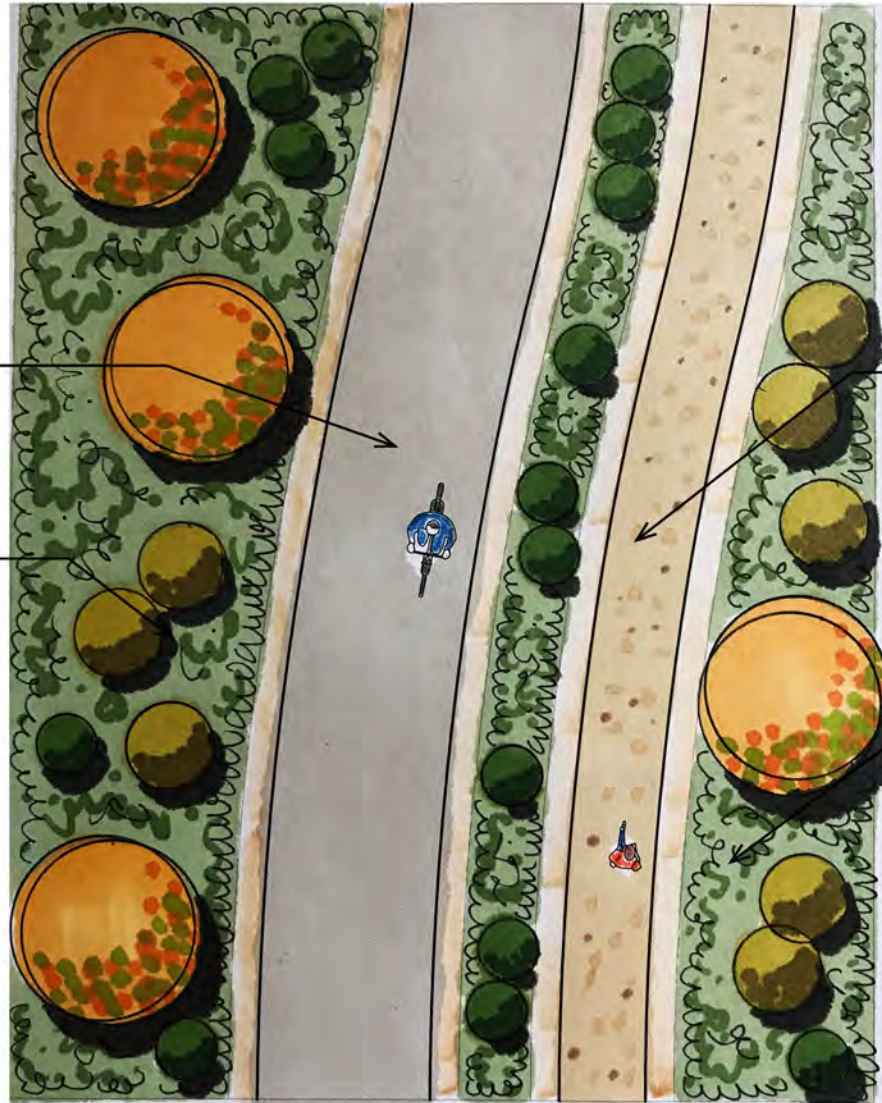
FIGURE 4-40

Class I Bikeway

Landscape Area

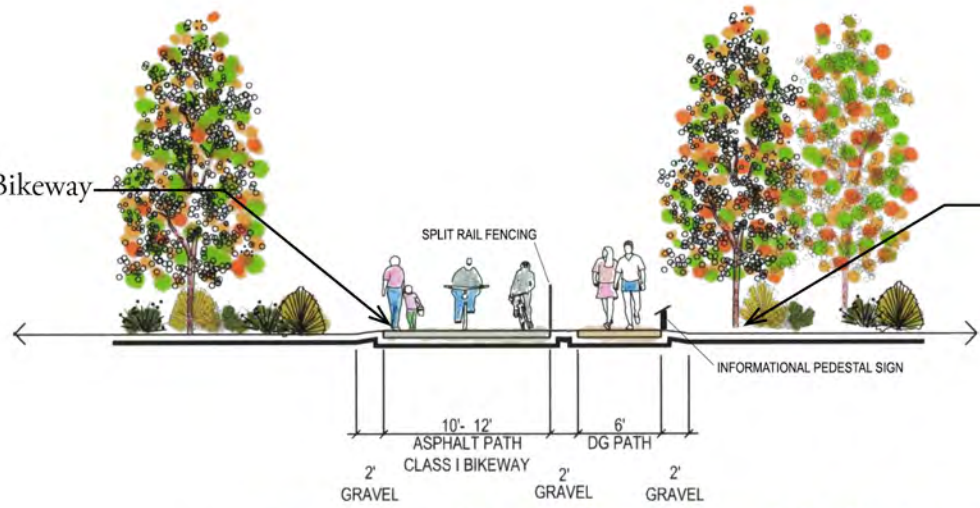
Decomposed Granite Path

Landscape Area



Class I Bikeway

Decomposed Granite Path



**K** San Jacinto River Bike Path and Trail - Section

Not to Scale



FIGURE 4-40A

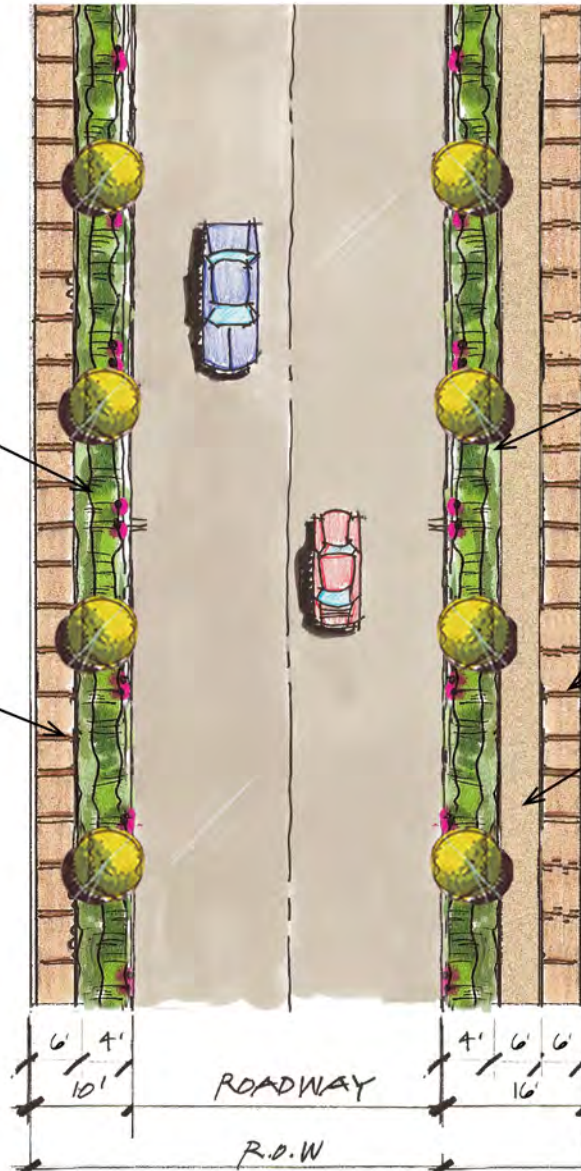
Landscape Area\* with layered shrubs and vines on the wall

Sidewalk

Landscape Area\* with layered shrubs and vines on the wall

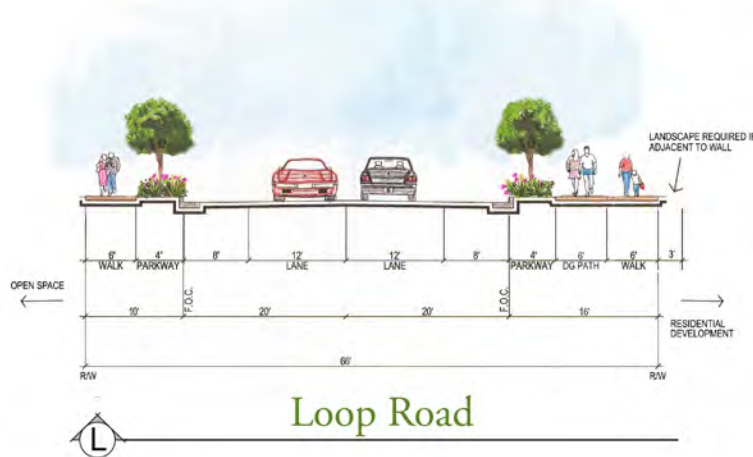
Sidewalk

Decomposed Granite Path



Note: Larger shrubs are to be used only when they will not require regular pruning.

\* Landscape area is 4'-0" wide. Refer to Plant Palette for **TREES** suitable for planting within a 4'-0" wide space.



Loop Road

Not to Scale





**4.4.8 Street Furniture Guidelines**

Site furnishings (required in all commercial areas) including, but not limited to, tables, benches, and trash receptacles will be wood, metal and/or concrete. The wood shall be stained to maintain a natural appearance. Images of custom and standard site furnishings have been provided as a basis of reference for design intent.

**Materials: (Custom)**

- Seat walls with stone and wood slats
- Varied paving materials, including stone, concrete, wood, decomposed granite, and concrete pavers.
- Wood Structures and picnic tables

**Materials: (Design Standards)**

- Trash receptacles with wood slats or steel slats. Steel Trash Receptacle shall be a Black or Dark Bronze color.
- Realistic wood, faux wood, or steel picnic tables, Benches with wood and metal accents, or all steel.
- Most shown are steel with rust proof coating and IPE hardwood or recycled plastic wood-like product.
- Mailboxes- powder coated steel, cluster box unit (CBU) with decorative lid. Decorative trellis required for all Cluster Box Unit Mailboxes.



Example of Seat Wall with Stone and Wood Slats



Example of Wood and Steel Bench



Example of Steel Bench



Example of Cluster Box Unit Mailboxes



Example of Trash Receptacle with Wood Slats and Steel





#### 4.4.9 Wall and Fence Guidelines

Maintaining quality and character of all aspects of the public realm is a key placemaking principle. The wall and fence design criteria are intended to provide variety and privacy for each lot while providing continuity and unity within the community.

Walls and fencing will be used throughout the community to complement the overall design theme, establish community identity, provide protection from roadway and other noise, and allow privacy and security in residential areas. The use of walls and fences can also serve to accentuate neighborhood features in addition to screening streets and adjacent uses.

The following types of walls (solid and opaque) and fences (open and largely transparent) have been selected for possible use within different areas of the project site. All wall and fence heights are measured from the highest grade elevation on either side of the wall or fence. An overall community wall program is provided to help unify and reinforce community character.

- All multi-family developments shall be gated to include a solid decorative block wall with pilasters every seventy-five (75) feet with decorative wrought iron gates to all access points.
- Decorative walls and/or screen walls shall be integrated with the architecture of community buildings, as well as the overall landscape design.
- All community theme walls and fences shall be consistent in design.
- For most products, the community wall will be colored split face block with a precision block cap. Pilasters will be a stone veneer with a precast colored concrete cap. Pilasters will occur at changes in wall direction or change in materials visible to the public realm.
- Walls adjoining a public street or any wall publicly visible or adjacent to the public realm shall be split face block with a precision block cap.
- Interior/side yard or any wall not visible to the public realm shall be precision block with precision cap, or vinyl fencing based on builder's preference and product price point.
- Use tubular steel view fence when fence is not visible from the Public Realm; i.e., from the major/primary external (perimeter) streets and internal streets. It can also be used at the drainage channel and park. No precision block wall shall be visible/exposed to the public realm; block wall will be used strictly for interior side yards.
- Vines and/or shrubs should be planted along community walls to soften the visual character. An extensive use of vines is encouraged.
- The maximum wall or fence height shall be six (6) feet within any required rear, or side setback area, and along the project perimeter unless a need for an 8'-0" high wall or higher is determined necessary to act as a "sound wall" and approved by the City. Wall/fence heights are measured from the base of the wall/ fence to the top of the interior or exterior side, always providing a minimum six (6) feet barrier from either side. The maximum height of any wall should not exceed ten (10) feet (in combination with a retaining wall) without a variance.
- Combination retaining wall and privacy walls at block ends may be used.
- Rear yard fencing adjacent to park areas or open space edges shall be view fencing, where applicable, considering grade differentials, etc.
- Where appropriate, view fencing may be less than 6' high to provide an enhanced view shed. In cases where pools or spas are located in rear yards, a minimum 5' high perimeter fence is required



per CA Code Section 115920. Continuous view fencing or block walls shall have pilasters located at corners, at changes in wall/fencing materials, and significant redirection in the fence line.

- Wall sections greater than 100' in length should incorporate at least one of the following design features which are proportionate to the wall length:
  - A minimum of two feet change in plane for at least two feet.
  - A minimum of 18-inch change in height for at least ten feet.
  - Use of pilasters at regular intervals of approximately 100' at changes in wall planes, wall materials, and at wall terminus.
  - A minimum of four feet high view fencing section for at least ten feet.
- Solid decorative block walls are required for property line fencing and gate returns between housing lots and those areas in public view. Fence returns located on the garage side of each home shall include a three-foot (3') wide minimum gate (vinyl or other durable material).
- All retaining walls, courtyard walls, gates, and fences shall be compatible with the architecture of each neighborhood/ district.
- Precision block walls are prohibited from being visible from public view (trail, open channel, street, etc.).
- For residential side yard gates, vinyl gates with split face block walls are required; color to match and complement adjacent wall or architecture.
- Gates should be provided in walls or fences to allow emergency access and to facilitate convenient pedestrian access to activity areas and adjacent uses.
- Walls should be eliminated or sited to provide additional setback areas at project entries to accommodate distinctive landscaping, ornamental gateways, signage, and street furniture.
- Wall should be curved or angled at corner locations along street frontages to preserve sight lines.
- Sight lines shall be taken into account when laying out lots and perimeter walls.
- For any retaining walls along the right of way, a cross section will be provided and included on the conceptual fencing plan.
- Wood fencing is not permitted.
- Fencing for any proposed bioswales or detention basins shall be tubular steel (to resemble wrought iron) with pilasters spaced at approximately 50 feet apart.
- All wall and fence areas accessible to the public shall be treated with "graffiti" resistant coating.

Figure 4-41 depicts the Green Valley Wall and Fence Plan, and Figure 4-42 depicts the Phase I Wall and Fence Plan.



# WALL AND FENCING PLAN



FIGURE 4-41

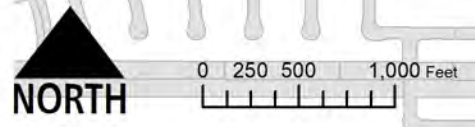
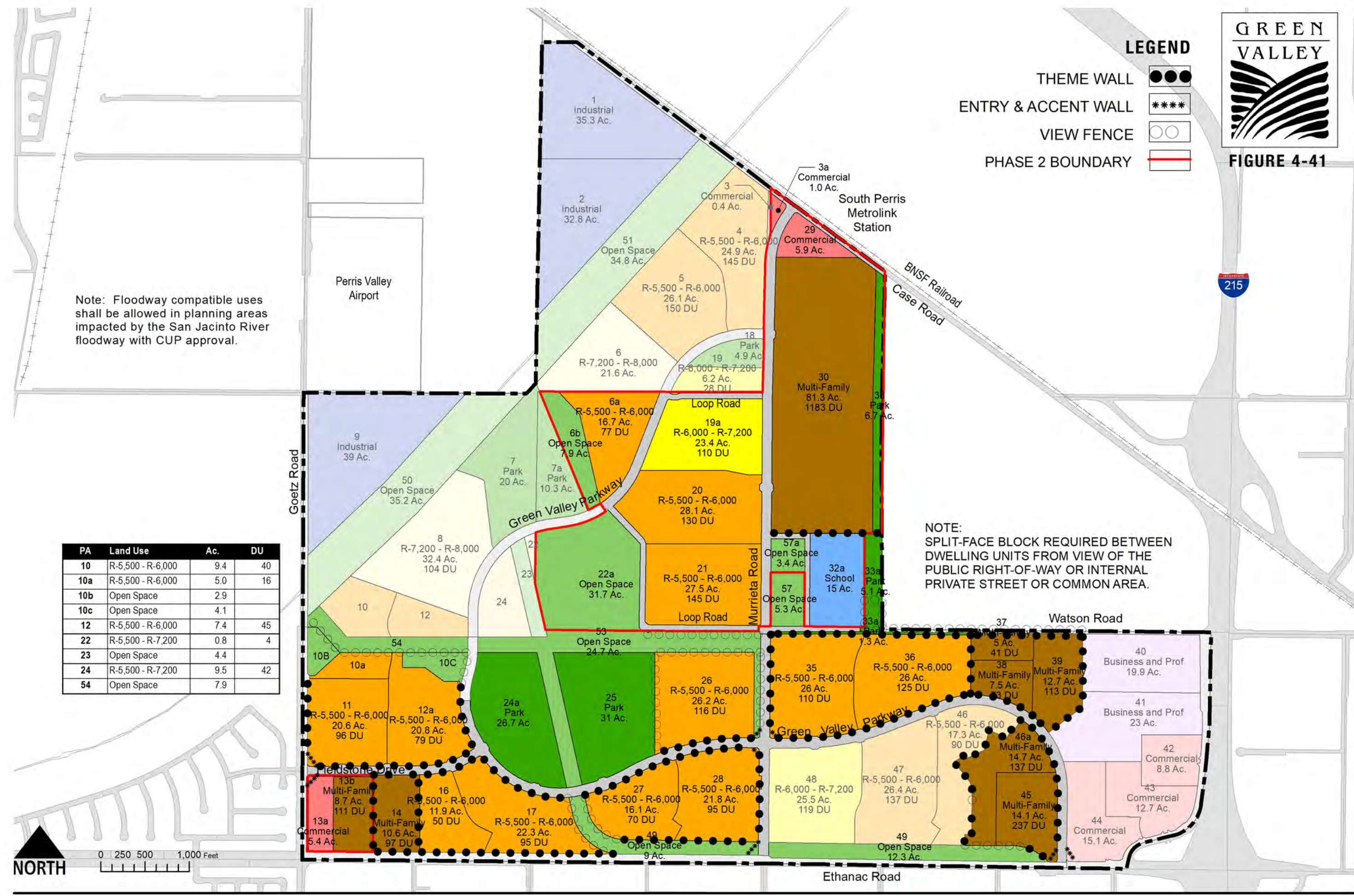
### LEGEND

- THEME WALL ●●●●
- ENTRY & ACCENT WALL \*\*\*\*
- VIEW FENCE ○○
- PHASE 2 BOUNDARY —

Note: Floodway compatible uses shall be allowed in planning areas impacted by the San Jacinto River floodway with CUP approval.

NOTE: SPLIT-FACE BLOCK REQUIRED BETWEEN DWELLING UNITS FROM VIEW OF THE PUBLIC RIGHT-OF-WAY OR INTERNAL PRIVATE STREET OR COMMON AREA.

PA	Land Use	Ac.	DU
10	R-5,500 - R-6,000	9.4	40
10a	R-5,500 - R-6,000	5.0	16
10b	Open Space	2.9	
10c	Open Space	4.1	
12	R-5,500 - R-6,000	7.4	45
22	R-5,500 - R-7,200	0.8	4
23	Open Space	4.4	
24	R-5,500 - R-7,200	9.5	42
54	Open Space	7.9	



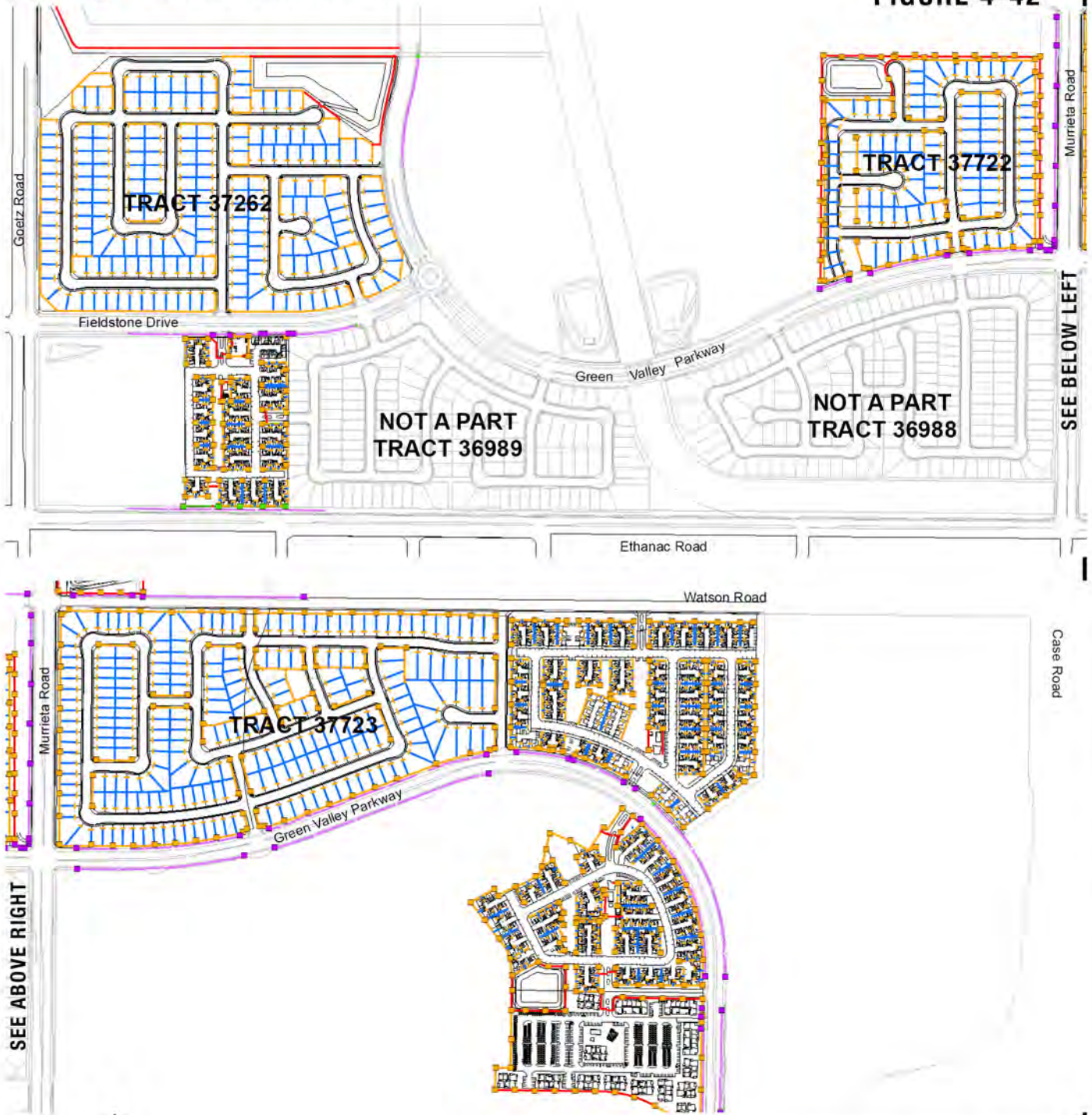


# WALL & FENCE PLAN PHASE 1



**FIGURE 4-42**

- █ 8' Community Block Wall (Ethanac Rd)
- █ 6' High Community Block Wall
- █ 6' High Tubular Steel Fence
- █ 6' High Interior Vinyl Fence
- █ 3'-6" High Trail Fence
- █ 8'-6" Stone Veneer Pilaster (Ethanac Rd)
- █ 6'-6" Stone Veneer Trail Pilaster
- █ 3'-6" Stone Veneer Trail Pilaster

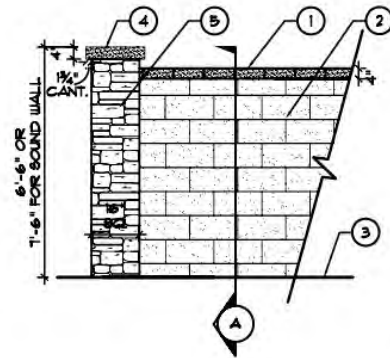


Not to Scale

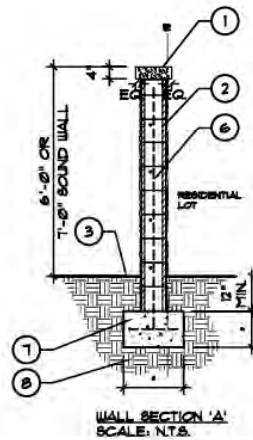
**NOTE:**  
SPLIT-FACE BLOCK REQUIRED BETWEEN DWELLING UNITS FROM VIEW OF THE PUBLIC RIGHT-OF-WAY OR INTERNAL PRIVATE STREET OR COMMON AREA.

4. Design Guidelines

The following photos should not be construed as the exact wall and fence height, color and material, but should be used as preferred examples. The sketches and graphic representations contained within these Design Guidelines are for conceptual purposes and are provided as visual aids in understanding the basic intent of the Guidelines and to present examples of their potential implementation. The block/color specification can be substituted with a different manufacturer as long as colors and textures match.

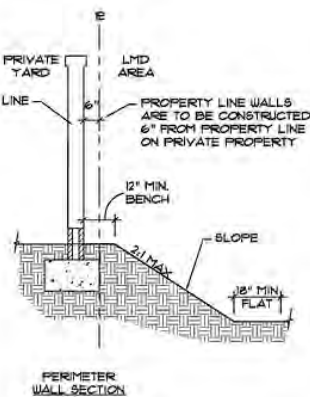
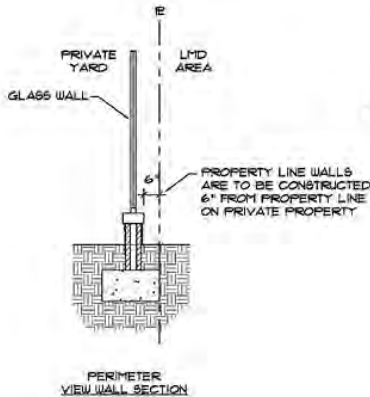


Community Wall and Pilaster (Solid Fence)	
Pilaster Veneer:	60% Italian Villa, color: Verona 40% Tuscan Villa, color: Florentine Manufacturer: Coronado Stone
Stone Grout:	New Taupe #185 - Custom Bldg. Prod.
Wall:	Split face block wall-Angelus Block
Wall Color:	Harvest - Angelus Block
Pilaster & Wall Cap Color:	Harvest -Angelus Block
Pilaster Cap:	Precision Pilaster Cap - Angelus Block
Wall Cap:	Precision Wall Cap - Angelus Block
Grout:	Summer Wheat #45-Custom Building Products



- ① PRECISION WALL CAP
- ② 6X6X16 SPLIT FACE BLOCK  
GROUT ALL CELLS SOLID.
- ③ FINISH GRADE
- ④ PRECISION PILASTER CAP.
- ⑤ 16X6X16 SQ. COLUMN WITH STONE VENEER
- ⑥ REINFORCEMENT PER STRUCTURAL ENGINEER PLANS
- ⑦ CONCRETE FOOTING - PER STRUCTURAL ENGINEER PLANS
- ⑧ COMPACTED SUBGRADE PER GEOTECHNICAL REPORT

NOTE:  
1. GROUT TO MATCH BLOCK COLOR  
2. MASONRY AND COLORS AVAILABLE THRU ANGELUS BLOCK OR EQUIVALENT



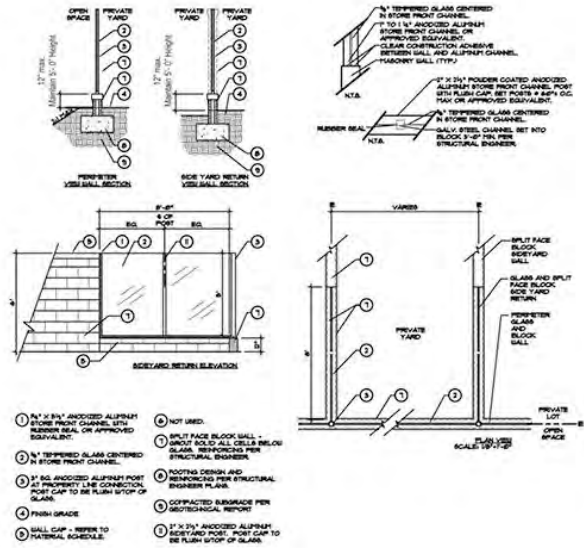
NOTE:  
IT IS THE INTENT THAT ALL PERIMETER AND PROPERTY LINE WALLS ABUTTING LMD AREAS ARE TO BE LOCATED ON PRIVATE PROPERTY AND MAINTAINED BY THE PROPERTY OWNER.





**Community Glass View Fence**

Metal Color:	Spraylac Regal Brown
Pilaster Veneer:	60% Italian Villa, color: Verona 40% Tuscan Villa, color: Florentine
Stone Grout:	New Taupe # 185-Custom Bldg. Prod.
Low-Wall:	Split face block wall-Angelus Block
Wall Color:	Harvest - Angelus Block
Pilaster & Wall Cap Color:	Harvest - Angelus Block
Pilaster Cap:	Precision Pilaster Cap
Wall Cap:	Precision Wall Cap
Grout:	Summer Wheat #45-Custom Building Products



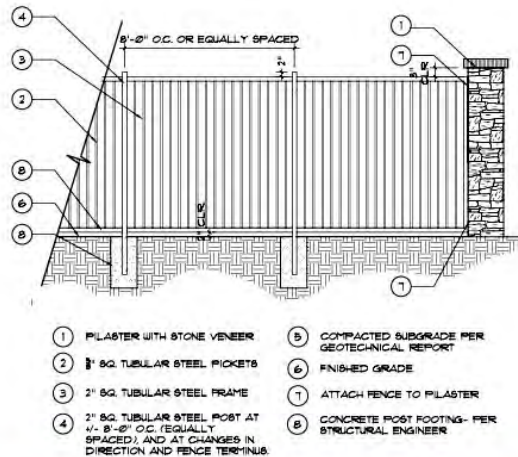
Use when glass view fence is visible from the Public Realm from the major/primary external (perimeter) streets and internal streets.



**Community Prefabricated Tubular Steel View Fence**

Metal Color:	Powder Coated- Sherwin Williams SW7020 Black Fox *All Fencing connections are to be field welded and painted.
--------------	---

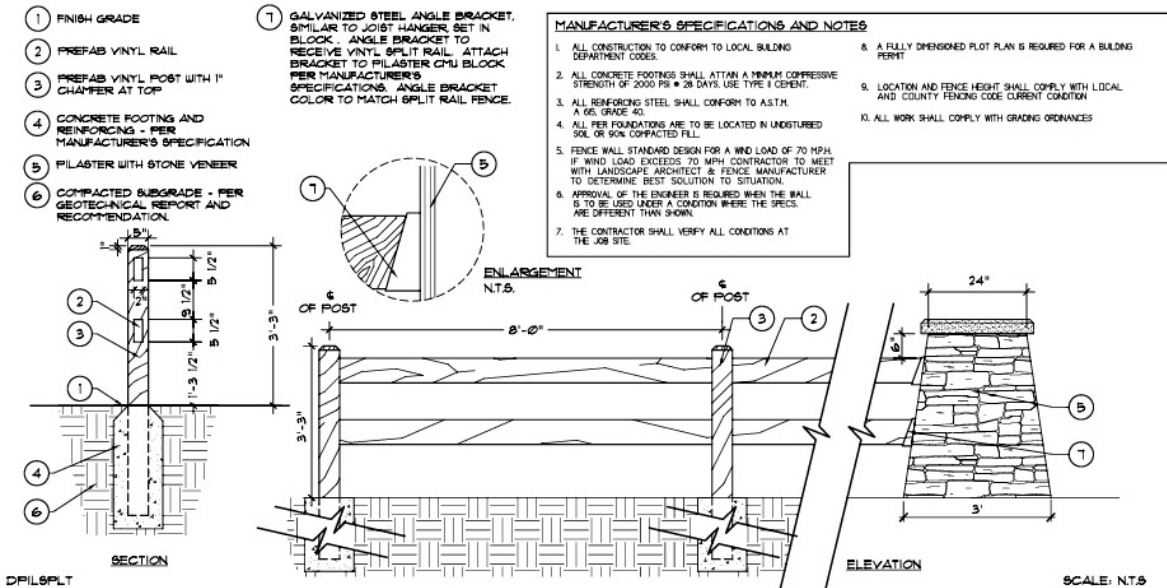
Use when tubular view fence is not visible from the Public Realm from the major/primary external (perimeter) streets and internal streets. Can be used at drainage channel and park with exception as noted. Refer to Wall & Fence Plan herein.



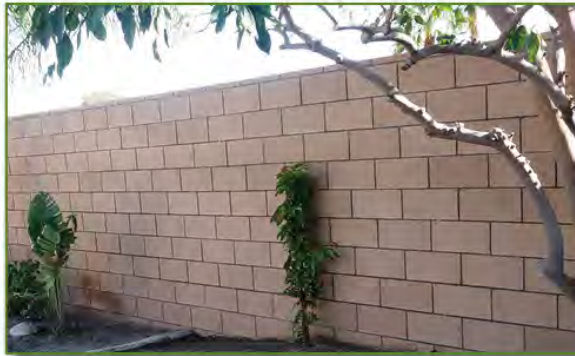




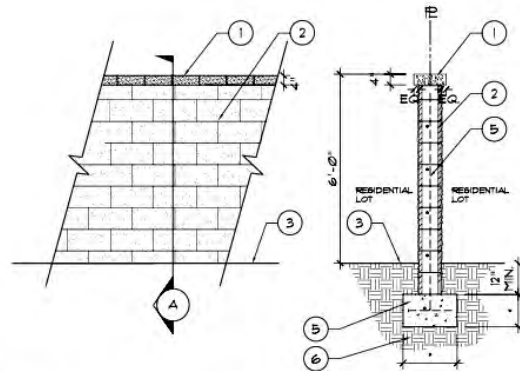
Split Rail Fence with Stone Pilasters	
Fence:	Wood Grain Vinyl Split Rail, color: Natural Gray
Pilaster Stone Veneer:	60% Italian Villa, color: Verona 40% Tuscan Villa, color: Florentine Manufacturer: Coronado Stone
Stone Grout:	New Taupe #185-Custom Bldg. Prod.



4. Design Guidelines



<b>Precision Block Wall Option at Side Yard Conditions</b> (No Precision Block Wall shall be visible/exposed to the public realm. Strictly for interior sideyards only.)	
Wall:	Precision Block wall and Precision Block cap through Angelus Block
Wall and Cap Color:	Harvest-Angelus Block
Grout:	Summer Wheat #45-Custom Building Products



- ① PRECISION BLOCK WALL CAP
  - ② 6x8x16 PRECISION BLOCK, GROUT ALL CELLS SOLID.
  - ③ FINISH GRADE
  - ④ REINFORCEMENT PER STRUCTURAL ENGINEER PLANS
  - ⑤ CONCRETE FOOTING - PER STRUCTURAL ENGINEER PLANS
  - ⑥ COMPACTED SUBGRADE PER GEOTECHNICAL REPORT
- NOTE:  
1. GROUT TO MATCH BLOCK COLOR  
2. MASONRY AND COLORS AVAILABLE THRU ANGELUS BLOCK OR EQUIVALENT



<b>Vinyl Gate Option at Side Yard Conditions</b>	
Color:	Natural Cedar - available through Kroy Vinyl Fencing

Gate shown for material only

<b>Vinyl Fence Option at Side Yard Conditions</b>	
Color:	Natural Cedar - available through Kroy Vinyl Fencing



**4.4.10 Utility and Equipment Screening**

All utilities above/below ground and other equipment providing service to the Green Valley residential neighborhoods and the commercial and mixed-use areas shall be screened accordingly to prevent unsightly conditions that distract from the overall aesthetics.

- Above-ground utility equipment should be screened from view by the use of hedges, trees, or larger screening plant material and or vines where feasible, subject to utility provider requirements or restrictions.
- Above-ground utility equipment, vents, and access doors to underground utilities shall be located with sufficient space to allow clearance between the screening for the utility equipment and any paved surface including streets, driveways, and walkways.



**4.4.11 Landscape Irrigation Note**

All landscaped areas will be permanently irrigated using an automatic, underground irrigation system or drip system. The irrigation system will be separated into several systems based on water requirements of each hydrozone. Hydrozone separations will be based on sun orientation and water requirements of the plant material.

Irrigation of required landscaped areas shall be by either automatic overhead high efficiency spray nozzle or drip irrigation and matched precipitation rate, low-gallon sprinkler heads, bubblers, and timing devices. Landscape areas less than 8’ wide shall be irrigated with drip irrigation. Timing devices shall include soil moisture sensors and rain sensing override devices. Sprinkler pop- up heights shall range from 6” high in turf areas and 12” high in shrub/groundcover beds where a drip system may not be applicable. The irrigation system shall be capable of operating automatically by incorporating an electric weather-based and climate-smart irrigation controller or advanced solar technology components and low voltage electric remote control valves. Quick coupling valves, as required, shall be strategically located to provide supplemental water to plant material and for wash down purposes. All remote control and quick coupling valves shall be located and installed within the shrub beds wherever possible.



The irrigation system will be compliant with the City Water Efficient Ordinance and the most current version of AB 1881 or current new ordinances, the State Model Water Efficient Landscape Ordinance. Irrigation water use will comply with water allotments defined in the Ordinance.





A backbone “purple pipe” non -potable water system shall be designed and installed to supply non-potable water to park sites, landscape corridors, natural parkways, and other public landscaped areas within the community.

**4.4.12 Landscape Master Community Plant Matrix**

The plant list for this project was developed to reinforce the community theme and to create some seasonal change with a mixture of low water use, drought-tolerant, deciduous, and evergreen plants while maintaining a well-balanced landscape. Many plants on this list are considered low water using, are drought-tolerant species, and were chosen based on their specific growth characteristics, including flowering and foliage color, texture and form.

The following items should be considered in the community landscape design process:

- Consistent street tree themes should be related to the hierarchy of the street system.
- Street trees are required to be spaced a maximum of 30’ on center and shall be minimum 24” box size.
- Extensive use of trees, vines and shrubs to soften community theme wall and fencing.
- Recognition of existing natural conditions and situations.
- Use of both “formal” and “informal” planting arrangements, depending upon the particular condition.
- Layering of the shrub understory to create depth, variety and interest.
- Refer to local codes for spacing distance from utilities, light poles, etc.
- All slopes shall be indicated on the tract map, including slope ratio.
- The maximum slope area within the public right of way is 3:1.
- All slopes three (3) feet or higher anywhere on the site are required to be landscaped, and slope cross sections shall be included on the conceptual landscape plans.
- Trees planted in 3’-6” wide parkways and 4’-0” wide landscape areas shall be selected with careful consideration for growth habit, canopy spread, and mature tree size.



**LANDSCAPE MASTER COMMUNITY PLANT MATRIX**

\*Indicates drought-tolerant or low-water use species

\*\*Indicates that designer must select a low water or drought-tolerant variety only

<sup>1</sup> Indicates Tree Species appropriate for 3'-6" min. width parkway or 4'-0" min. width landscape area

<b>Botanical Name</b>	<b>Common Name</b>	<b>Project Entries</b>	<b>Signature Corridors: Green Valley Parkway Fieldstone Drive Murieta Road Goetz Road</b>	<b>Perris Approved Street Tree List</b>	<b>Single Family Detached &amp; Multi-Family Private Yards/In-tract Parkway</b>	<b>Multi-Family Common Areas</b>	<b>Parks/Schools</b>	<b>Open Space</b>	<b>Commercial/Mixed Used</b>	<b>Drainage Basin</b>	<b>Slopes</b>
<b>TREES</b>											
<i>Abies concolor</i>	White Fir			•	•						
<i>Abies koreana</i>	Korean Fir				•						
<i>Abies pinsapo</i>	Spanish Fir				•						
<i>Acacia spp.*</i>	Acacia	•	•		•	•	•		•		
<i>Acacia aneura *</i>	Mulga			•	•						
<i>Acacia baileyana *</i>	Bailey Acacia				•						
<i>Acacia farnesiana *</i>	Sweet Acacia			•	•	•					
<i>Acacia salicina *</i>	Willow Acacia			•	•	•					
<i>Acacia stenophylla *</i>	Shoestring Acacia			•	•	•					
<i>Acer spp.</i>	Maple				•	•			•		•
<i>Aesculus californica *</i>	California Buckeye			•	•			•			•
<i>Albizia distachya</i>	Plume Albizia				•						
<i>Albizia julibrissin *</i>	Silk Tree	•	•	•	•	•	•		•		
<i>Alnus cordata</i>	Italian Alder				•					•	
<i>Alnus glutinosa</i>	European Alder				•					•	
<i>Alnus rhombifolia</i>	White Alder				•					•	
<i>Araucaria araucana</i>	Monkey Puzzle Tree				•			•			
<i>Araucaria bidwillii</i>	Bunya-Bunya				•						
<i>Arbutus andrachne *</i>	Arbutus	•	•		•	•		•	•		
<i>Arbutus menziesii</i>	Madrone	•	•		•	•	•	•	•		•
<i>Arbutus unedo *</i>	Strawberry Tree	•	•	•	•	•	•	•	•		•
<i>Arbutus unedo 'Marina'</i>	Marina Strawberry Tree	•	•		•	•	•	•	•		•
<i>Bauhinia forficata</i>	Brazilian Butterfly Tree			•	•	•					
<i>Bauhinia lunariodes *</i>	Anacacho Orchid Tree				•	•					
<i>Bauhinia mexicana</i>	White Orchid Tree	•	•		•	•					
<i>Bauhinia purpurea</i>	Purple Orchid Tree	•	•	•	•	•			•		
<i>Betula nigra</i>	River Birch	•	•		•		•		•	•	•
<i>Betula pendula</i>	White Birch	•	•		•		•		•	•	•
<i>Brachychiton acerifolius</i>	Flame Tree	•	•		•	•	•		•		
<i>Brachychiton populneus *</i>	Bottle Tree	•	•	•	•	•	•		•		•
<i>Brachychiton x Majestic Beauty</i>	Majestic Beauty Flame Tree	•	•		•	•	•		•		•



LANDSCAPE MASTER COMMUNITY PLANT MATRIX

\*Indicates drought-tolerant or low-water use species

\*\*Indicates that designer must select a low water or drought-tolerant variety only

<sup>1</sup> Indicates Tree Species appropriate for 3'-6" min. width parkway or 4'-0" min. width landscape area

Botanical Name	Common Name	Project Entries	Signature Corridors: Green Valley Parkway Fieldstone Drive Murieta Road Goetz Road	Perris Approved Street Tree List	Single Family Detached & Multi-Family Private Yards/In-tract Parkway	Multi-Family Common Areas	Parks/Schools	Open Space	Commercial/Mixed Used	Drainage Basin	Slopes
<i>Callistemon citrinus</i> *	Lemon Bottlebrush			●	●						
<i>Callistemon viminalis</i>	Weeping Bottlebrush			●	●						
<i>Calocedrus decurrens</i>	Incense Cedar			●	●						
<i>Carya illinoensis</i>	Pecan				●						
<i>Castanospermum australe</i>	Moreton Bay Chestnut				●						
<i>Casuarina cunninghamiana</i> *	River She-Oak				●						
<i>Casuarina equisetifolia</i>	Horsetail Tree				●						
<i>Casuarina stricta</i> *	Mountain She-Oak				●						
<i>Castanea dentate</i>	American Chestnut				●						
<i>Castanea mollissima</i>	Chinese Chestnut				●						
<i>Catalpa speciosa</i>	Western Catalpa				●			●			●
<i>Cedrus spp.</i>	Cedar	●	●		●		●		●		
<i>Cedrus atlantica</i> ('Glauca')	Atlas (Blue) Cedar	●	●		●		●		●		
<i>Cedrus deodara</i>	Deodar Cedar	●	●	●	●		●	●	●		●
<i>Celtis occidentalis</i>	Common Hackberry				●						
<i>Ceratonia siliqua</i> *	Carob Tree	●	●		●	●	●		●		●
<i>Cercidium 'Desert Museum'</i> *	Desert Museum Palo Verde	●	●		●	●	●	●	●		●
<i>Cercidium floridum</i> *	Blue Palo Verde	●	●	●	●	●	●	●	●		●
<i>Cercidium microphyllum</i> *	Little Leaf Palo Verde			●	●			●			●
<i>Cercidium praecox</i> *	Sonoran Palo Verde			●	●			●			●
<i>Cercis canadensis</i>	Eastern Redbud				●	●	●		●	●	●
<i>Cercis canadensis</i> 'Forest Pansy'	Forest Pansy Redbud				●	●	●		●	●	●
<i>Cercis occidentalis</i> *	Western Redbud	●	●	●	●	●	●	●	●	●	●
<i>Chilopsis linearis</i> *	Desert Willow	●	●	●	●	●	●	●	●	●	●
<i>Chilopsis linearis</i> 'Burgundy Lace' *	Burgundy Desert Willow	●	●	●	●	●	●	●	●	●	●
<i>Chilopsis linearis</i> 'Lucretia Hamilton' *	Lucretia Hamilton Desert Willow	●	●	●	●	●	●	●	●	●	●
<i>Chilopsis linearis</i> 'Warren Jones'*	Warren Jones Desert Willow	●	●		●	●	●	●	●	●	●
<i>Chionanthus retusus</i> <sup>1</sup>	Chinese Fringe Tree	●	●		●	●	●		●		
<i>Chitalpa tashkentensis</i> * <sup>1</sup>	Chitalpa			●	●						●
<i>Chitalpa tashkentensis</i> 'Pink Dawn' * <sup>1</sup>	Pink Dawn Chitalpa				●			●			●





LANDSCAPE MASTER COMMUNITY PLANT MATRIX

\*Indicates drought-tolerant or low-water use species

\*\*Indicates that designer must select a low water or drought-tolerant variety only

<sup>1</sup> Indicates Tree Species appropriate for 3'-6" min. width parkway or 4'-0" min. width landscape area

Botanical Name	Common Name	Project Entries	Signature Corridors: Green Valley Parkway Fieldstone Drive Murieta Road Goetz Road	Perris Approved Street Tree List	Single Family Detached & Multi-Family Private Yards/In-tract Parkway	Multi-Family Common Areas	Parks/Schools	Open Space	Commercial/Mixed Used	Drainage Basin	Slopes
<i>Chorisia speciosa</i> *	Floss Silk Tree	●	●	●	●	●		●	●		
<i>Cinnamomum camphora</i>	Camphor Tree	●	●	●	●	●	●		●		
<i>Citrus spp.</i>	Citrus	●	●		●	●	●		●		
<i>Cocculus laurifolius</i>	Laurel Leaf Snail Seed				●						
<i>Cordia boissieri</i> *	Texas Olive				●						
<i>Cordyline australis</i>	Dracaena	●	●		●	●	●		●		
<i>Cornus alba</i> 'Argento Marginata'	Variiegated Dogwood				●					●	
<i>Cotinus coggyria</i> *	Smoke Tree			●	●						
<i>Cryptomeria japonica</i>	Japanese Cryptomeria				●						
<i>Cupaniopsis anacardioides</i>	Carrot Wood	●	●	●	●	●	●		●		
<i>Cupressocyparis leylandii</i>	Leyland Cypress				●	●					
<i>Cupressus spp.</i>	Cypress	●	●		●	●	●		●		
<i>Cupressus arizonica</i> *	Arizona Cypress				●	●					
<i>Cupressus sempervirens</i> *	Italian Cypress	●	●	●	●	●	●		●		
<i>Dalbergia sissoo</i> *	Sissoo Tree			●	●						
<i>Diospyros kaki</i>	Fuyu Persimmon				●						
<i>Diospyros virginiana</i>	American Persimmon				●						●
<i>Elaeocarpus decipiens</i>	Japanese Blueberry Tree	●	●	●	●	●	●	●	●	●	●
<i>Eriobotrya deflexa</i> <sup>1</sup>	Bronze Loquat	●	●	●	●	●	●	●	●	●	●
<i>Eriobotrya japonica</i>	Loquat	●	●		●	●	●	●	●	●	●
<i>Erythryna x bidwillii</i>	Coral Tree	●	●	●	●	●	●		●		
<i>Eucalyptus spp.</i> ** (Exclude all invasive species or those species susceptible to Thrips)	Gum	●	●	●	●	●	●	●	●	●	●
<i>Eucalyptus citriodora</i>	Lemon Scented Gum			●							
<i>Eucalyptus microtheca</i> *	Coolibah Tree			●							
<i>Eucalyptus papuana</i> *	Ghost Gum			●							
<i>Eucalyptus polyanthemos</i> *	Silver Dollar Gum			●							
<i>Eucalyptus torquata</i>	Coral Gum			●							
<i>Fagus grandifolia</i>	American Beech				●						
<i>Fagus sylvatica</i>	European Beech				●						
<i>Fagus sylvatica</i> 'Atropunicea'	Copper Beech				●						
<i>Fagus sylvatica</i> 'Pendula'	Weeping European Beech				●						



LANDSCAPE MASTER COMMUNITY PLANT MATRIX

\*Indicates drought-tolerant or low-water use species

\*\*Indicates that designer must select a low water or drought-tolerant variety only

<sup>1</sup>Indicates Tree Species appropriate for 3'-6" min. width parkway or 4'-0" min. width landscape area

Botanical Name	Common Name	Project Entries	Signature Corridors: Green Valley Parkway Fieldstone Drive Murieta Road Goetz Road	Perris Approved Street Tree List	Single Family Detached & Multi-Family Private Yards/In-tract Parkway	Multi-Family Common Areas	Parks/Schools	Open Space	Commercial/Mixed Used	Drainage Basin	Slopes
<i>Fagus sylvatica</i> 'Purpurea Pendula'	Weeping Purple Beech				•						
<i>Feijoa sellowiana</i>	Pineapple Guava	•	•		•	•	•		•		•
<i>Ficus microcarpa</i>	Indian Laurel Fig	•	•	•	•	•	•		•		
<i>Ficus rubiginosa</i>	Rustyleaf Fig	•	•		•	•	•		•		
<i>Ficus rubiginosa</i> 'Florida'	Florida Rustyleaf Fig	•	•		•	•	•		•		
<i>Firmiana simplex</i>	Parasol Tree				•						
<i>Forestiera neomexicana</i>	New Mexican Privet				•						•
<i>Fraxinus spp.</i>	Ash	•	•		•	•	•	•	•		•
<i>Fraxinus angustifolia</i> 'Raywood'	Raywood Ash	•	•		•	•	•	•	•		•
<i>Fraxinus greggii</i>	Little Leaf Ash	•	•	•	•	•	•	•	•		
<i>Fraxinus uhdei</i>	Shamel Ash	•	•	•	•	•	•	•	•		
<i>Fraxinus velutina</i>	Arizona Ash	•	•	•	•	•	•	•	•		•
<i>Fraxinus velutina</i> 'Modesto's	Modesto Ash	•	•		•	•	•	•	•		•
<i>Garrya elliptica</i>	Coast Silk Tassel				•						
<i>Geijera parviflora</i>	Australian Willow	•	•	•	•	•			•		•
<i>Ginkgo biloba</i>	Ginkgo, Maidenhair Tree	•	•	•	•	•	•		•		•
<i>Ginkgo biloba</i> 'Autumn Gold'	Autumn Gold Maidenhair Tree	•	•		•	•	•		•		•
<i>Ginkgo biloba</i> 'Saratoga'	Saratoga Maidenhair Tree	•	•		•	•	•		•		
<i>Gleditsia triacanthos</i> *	Honey Locust			•	•	•		•			
<i>Gleditsia triacanthos</i> 'Shademaster' *	Shademaster Locust				•	•		•			
<i>Gleditsia trachanthos</i> 'Sunburst'*	Sunburst Locust				•	•		•			
<i>Grevillea robusta</i> *	Silk Oak				•	•		•			
<i>Hakea laurina</i> *	Sea Urchin Hakea				•	•					
<i>Halesia carolina</i>	Carolina Silver Bell				•						
<i>Halesia monticolae</i>	Mountain Silver Bell				•						
<i>Heteromeles arbutifolia</i> *	Toyon	•	•		•	•	•	•	•	•	•
<i>Hymenosporum flavum</i> <sup>1</sup>	Sweetshade	•	•		•	•	•		•	•	
<i>Ilex x 'Nellie R. Stevens'</i>	Nellie Stevens Holly				•						
<i>Ilex x altaclarensis</i> 'Wilsonii'	Wilson Altaclara Holly				•						
<i>Ilex aquifolium</i>	English Holly				•						



LANDSCAPE MASTER COMMUNITY PLANT MATRIX

\*Indicates drought-tolerant or low-water use species

\*\*Indicates that designer must select a low water or drought-tolerant variety only

<sup>1</sup> Indicates Tree Species appropriate for 3'-6" min. width parkway or 4'-0" min. width landscape area

Botanical Name	Common Name	Project Entries	Signature Corridors: Green Valley Parkway Fieldstone Drive Murrleta Road Goetz Road	Perris Approved Street Tree List	Single Family Detached & Multi-Family Private Yards/In-tract Parkway	Multi-Family Common Areas	Parks/Schools	Open Space	Commercial/Mixed Used	Drainage Basin	Slopes
<i>Ilex cornuta 'Burfordii'</i>	Burford Chinese Holly				•						
<i>Jacaranda mimosifolia</i>	Jacaranda	•	•	•	•	•	•		•		
<i>Juglans californica</i> *	California Black Walnut			•	•			•			
<i>Juglans regia</i>	English Walnut				•						
<i>Juniperus californica</i>	California Juniper			•	•	•	•		•		
<i>Juniperus conferta</i>	Shore Juniper				•	•	•		•		
<i>Juniperus occidentalis</i>	Western Juniper				•	•	•		•		
<i>Juniperus scopulorum</i>	Rocky Mountain Juniper	•	•	•	•	•	•		•		•
<i>Juniperus scopulorum 'Blue Haven'</i>	Blue Haven Juniper	•	•		•	•	•		•		•
<i>Juniperus scopulorum 'Skyrocket'</i>	Skyrocket Juniper	•	•		•	•	•		•		•
<i>Koelreuteria bipinnata</i>	Chinese Flame Tree	•	•	•	•	•	•	•	•		
<i>Koelreuteria paniculata</i> *	Goldenrain Tree	•	•	•	•	•	•	•	•		•
<i>Lagerstroemia spp.</i> <sup>1</sup>	Crape Myrtle	•	•	•	•	•	•	•	•		•
<i>Lagerstroemia hybrid 'Arapaho'</i> <sup>1</sup>	Arapaho Crape Myrtle	•	•		•	•	•	•	•		•
<i>Lagerstroemia hybrid 'Muskogee'</i> <sup>1</sup>	Muskogee Crape Myrtle	•	•		•	•	•	•	•		•
<i>Lagerstroemia hybrid 'Natchez'</i> <sup>1</sup>	Natchez Crape Myrtle	•	•		•	•	•	•	•		•
<i>Lagerstroemia hybrid 'Tonto'</i> <sup>1</sup>	Tonto Crape Myrtle	•	•		•	•	•	•	•		•
<i>Lagerstroemia hybrid 'Tuscarora'</i> <sup>1</sup>	Tuscarora Crape Myrtle	•	•		•	•	•	•	•		•
<i>Lagunaria patersonii</i>	Primrose Tree			•	•		•		•		
<i>Laurus nobilis</i> *	Sweet Bay	•	•	•	•	•	•		•		
<i>Leptospermum laevigatum</i> *	Australian Tea Tree	•	•		•	•	•		•		
<i>Liquidambar styraciflua (seedless var.)</i>	Sweet Gum	•	•	•	•	•	•	•	•		•
<i>Liriodendron tulipifera</i>	Tulip Tree	•	•		•	•	•		•		
<i>Lithocarpus densiflorus</i> *	Tanbark Oak			•	•						
<i>Luma apiculata</i>	Luma				•						
<i>Lyonthalmus floribundus asplenifolius</i> *	Catalina Ironwood				•			•			•
<i>Lysiloma microphylla thornberi</i> *	Feather Bush			•	•						
<i>Magnolia spp.</i>	Magnolia	•	•		•	•	•	•	•		
<i>Magnolia grandiflora</i>	Southern Magnolia	•	•	•	•	•	•		•		
<i>Magnolia grandiflora 'St. Mary'</i>	St. Mary Southern Magnolia	•	•		•	•	•		•		
<i>Magnolia x soulangeana</i>	Saucer Magnolia	•	•		•	•	•		•		





LANDSCAPE MASTER COMMUNITY PLANT MATRIX

\*Indicates drought-tolerant or low-water use species

\*\*Indicates that designer must select a low water or drought-tolerant variety only

<sup>1</sup> Indicates Tree Species appropriate for 3'-6" min. width parkway or 4'-0" min. width landscape area

Botanical Name	Common Name	Project Entries	Signature Corridors: Green Valley Parkway Fieldstone Drive Murrleta Road Goetz Road	Perris Approved Street Tree List	Single Family Detached & Multi-Family Private Yards/In-tract Parkway	Multi-Family Common Areas	Parks/Schools	Open Space	Commercial/Mixed Used	Drainage Basin	Slopes
<i>Magnolia stellata</i>	Star Magnolia	●	●		●	●	●		●		
<i>Malus spp.</i>	Crabapple				●						●
<i>Maytenus boaria</i>	Mayten Tree				●						
<i>Melaleuca linariifolia</i>	Flaxleaf Paperbark	●	●	●	●	●	●		●		
<i>Melaleuca nesophila</i> *	Pink Melaleuca	●	●	●	●	●	●	●	●		●
<i>Melaleuca quinquenervia</i>	Cajeput Tree	●	●	●	●	●	●	●	●		
<i>Metasequoia glyptostroboides</i>	Dawn Redwood				●			●			
<i>Michelia doltsopa</i>	Michelia				●						
<i>Morus alba</i>	White Mulberry				●						
<i>Nerium oleander</i> *	Oleander			●	●						
<i>Nyssa sylvatica</i>	Sour Gum				●					●	
<i>Olea europaea 'Fruitless'</i> *	Fruitless Olive	●	●		●	●	●	●	●		●
<i>Olea europaea Majestic Beauty TM</i> *	Majestic Beauty TM Olive	●	●		●	●	●		●		●
<i>Olea europaea 'Swan Hill'</i> *	Swan Hill Olive	●	●	●	●	●	●		●		●
<i>Olneya tesota</i> *	Desert Ironwood			●	●			●			
<i>Parkinsonia aculeata</i> *	Mexican Palo Verde	●	●		●	●	●	●	●		
<i>Parkinsonia floridum</i> *	Blue Palo Verde	●	●		●	●	●	●	●		
<i>Parkinsonia microphylla</i> *	Littleleaf Palo Verde	●	●		●	●	●	●	●		
<i>Parkinsonia praecox</i> *	Palo Brea	●	●		●	●	●	●	●		
<i>Parkinsonia x 'Desert Museum'</i> *	Mexican Palo Verde	●	●		●	●	●	●	●		●
<i>Pinus attenuata</i> *	Knobcone Pine			●	●						●
<i>Pinus brutia</i> *	Calabrian Pine			●	●						●
<i>Pinus canariensis</i>	Canary Island Pine	●	●	●	●	●	●	●	●		●
<i>Pinus coulteri</i> *	Coulter Pine			●	●						●
<i>Pinus densiflora</i>	Japanese Red Pine				●						●
<i>Pinus edulis</i> *	Pinon Pine			●	●						●
<i>Pinus eldarica</i> *	Afghan Pine	●	●		●	●	●	●	●		●
<i>Pinus flexilis</i>	Limber Pine				●						●
<i>Pinus halepensis</i> *	Allepo Pine	●	●	●	●	●	●	●	●		●
<i>Pinus monophylla</i> *	Single Leaf Pinyon Pine			●	●						●
<i>Pinus nigra</i>	Austrian Black Pine				●						●
<i>Pinus pinea</i> *	Italian Stone Pine	●	●	●	●		●	●	●	●	●



LANDSCAPE MASTER COMMUNITY PLANT MATRIX

\*Indicates drought-tolerant or low-water use species

\*\*Indicates that designer must select a low water or drought-tolerant variety only

<sup>1</sup> Indicates Tree Species appropriate for 3’-6” min. width parkway or 4’-0” min. width landscape area

Botanical Name	Common Name	Project Entries	Signature Corridors: Green Valley Parkway Fieldstone Drive Murrleta Road Goetz Road	Perris Approved Street Tree List	Single Family Detached & Multi-Family Private Yards/In-tract Parkway	Multi-Family Common Areas	Parks/Schools	Open Space	Commercial/Mixed Used	Drainage Basin	Slopes
<i>Pinus ponderosa</i> *	Ponderosa Pine				●						●
<i>Pinus radiata</i>	Monterey Pine				●						●
<i>Pinus sabiniana</i> *	Gray Pine			●	●						●
<i>Pinus sylvestris</i>	Scotch Pine				●						●
<i>Pinus thunbergii</i>	Japanese Black Pine				●						●
<i>Pinus torreyana</i>	Torrey Pine				●			●	●		●
<i>Pistacia chinensis</i>	Chinese Pistache	●	●	●	●	●	●	●	●		●
<i>Pistacia chinensis</i> ‘Keith Davey’	Keith Davey Chinese Pistache	●	●		●	●	●		●		
<i>Pistacia chinensis</i> ‘Red Push’	Red Push Chinese Pistache	●	●		●	●	●		●		●
<i>Pittosporum phillyraeoides</i> * <sup>1</sup>	Willow Pittosporum			●	●						
<i>Pittosporum tenuifolium</i>	Blackstem Pittosporum	●	●		●	●	●		●		
<i>Platanus x acerifolia</i>	London Planetree	●	●	●	●	●	●	●	●	●	●
<i>Platanus x acerifolia</i> ‘Bloodgood’	Bloodgood Planetree	●	●		●	●	●	●	●		●
<i>Platanus x acerifolia</i> ‘Columbia’	Columbia London Planetree	●	●		●	●	●	●	●		●
<i>Platanus x acerifolia</i> ‘Yarwood’	Yarwood London Planetree	●	●		●	●	●	●	●		
<i>Platanus occidentalis</i>	American Sycamore							●			
<i>Platanus racemosa</i>	California Sycamore	●	●	●	●	●	●	●	●	●	●
<i>Podocarpus gracilior</i>	Fern Pine	●	●		●	●	●	●	●		
<i>Podocarpus henkelii</i>	Long-leafed Yellowwood	●	●	●	●	●	●	●	●		
<i>Podocarpus macrophyllus</i>	Yew Pine	●	●	●	●	●			●		
<i>Podocarpus macrophyllus</i> ‘Maki’	Shrubby Yew Pine	●	●		●	●			●		
<i>Populus canadensis</i>	Carolina Poplar									●	●
<i>Populus fremontii</i>	Fremont or Western Cottonwood	●	●	●				●		●	●
<i>Populus nigra</i> ‘Italica’	Lombardy Poplar	●						●		●	●
<i>Prosopis alba</i> *	Argentine Mesquite	●	●	●	●	●	●	●	●		
<i>Prosopis chilensis</i> *	Chilean Mesquite	●	●	●	●	●	●	●	●		●
<i>Prosopis glandulosa</i> *	Honey Mesquite	●	●	●	●	●	●	●	●		
<i>Prosopis glandulosa</i> ‘Maverick’*	Maverick Texas Honey Mesquite	●	●		●	●	●	●	●		



LANDSCAPE MASTER COMMUNITY PLANT MATRIX

\*Indicates drought-tolerant or low-water use species

\*\*Indicates that designer must select a low water or drought-tolerant variety only

<sup>1</sup>Indicates Tree Species appropriate for 3’-6” min. width parkway or 4’-0” min. width landscape area

Botanical Name	Common Name	Project Entries	Signature Corridors: Green Valley Parkway Fieldstone Drive Murrleta Road Goetz Road	Perris Approved Street Tree List	Single Family Detached & Multi-Family Private Yards/In-tract Parkway	Multi-Family Common Areas	Parks/Schools	Open Space	Commercial/Mixed Used	Drainage Basin	Slopes
<i>Prosopis hybrid</i> ‘Phoenix’ *	Phoenix Thornless Mesquite	●	●		●	●	●	●	●		●
<i>Prosopis juliflora</i> *	Arizona Mesquite	●	●	●	●	●	●	●	●		●
<i>Prosopis pubescens</i> *	Screwbean Mesquite	●	●	●	●	●	●	●	●		●
<i>Prosopis velutina</i> *	Arizona Mesquite	●	●	●	●	●	●	●	●		
<i>Prunus spp.</i>	Flowering Cherry	●	●		●	●	●		●		●
<i>Prunus caroliniana</i>	Carolina Laurel Cherry	●	●	●	●	●	●		●		●
<i>Prunus cerasifera var.</i>	Cherry Plum	●	●	●	●	●	●		●		●
<i>Prunus cerasifera</i> ‘Krauter Vesuvius’	Purple Leaf Plum	●	●		●	●	●		●		●
<i>Prunus cerasifera</i> ‘Thundercloud’	Purple Leaf Plum	●	●		●	●	●		●		●
<i>Prunus ilicifolia</i> *	Hollyleaf Cherry	●	●	●	●	●	●		●		●
<i>Prunus ilicifolia lyonii</i> *	Catalina Cherry	●	●	●	●	●		●			●
<i>Psidium cattleianum</i>	Strawberry Guava	●	●		●	●	●		●		●
<i>Punica granatum</i> *	Pomegranate	●	●	●	●						
<i>Pyrus calleryana</i>	Ornamental Pear	●	●		●	●	●		●		●
<i>Pyrus calleryana</i> ‘Aristocrat’	Aristocrat Pear	●	●		●	●	●		●		●
<i>Pyrus calleryana</i> ‘Bradford’	Bradford Pear	●	●		●	●	●		●		●
<i>Pyrus calleryana</i> ‘Chanticleer’	Chanticleer Pear	●	●		●	●	●		●		●
<i>Pyrus kawakamii</i>	Evergreen Pear	●	●		●	●	●		●		
<i>Quercus agrifolia</i> *	Coast Live Oak	●	●	●	●	●	●	●	●	●	●
<i>Quercus chrysolepis</i> *	Canyon Live Oak			●				●			●
<i>Quercus coccinea</i>	Scarlet Oak							●			●
<i>Quercus engelmannii</i> *	Mesa Oak	●	●	●	●	●	●	●	●		●
<i>Quercus ilex</i> *	Holly Oak	●	●	●	●	●	●	●	●		●
<i>Quercus kelloggii</i>	California Black Oak			●	●	●	●	●	●		●
<i>Quercus lobata</i>	Valley Oak	●	●	●	●	●	●	●	●		●
<i>Quercus suber</i> *	Cork Oak	●	●	●	●	●	●	●	●		●
<i>Quercus virginiana</i>	Southern Live Oak	●	●	●	●	●	●	●	●		
<i>Quercus wislizei</i> *	Interior Live Oak	●	●		●	●	●		●		●
<i>Rhaphiolepis indica</i> ‘Majestic Beauty’ <sup>1</sup>	Majestic Beauty Indian Hawthorn	●	●	●	●	●	●		●		●
<i>Rhus lancea</i> *	African Sumac	●	●	●	●	●	●		●		●
<i>Robinia neomexicana</i> *	Desert Locust	●	●	●	●	●					





**LANDSCAPE MASTER COMMUNITY PLANT MATRIX**

\*Indicates drought-tolerant or low-water use species

\*\*Indicates that designer must select a low water or drought-tolerant variety only

<sup>1</sup> Indicates Tree Species appropriate for 3'-6" min. width parkway or 4'-0" min. width landscape area

<b>Botanical Name</b>	<b>Common Name</b>	<b>Project Entries</b>	<b>Signature Corridors: Green Valley Parkway Fieldstone Drive Murieta Road Goetz Road</b>	<b>Perris Approved Street Tree List</b>	<b>Single Family Detached &amp; Multi-Family Private Yards/In-tract Parkway</b>	<b>Multi-Family Common Areas</b>	<b>Parks/Schools</b>	<b>Open Space</b>	<b>Commercial/Mixed Used</b>	<b>Drainage Basin</b>	<b>Slopes</b>
<i>Robinia X ambigua 'Idahoensis'</i> *	Idaho Locust	●	●		●	●					
<i>Robinia X ambigua 'Purple Robe'</i> *	Purple Robe Locust	●	●		●	●					
<i>Salix babylonica</i>	Weeping Willow				●	●				●	
<i>Salix gooddingii</i>	Black Willow				●	●				●	
<i>Sambucus mexicana</i> *	Blue Elderberry			●	●	●		●			
<i>Sophora japonica</i>	Japanese Pagoda Tree				●	●					●
<i>Sophora secundiflora</i> *	Mescal Bean Tree				●	●					●
<i>Sophora secundiflora 'Silver Sierra'</i> *	Silver Sierra, Texas Mountain Laurel				●	●					●
<i>Taxodium distichum</i>	Bald Cypress				●			●			
<i>Taxodium mucronatum</i>	Montezuma Cypress				●			●			
<i>Taxus baccata</i>	English Yew				●						
<i>Thuja plicata</i>	Western Red Cedar				●						●
<i>Tipuana tipu</i>	Tipu Tree	●	●	●	●	●	●	●	●	●	●
<i>Tristanopsis laurina</i> <sup>1</sup>	Water Gum	●	●	●	●	●	●	●	●		
<i>Ulmus parvifolia</i> *	Chinese or Evergreen Elm	●	●	●	●	●	●	●	●		●
<i>Ulmus parvifolia 'Allee'</i> *	Chinese Lacebark Elm	●	●		●	●	●		●		●
<i>Ulmus wilsonii 'True Green'</i>	True Green Chinese Elm				●	●	●		●		●
<i>Ulmus pumila</i> *	Siberian Elm				●	●	●		●		
<i>Umbellularia californica</i>	California Bay	●	●	●	●	●	●		●	●	●
<i>Vitex agnus-castus</i> *	Chaste Tree			●	●	●	●		●		
<i>Yucca spp.</i> *	Yucca	●	●		●	●	●		●		●
<i>Zelkova serrata</i>	Sawleaf Zelkova	●	●		●	●	●		●		●
<i>Zelkova serrata 'Village Green'</i>	Village Green Zelkova	●	●		●	●	●		●		●
<i>Ziziphus jujuba</i>	Jujube, Chinese Date				●	●	●		●		●
<b>PALMS</b>											
<i>Brahea edulis</i> *	Guadalupe Palm	●	●	●	●	●			●		
<i>Butia capitata</i> *	Pindo Palm	●	●	●	●	●			●		●
<i>Chamaerops humilis</i> *	Mediterranean Fan Palm	●	●		●	●	●		●		
<i>Cycas revoluta</i>	Sago Palm	●	●		●	●	●		●		
<i>Phoenix canariensis</i>	Canary Island Date Palm	●	●	●		●			●		
<i>Phoenix dactylifera</i> *	Edible Date Palm	●	●	●		●			●		



LANDSCAPE MASTER COMMUNITY PLANT MATRIX

\*Indicates drought-tolerant or low-water use species

\*\*Indicates that designer must select a low water or drought-tolerant variety only

<sup>1</sup> Indicates Tree Species appropriate for 3'-6" min. width parkway or 4'-0" min. width landscape area

Botanical Name	Common Name	Project Entries	Signature Corridors: Green Valley Parkway Fieldstone Drive Murrleta Road Goetz Road	Perris Approved Street Tree List	Single Family Detached & Multi-Family Private Yards/In-tract Parkway	Multi-Family Common Areas	Parks/Schools	Open Space	Commercial/Mixed Used	Drainage Basin	Slopes
<i>Trachycarpus fortunei</i> *	Windmill Palm	●	●	●	●	●	●		●		
<i>Washingtonia filifera</i> *	California Fan Palm	●	●	●	●	●	●		●		
<i>Washingtonia robusta</i> * <sup>1</sup>	Mexican Fan Palm	●	●	●	●	●	●		●		
<b>SHRUBS</b>											
<i>Abelia x grandiflora</i>	Glossy Abelia	●	●		●	●	●		●		
<i>Abelia x grandiflora</i> 'Edward Goucher'	Edward Goucher Abelia	●	●		●	●	●		●		
<i>Abutilon</i> spp.	Flowering Maple				●	●					
<i>Acacia</i> spp. **	Acacia	●	●		●	●	●		●		●
<i>Acacia ongerup</i>	NCN	●	●		●	●	●	●	●		
<i>Acanthus mollis</i>	Bear's Breech	●	●		●	●	●		●		
<i>Achillea millefolium</i> *	Yarrow	●	●		●	●	●	●	●	●	●
<i>Acer</i> spp.	Maple	●	●		●	●	●		●		●
<i>Adenostoma fasciculatum</i> *	Chamise				●	●		●	●		●
<i>Aesculus californica</i> *	California Buckeye				●	●		●	●		●
<i>Agapanthus</i> spp.	Lily of the Nile	●	●		●	●	●		●		
<i>Alyogyne huegelii</i> *	Blue Hibiscus	●	●		●	●	●	●	●	●	●
<i>Amorpha fruticosa</i> *	False Indigobush								●	●	
<i>Anigozanthos</i> spp. *	Kangaroo Paw	●	●		●	●	●		●		
<i>Anisodonteia x hypomandarum</i>	Cape Mallow				●	●		●	●		
<i>Arbutus unedo</i> 'Compacta' *	Dwarf Strawberry Tree	●	●		●	●	●	●	●		●
<i>Arctostaphylos</i> spp. **	Manzanita	●	●		●	●	●	●	●		●
<i>Artemisia</i> spp.	Artemisia				●	●	●	●	●		●
<i>Artemisia douglasiana</i> *	Mugwort				●	●	●	●	●	●	●
<i>Asclepia curvassavica</i> *	Blood Flower Milkweed				●	●	●		●		
<i>Asparagus</i> spp.	Ornamental Asparagus	●	●		●	●	●		●		
<i>Aspidistra elatior</i>	Cast Iron Plant	●	●		●	●	●		●		
<i>Asteriscus maritimus</i>	NCN				●	●					
<i>Athrium nipponicum</i> 'Pictum' *	Japanese Painted Fern	●	●		●	●	●		●		
<i>Atriplex canescens</i> *	Four Wing Saltbush				●	●		●	●		●
<i>Atriplex hymenelytra</i> *	Desert Holly				●	●		●	●		●
<i>Atriplex lentiformis</i> *	Quail Bush				●	●		●	●		●
<i>Atriplex nummularia</i> *	Old Man Saltbush				●	●			●		



LANDSCAPE MASTER COMMUNITY PLANT MATRIX

\*Indicates drought-tolerant or low-water use species

\*\*Indicates that designer must select a low water or drought-tolerant variety only

<sup>1</sup> Indicates Tree Species appropriate for 3'-6" min. width parkway or 4'-0" min. width landscape area

Botanical Name	Common Name	Project Entries	Signature Corridors: Green Valley Parkway Fieldstone Drive Murrleta Road Goetz Road	Perris Approved Street Tree List	Single Family Detached & Multi-Family Private Yards/In-tract Parkway	Multi-Family Common Areas	Parks/Schools	Open Space	Commercial/Mixed Used	Drainage Basin	Slopes
<i>Aucuba japonica</i>	Japanese Aucuba	●	●		●	●	●		●		
<i>Aucuba japonica</i> 'Crotonifolia'	Croton Leaf Aucuba	●	●		●	●	●		●		
<i>Aucuba japonica</i> 'Variegata'	Gold Dust Plant	●	●		●	●	●		●		
<i>Azalea</i> spp.	Azalea	●	●		●	●	●		●		
<i>Baccharis pilularis</i> var.*	Coyote Bush	●	●		●	●	●	●	●	●	●
<i>Baileyana multiradiata</i> *	Desert Marigold				●	●		●	●		
<i>Bambusa</i> spp.	Bamboo				●	●			●		
<i>Beaucarnia recurvata</i> *	Pony Tail Palm	●	●		●	●	●		●		
<i>Berberis</i> spp.	Barberry				●	●		●	●		●
<i>Berberis thunbergii</i> var.	Japanese Barberry				●	●		●	●		●
<i>Bergenia cordifolia</i>	Heartleaf Bergenia				●				●		
<i>Bougainvillea</i> spp. *	Bougainvillea	●	●		●	●	●		●		●
<i>Brugmansia x candida</i>	Angel's Trumpet				●	●			●		
<i>Buddleja davidii</i> var.	Butterfly Bush	●	●		●	●	●	●	●		●
<i>Buxus</i> spp.	Boxwood	●	●		●	●	●		●		
<i>Caesalpinia gilliesii</i> *	Yellow Bird of Paradise	●	●		●	●	●	●	●		●
<i>Caesalpinia mexicana</i> *	Mexican Bird of Paradise	●	●		●	●	●	●	●		●
<i>Caesalpinia pulcherrima</i>	Red Bird of Paradise	●	●		●	●	●	●	●		●
<i>Calliandra californica</i> *	Baja Fairy Duster				●	●		●	●		●
<i>Calliandra eriophylla</i> *	Fairy Duster				●	●		●	●		●
<i>Calliandra tweedii</i> *	Brazilian Flame Bush				●	●		●	●		●
<i>Callistemon</i> spp.	Bottlebrush	●	●		●	●	●		●		●
<i>Calocephalus brownii</i> *	Cushion Bush				●	●		●	●		●
<i>Calycanthus occidentalis</i>	Spicebush				●	●		●	●	●	●
<i>Calylophus drummondii</i> *	Sundrops				●	●		●	●	●	●
<i>Camellia</i> spp.	Camellia	●	●		●	●	●		●		
<i>Capparis spinosa</i> *	Caper Bush				●	●			●		
<i>Carpenteria californica</i>	Bush Anemone				●	●			●		
<i>Ceanothus</i> spp.**	Lilac	●	●		●	●	●	●	●	●	●
<i>Centaurea cineraria</i>	Dusty Miller				●	●	●		●		
<i>Centranthus ruber</i> *	Jupiter's Beard				●	●			●		
<i>Cephalanthus occidentalis</i>	Button Bush				●	●			●		





LANDSCAPE MASTER COMMUNITY PLANT MATRIX

\*Indicates drought-tolerant or low-water use species

\*\*Indicates that designer must select a low water or drought-tolerant variety only

<sup>1</sup> Indicates Tree Species appropriate for 3'-6" min. width parkway or 4'-0" min. width landscape area

Botanical Name	Common Name	Project Entries	Signature Corridors: Green Valley Parkway Fieldstone Drive Murrleta Road Goetz Road	Perris Approved Street Tree List	Single Family Detached & Multi-Family Private Yards/In-tract Parkway	Multi-Family Common Areas	Parks/Schools	Open Space	Commercial/Mixed Used	Drainage Basin	Slopes
<i>Cerocarpus betuloides</i> *	Mountain Mahogany				●	●			●		●
<i>Cerocarpus ledifolius</i> *	Curl-leaf Mountain Mahogany				●	●			●		●
<i>Chamelaucium uncinatum</i> *	Geraldton Wax Flower				●	●			●		
<i>Chondropetalum tectorum</i>	Cape Rush				●	●		●	●	●	
<i>Chrysactinia mexicana</i> *	Damianita				●	●			●		
<i>Cistus spp.</i> **	Rockrose	●	●		●	●	●	●	●		●
<i>Clivia miniata</i>	NCN	●	●		●	●	●		●		
<i>Cocculus laurifolius</i>	Laurelleaf Snail Seed				●	●	●		●		
<i>Coleonema spp.</i>	Breath Of Heaven	●	●		●	●	●		●		
<i>Convolvulus cneorum</i> *	Bush Morning Glory	●	●		●	●	●	●	●		
<i>Coprosma spp.</i>	Mirror Plant	●	●		●	●	●		●		●
<i>Cordia boissieri</i> *	Texas Olive				●	●			●		●
<i>Cordia parvifolia</i> *	Little Leaf Cordia				●	●			●		●
<i>Cordyline australis var.</i>	Australian Dracaena	●	●		●	●			●		
<i>Coreopsis spp.</i>	Coreopsis				●	●			●		●
<i>Cornus alba</i>	Tatarian Dogwood				●	●			●	●	●
<i>Cornus sericea</i>	Red Twig Dogwood				●	●			●	●	●
<i>Correa alba</i>	White Australian Fuchsia				●	●			●		●
<i>Correa pulchella</i> *	Australian Fuchsia				●	●			●		●
<i>Cotinus coggygria</i> *	Smoke Tree				●	●			●		●
<i>Cotoneaster spp.</i>	Cotoneaster	●	●		●	●	●		●		
<i>Cuphea ignea</i>	Cigar Plant				●	●			●		
<i>Cryptomeria japonica 'Pygmaea'</i>	Dwarf Cryptomeria				●	●			●		●
<i>Cyathea cooperi</i>	Australian Tree Fern	●	●		●	●	●		●		
<i>Cyperus alternifolius</i>	Umbrella Plant	●	●		●	●	●		●	●	
<i>Cyperus papyrus</i>	Papyrus	●	●		●	●	●		●	●	
<i>Dendromecon hartfordii</i> *	Island Bush Poppy				●	●		●	●		●
<i>Dendromecon rigida</i> *	Bush Poppy				●	●		●	●		●
<i>Dianella tasmanica</i>	NCN	●	●		●	●	●		●		
<i>Dicksonia antarctica</i>	Tasmanian Tree Fern	●	●		●	●	●		●		
<i>Diets bicolor</i>	Fortnight Lily	●	●		●	●	●		●		



LANDSCAPE MASTER COMMUNITY PLANT MATRIX

\*Indicates drought-tolerant or low-water use species

\*\*Indicates that designer must select a low water or drought-tolerant variety only

<sup>1</sup> Indicates Tree Species appropriate for 3'-6" min. width parkway or 4'-0" min. width landscape area

Botanical Name	Common Name	Project Entries	Signature Corridors: Green Valley Parkway Fieldstone Drive Murrleta Road Goetz Road	Perris Approved Street Tree List	Single Family Detached & Multi-Family Private Yards/In-tract Parkway	Multi-Family Common Areas	Parks/Schools	Open Space	Commercial/Mixed Used	Drainage Basin	Slopes
<i>Dietes vegeta</i>	Fortnight Lily	●	●		●	●	●		●		
<i>Dodonaea viscosa</i>	Hopseed Bush	●	●		●	●	●	●	●		●
<i>Dodonaea viscosa 'Purpurea'</i>	Purple-leafed Hopseed Bush	●	●		●	●	●	●	●		●
<i>Dryopteris arguta</i> *	California Wood Fern				●	●			●		●
<i>Duranta erecta</i>	Sky Flower				●	●					
<i>Echinacea purpurea</i>	Purple Cornflower				●	●		●			
<i>Echium fastuosum</i> *	Pride of Madeira	●	●		●	●	●		●		●
<i>Eleagnus pungens var.</i> *	Silverberry				●	●					
<i>Encelia spp.</i> *	Brittlebush				●	●		●	●		●
<i>Equisetum hyemale</i>	Horsetail Reed				●	●			●	●	
<i>Eremophila maculata</i> *	Spotted Emu Bush				●	●					●
<i>Erigeron karvinskianus</i>	Santa Barbara Daisy				●	●			●		
<i>Eriogonum spp.</i> *	Buckwheat				●	●		●	●		●
<i>Erysimum 'Bowles Mauve'</i>	Bowles Mauve Wallflower				●	●					
<i>Eschscholzia californica</i> *	California Poppy	●	●		●	●	●	●		●	●
<i>Euonymus spp.</i>	Euonymus	●	●		●	●	●		●		
<i>Euonymus fortunei</i>	NCN	●	●		●	●	●		●		
<i>Euonymus japonicus</i>	Evergreen Euonymus	●	●		●	●	●		●		
<i>Euphorbia pulcherrima</i>	Poinsettia	●	●		●	●	●		●		
<i>Euphorbia rigida</i> *	Yellow Spurge	●	●		●	●	●		●		
<i>Fatshedera lizei</i>	Botanical Wonder	●	●		●	●	●		●		
<i>Fatsia japonica</i>	Japanese Aralia	●	●		●	●	●		●		
<i>Feijoa sellowiana</i>	Pineapple Guava	●	●		●	●	●		●		
<i>Forestiera neomexicana</i> *	New Mexican Privet				●	●			●		●
<i>Fremontodendron spp.</i> *	Flannel Bush				●	●		●	●		
<i>Gaillardia x grandiflora</i>	Blanketflower				●	●		●			
<i>Galvezia speciosa</i> *	Island Bush Snapdragon				●	●		●	●		●
<i>Gardenia spp.</i>	Gardenia	●	●		●	●	●		●		●
<i>Gaura lindheimeri</i>	NCN				●	●					
<i>Geranium incanum</i>	Crane's Bill	●	●		●	●					



LANDSCAPE MASTER COMMUNITY PLANT MATRIX

\*Indicates drought-tolerant or low-water use species

\*\*Indicates that designer must select a low water or drought-tolerant variety only

<sup>1</sup> Indicates Tree Species appropriate for 3'-6" min. width parkway or 4'-0" min. width landscape area

Botanical Name	Common Name	Project Entries	Signature Corridors: Green Valley Parkway Fieldstone Drive Murrleta Road Goetz Road	Perris Approved Street Tree List	Single Family Detached & Multi-Family Private Yards/In-tract Parkway	Multi-Family Common Areas	Parks/Schools	Open Space	Commercial/Mixed Used	Drainage Basin	Slopes
<i>Grevillea spp.</i> *	Grevillea	●	●		●	●	●		●		●
<i>Grewia occidentalis</i>	Lavender Starflower	●	●		●	●	●		●		●
<i>Hebe spp.</i>	Veronica	●	●		●	●	●		●		
<i>Helianthemum nummularium</i> *	Sunrose				●	●					
<i>Helichrysum petiolare</i>	Licorice Plant				●	●					
<i>Hemerocallis spp.</i> **	Daylily	●	●		●	●	●		●		
<i>Heteromeles arbutifolia</i> *	Toyon	●	●		●	●	●	●	●		●
<i>Heuchera hybrids</i>	Hybrid Coral Bells	●	●		●	●	●	●	●		●
<i>Heuchera maxima</i>	Island Alum Root	●	●		●	●	●	●	●	●	●
<i>Heuchera micrantha</i>	Coral Bells	●	●		●	●	●	●	●		●
<i>Heuchera sanguinea</i>	Coral Bells	●	●		●	●	●	●	●		●
<i>Hibiscus spp.</i>	Hibiscus	●	●		●	●	●		●		
<i>Hydrangea spp.</i>	Hydrangea	●	●		●	●	●		●		
<i>Hypericum spp.</i>	St. Johnswort, Goldflower	●	●		●	●	●		●		
<i>Hyptis emoryi</i> *	Desert Lavender				●	●		●			
<i>Ilex spp.</i>	Holly	●	●		●	●			●		
<i>Iris douglasiana</i>	Douglas Iris				●	●		●	●	●	●
<i>Isocoma menziesii</i> *	Goldenbush	●	●		●	●		●	●	●	●
<i>Isomeris arborea</i> *	Bladderpod	●	●		●	●	●	●	●		●
<i>Iva hayesiana</i> *	Hayes Iva									●	●
<i>Juniperus spp.</i> **	Juniper	●	●		●	●	●		●		●
<i>Justicia brandegeana</i>	Shrimp Plant				●	●			●		
<i>Justicia californica</i> *	Chuparosa				●	●			●	●	
<i>Kniphofia uvaria</i> *	Red Hot Poker	●	●		●	●			●		
<i>Lantana spp.</i> *	Lantana	●	●		●	●	●		●		●
<i>Lavandula spp.</i> *	Lavender	●	●		●	●	●		●		●
<i>Lavandula angustifolia</i> *	English Lavender	●	●		●	●	●		●		●
<i>Lavatera assurgentifolia</i> *	Tree Mallow				●	●			●		●
<i>Lavatera maritima</i>	Tree Mallow				●	●					
<i>Leonotis leonorus</i> *	Lion's Tail				●	●					
<i>Leptospermum scoparium</i> var.	New Zealand Tea Tree	●	●		●	●	●		●		
<i>Leucophyllum spp.</i> *	Texas Ranger	●	●		●	●	●	●	●		●





LANDSCAPE MASTER COMMUNITY PLANT MATRIX

\*Indicates drought-tolerant or low-water use species

\*\*Indicates that designer must select a low water or drought-tolerant variety only

<sup>1</sup> Indicates Tree Species appropriate for 3'-6" min. width parkway or 4'-0" min. width landscape area

Botanical Name	Common Name	Project Entries	Signature Corridors: Green Valley Parkway Fieldstone Drive Murrleta Road Goetz Road	Perris Approved Street Tree List	Single Family Detached & Multi-Family Private Yards/In-tract Parkway	Multi-Family Common Areas	Parks/Schools	Open Space	Commercial/Mixed Used	Drainage Basin	Slopes
<i>Ligustrum japonicum</i>	Japanese Privet	●	●		●	●	●		●		
<i>Ligustrum japonicum 'Texanum'</i>	Wax Leaf Privet	●	●		●	●	●		●		
<i>Ligustrum lucidum</i>	Glossy Privet, White Wax Tree	●	●		●	●	●		●		
<i>Limonium perezii</i>	Sea Lavender	●	●		●	●	●		●		
<i>Liriope muscari</i>	Big Blue Lily Turf	●	●		●	●	●		●		
<i>Lobelia laxiflora *</i>	Red Mexican Lobelia	●	●		●	●	●		●		●
<i>Lonicera spp.</i>	Honeysuckle	●	●		●	●	●		●		●
<i>Loropetalum chinense</i>	Fringe Flower	●	●		●	●	●		●		
<i>Mahonia spp.</i>	Oregon Grape				●	●				●	●
<i>Malacothamnus fasciculatus *</i>	Chaparral Mallow				●	●		●			●
<i>Melianthus major</i>	Honey Bush				●	●					
<i>Michelia figo</i>	Banana Shrub				●	●					
<i>Mimulus aurantiacus*</i>	Sticky Monkey Flower				●	●		●			●
<i>Mimulus bifidus</i>	Santa Lucia Monkey Flower				●	●		●			●
<i>Mimulus cardinalis</i>	Monkey Flower				●	●		●		●	●
<i>Mimulus multiflora</i>	Colorado Four O' Clock				●	●		●			●
<i>Mimulus puniceus</i>	Red Monkey Flower				●	●					●
<i>Myoporum laetum</i>	Myoporum	●	●		●	●	●		●		●
<i>Myrsine africana</i>	African Boxwood	●	●		●	●	●		●		
<i>Myrtus spp.</i>	Myrtle	●	●		●	●	●		●		●
<i>Nandina domestica</i>	Heavenly Bamboo	●	●		●	●	●		●		
<i>Nephrolepis cordifolia</i>	Sword Fern	●	●		●	●	●		●		
<i>Nerium oleander *</i>	Oleander	●	●		●	●		●			
<i>Oenothera caespitosa *</i>	Tufted Evening Primrose				●	●					●
<i>Oenothera speciosa *</i>	Showy Evening Primrose				●	●					●
<i>Oenothera stubbei *</i>	Saltillo Evening Primrose				●	●					●
<i>Ophiopogon japonicus</i>	Mondo Grass	●	●		●	●	●		●		
<i>Ophiopogon planiscapus 'Nigrescens'</i>	Black Mondo Grass	●	●		●	●	●		●		
<i>Osmanthus fragrans</i>	Sweet Olive	●	●		●	●	●		●		
<i>Pelargonium x hortorum</i>	Garden Geranium	●	●		●	●	●		●		



LANDSCAPE MASTER COMMUNITY PLANT MATRIX

\*Indicates drought-tolerant or low-water use species

\*\*Indicates that designer must select a low water or drought-tolerant variety only

<sup>1</sup> Indicates Tree Species appropriate for 3'-6" min. width parkway or 4'-0" min. width landscape area

Botanical Name	Common Name	Project Entries	Signature Corridors: Green Valley Parkway Fieldstone Drive Murrleta Road Goetz Road	Perris Approved Street Tree List	Single Family Detached & Multi-Family Private Yards/In-tract Parkway	Multi-Family Common Areas	Parks/Schools	Open Space	Commercial/Mixed Used	Drainage Basin	Slopes
<i>Penstemon spp.</i>	Penstemon				●	●		●			
<i>Perovskia atriplicifolia</i>	Russian Sage				●	●					
<i>Philodendron bipinnatifolium</i>	Split Leaf Philodendron	●	●		●	●	●		●		
<i>Phlomis fruticosa</i> *	Jerusalem Sage				●	●					●
<i>Phormium spp.</i>	Flax	●	●		●	●	●		●		
<i>Photinia x fraseri</i>	Fraser's Photinia	●	●		●	●	●		●		
<i>Phyllostachys aurea</i>	Golden Bamboo				●	●			●		
<i>Phyllostachys bambusoides</i>	Giant Timber Bamboo				●	●			●		
<i>Pittosporum spp.</i>	Pittosporum	●	●		●	●	●		●		●
<i>Pittosporum tobira 'Wheeler's Dwarf'</i>	Wheeler's Dwarf Tobira	●	●		●	●	●		●		
<i>Plumbago auriculata</i>	Cape Plumbago	●	●		●	●	●		●		●
<i>Polygala dalmaisiana</i>	Sweet Pea Shrub				●	●					
<i>Polypodium californicum</i> *	California Polypody				●	●				●	
<i>Polystichum munitum</i>	California Sword Fern				●	●				●	
<i>Portulacaria afra</i> *	Elephant's Food	●	●		●	●	●		●		
<i>Prunus caroliniana 'Compacta'</i>	Dwarf Carolina Laurel Cherry	●	●		●	●	●		●		●
<i>Psidium cattleianum</i>	Strawberry Guava	●	●		●	●	●		●		●
<i>Punica granatum</i> *	Pomegranate	●	●		●	●			●		
<i>Pyracantha spp.</i>	Pyracantha	●	●		●	●	●		●		
<i>Rhamnus alaternus variegata</i>	Italian Buckthorn				●	●			●		●
<i>Rhamnus californica var. *</i>	California Coffeeberry	●	●		●	●		●	●		●
<i>Rhaphiolepis spp.</i>	Indian Hawthorn	●	●		●	●	●		●		
<i>Rhaphiolepis indica 'Springtime'</i>	Pink Indian Hawthorn	●	●		●	●	●		●		
<i>Rhus ovata</i> *	Sugar Bush	●	●		●	●	●	●	●		●
<i>Rhus trilobata</i> *	Three Leaf Sumac				●	●			●		●
<i>Ribes spp.</i>	Currant				●	●			●		●
<i>Ribes malvaceum</i> *	Chaparral Currant				●	●		●	●		●
<i>Ribes sanguineum</i>	Pink Winter Currant				●	●			●		●
<i>Ribes speciosum</i>	Fuschia-flowering Gooseberry				●	●			●	●	●
<i>Romneya coulteri</i> *	Matilija Poppy	●	●		●	●	●	●	●		●



LANDSCAPE MASTER COMMUNITY PLANT MATRIX

\*Indicates drought-tolerant or low-water use species

\*\*Indicates that designer must select a low water or drought-tolerant variety only

<sup>1</sup> Indicates Tree Species appropriate for 3'-6" min. width parkway or 4'-0" min. width landscape area

Botanical Name	Common Name	Project Entries	Signature Corridors: Green Valley Parkway Fieldstone Drive Murrleta Road Goetz Road	Perris Approved Street Tree List	Single Family Detached & Multi-Family Private Yards/In-tract Parkway	Multi-Family Common Areas	Parks/Schools	Open Space	Commercial/Mixed Used	Drainage Basin	Slopes
<i>Romneya 'White Cloud'</i> *	White Cloud Matilija Poppy	●	●		●	●	●	●	●		●
<i>Rosa spp.</i>	Rose	●	●		●	●	●		●		●
<i>Rosa californica</i> *	Wild Rose	●	●		●	●	●		●	●	●
<i>Rosmarinus spp.</i> **	Rosemary	●	●		●	●	●		●		●
<i>Ruellia brittoniana</i>	British Ruellia	●	●		●	●			●		
<i>Salvia spp.</i> **	Sage	●	●		●	●	●		●		●
<i>Sambucus mexicana</i> *	Mexican Elderberry				●	●		●		●	●
<i>Santolina chamaecyparissus</i> *	Lavender Cotton	●	●		●	●	●		●		●
<i>Satureja douglasii</i> *	Yerba Buena				●	●				●	
<i>Senna artemisioides</i> *	Feathery Cassia				●	●					
<i>Senna nemophylla</i> *	Desert Cassia				●	●					●
<i>Senna phyllodinea</i> *	Silver Leaf Cassia				●	●					●
<i>Simmondsia chinensis</i> *	Joboba				●	●					
<i>Solanum rantonnetii</i>	Paraguay Nightshade	●	●		●	●	●		●		
<i>Sophora secundiflora</i> *	Texas Mountain Laurel				●	●			●		
<i>Sphaeralcea ambigua</i> *	Apricot Mallow				●	●					
<i>Spirea spp.</i>	NCN				●	●			●		
<i>Spirea bumalda 'Froebelii'</i>	Froebeli Spirea				●	●					
<i>Stachys byzantine</i>	Lamb's Ears	●	●		●	●	●		●		
<i>Strelitzia reginae</i>	Bird of Paradise	●	●		●	●	●		●		
<i>Symphoricarpos spp.</i> *	Snowberry				●	●			●		●
<i>Syzygium paniculatum</i>	Australian Brush Cherry				●	●					
<i>Tagetes lemmonii</i> *	Copper Canyon Daisy				●	●					
<i>Tagetes lucida</i>	Mexican Marigold				●	●					●
<i>Taxus baccata</i>	English Yew	●	●		●	●					
<i>Tecoma capensis</i>	Cape Honeysuckle	●	●		●	●	●		●		
<i>Ternstroemia gymnanthera</i>	Ternstroemia				●	●					
<i>Teucrium spp.</i>	Germander	●	●		●	●	●		●		
<i>Thuja orientalis</i>	Oriental Arborvitae	●	●		●	●	●		●		
<i>Trachelospermum jasminoides</i>	Star Jasmine	●	●		●	●	●		●		
<i>Tricostema lanatum</i> *	Woolly Blue Curls				●	●			●		
<i>Tulbaghia violacea</i>	Society Garlic	●	●		●	●	●		●		





LANDSCAPE MASTER COMMUNITY PLANT MATRIX

\*Indicates drought-tolerant or low-water use species

\*\*Indicates that designer must select a low water or drought-tolerant variety only

<sup>1</sup> Indicates Tree Species appropriate for 3'-6" min. width parkway or 4'-0" min. width landscape area

Botanical Name	Common Name	Project Entries	Signature Corridors: Green Valley Parkway Fieldstone Drive Murrleta Road Goetz Road	Perris Approved Street Tree List	Single Family Detached & Multi-Family Private Yards/In-tract Parkway	Multi-Family Common Areas	Parks/Schools	Open Space	Commercial/Mixed Used	Drainage Basin	Slopes
<i>Venegasia carpesioides</i> *	Canyon Sunflower								●	●	
<i>Viburnum spp.</i>	Viburnum	●	●		●	●	●		●		●
<i>Viburnum tinus 'Spring Bouquet'</i>	Laurustinus	●	●		●	●	●		●		●
<i>Westringia fruticosa</i> *	Coast Rosemary	●	●		●	●	●		●		●
<i>Xylosma congestum</i>	Xylosma, Glossy Xylosma	●	●		●	●	●		●		●
<i>Xylosma congestum 'Compacta'</i>	Compact Xylosma	●	●		●	●	●		●		●
<i>Yucca spp.**</i>	Yucca	●	●		●	●	●		●		●
<i>Zauschneria californica</i> *	California Fuschia	●	●		●	●	●		●		●
<b>SUCCULENTS</b>											
<i>Agave spp. *</i>	Agave	●	●		●	●	●		●		●
<i>Aloe spp. *</i>	Aloe	●	●		●	●	●		●		●
<i>Bulbine frutescens</i> *	Yellow Stalked Bulbine	●	●		●	●	●		●		●
<i>Bulbine frutescens 'Hallmark'</i> *	Orange Hallmark Bulbine	●	●		●	●	●		●		●
<i>Bulbine frutescens 'Yellow'</i> *	Yellow Bulbine	●	●		●	●	●		●		●
<i>Dasyliirion wheeleri</i> *	Desert Spoon	●	●		●	●	●		●		●
<i>Echeveria spp. *</i>	Hen and Chicks	●	●		●	●	●		●		●
<i>Echinocactus grusonii</i> *	Golden Barrel Cactus	●	●		●						●
<i>Euphorbia rigida</i> *	Blue Euphorbia	●	●		●	●			●		
<i>Euphorbia spp. *</i>	Euphorbia	●	●		●	●			●		
<i>Ferocactus cylindraceus</i> *	Compass Barrel Cactus	●	●		●						●
<i>Ferocactus wislizenii</i> *	Fish Hook Barrel Cactus	●	●		●						●
<i>Fouquieria splendens</i> *	Ocotillo	●	●		●	●			●		●
<i>Hesperaloe funifera</i> *	Giant Hesperaloe	●	●		●	●	●		●		●
<i>Hesperaloe parviflora</i> *	Red Yucca	●	●		●	●	●		●		●
<i>Herperaloe parviflora 'Yellow'</i> *	Yellow Hesperaloe	●	●		●	●	●		●		●
<i>Nolina bigloveii</i> *	Desert Nolina	●	●		●	●	●		●		●
<i>Opuntia spp. *</i>	Prickly Pear	●	●		●	●	●		●		●
<i>Pachypodium lamerei</i>	Madagascar Palm	●	●		●	●	●		●		
<i>Portulacaria afra</i> *	Elephant's Food, Elephant Bush	●	●		●	●	●		●		
<i>Sedum spp. *</i>	Sedum	●	●		●	●	●	●	●		●
<i>Yucca spp. *</i>	Yucca	●	●		●	●	●	●	●		●



**LANDSCAPE MASTER COMMUNITY PLANT MATRIX**

\*Indicates drought-tolerant or low-water use species

\*\*Indicates that designer must select a low water or drought-tolerant variety only

<sup>1</sup> Indicates Tree Species appropriate for 3'-6" min. width parkway or 4'-0" min. width landscape area

Botanical Name	Common Name	Project Entries	Signature Corridors: Green Valley Parkway Fieldstone Drive Murrleta Road Goetz Road	Perris Approved Street Tree List	Single Family Detached & Multi-Family Private Yards/In-tract Parkway	Multi-Family Common Areas	Parks/Schools	Open Space	Commercial/Mixed Used	Drainage Basin	Slopes
<b>GROUNDCOVER</b>											
<i>Acacia redolens</i> *	Spreading Acacia	●	●		●	●	●	●	●		●
<i>Achillea</i> spp.**	Yarrow	●	●		●	●	●	●	●		●
<i>Ajuga reptans</i> var.	Carpet Bugle	●	●		●	●			●		
<i>Anemopsis californica</i>	Yerba mansa	●	●		●	●	●	●	●	●	
<i>Arctostaphylos</i> spp.	Manzanita	●	●		●	●	●	●	●		●
<i>Arctostaphylos</i> 'Pacific Mist' *	Pacific Mist Manzanita	●	●		●	●	●	●	●		●
<i>Armeria maritima</i>	Sea Pink	●	●		●	●	●	●	●		
<i>Baccharis pilularis</i> *	Dwarf Coyote Brush	●	●		●	●	●	●	●		●
<i>Baccharis pilularis</i> 'Twin Peaks'*	Twin Peaks Coyote Brush	●	●		●	●			●		●
<i>Baccharis</i> 'Centennial' *	Centennial Coyote Brush	●	●		●	●	●	●	●	●	●
<i>Bergenia cordifolia</i>	Heartleaf Bergenia	●	●		●	●	●		●		
<i>Campanula poscharskyana</i>	Serbian Bellflower	●	●		●	●			●		
<i>Ceanothus griseus</i> var.	Carmel Creeper	●	●		●	●	●	●	●		●
<i>Centranthus ruber</i> *	Jupiter's Beard	●	●		●	●	●	●	●		●
<i>Cerastium tomentosum</i>	Snow-in-Summer	●	●		●	●	●		●		
<i>Coprosma repens</i>	Mirror Plant	●	●		●	●	●		●		●
<i>Cotoneaster dammeri</i>	Bearberry Cotoneaster	●	●		●	●			●		
<i>Cyclamen persicum</i> *	Cyclamen	●	●		●	●	●		●		
<i>Dianthus</i> spp.	Carnation	●	●		●	●	●		●		
<i>Dichondra micrantha</i>	Dichondra	●	●		●	●	●		●		
<i>Duchesnea indica</i>	Indian Mock Strawberry	●	●		●	●	●		●		
<i>Dymondia margaretae</i> *	NCN	●	●		●	●	●		●		●
<i>Festuca glauca</i>	Blue Fescue	●	●		●	●	●		●		●
<i>Fragaria chiloensis</i>	Ornamental Strawberry	●	●		●	●	●		●		●
<i>Fragaria</i> 'Pink Panda'	Pink Panda Ornamental Strawberry	●	●		●	●	●		●		●
<i>Gazania hybrids</i>	Hybrid Gazania	●	●		●	●	●		●		●
<i>Gazania</i> spp.	Gazania	●	●		●	●	●		●		
<i>Gazania splendens</i> 'Mitsuwa Yellow'	Mitsuwa Yellow Gazania	●	●		●	●	●		●		
<i>Geranium</i> spp.	Cranesbill	●	●		●	●	●		●		●
<i>Hedera canariensis</i>	Algerian Ivy	●	●		●	●	●		●		●



LANDSCAPE MASTER COMMUNITY PLANT MATRIX

\*Indicates drought-tolerant or low-water use species

\*\*Indicates that designer must select a low water or drought-tolerant variety only

<sup>1</sup> Indicates Tree Species appropriate for 3'-6" min. width parkway or 4'-0" min. width landscape area

Botanical Name	Common Name	Project Entries	Signature Corridors: Green Valley Parkway Fieldstone Drive Murrleta Road Goetz Road	Perris Approved Street Tree List	Single Family Detached & Multi-Family Private Yards/In-tract Parkway	Multi-Family Common Areas	Parks/Schools	Open Space	Commercial/Mixed Used	Drainage Basin	Slopes
<i>Hedera helix</i>	English Ivy	●	●		●	●	●		●		●
<i>Herniaria glabra</i>	Green Carpet	●	●		●	●	●		●		
<i>Heuchera spp.**</i>	Coral Bells	●	●		●	●	●		●		●
<i>Hypericum spp.</i>	St. John's Wort	●	●		●	●	●		●		
<i>Hypericum calycinum</i>	Aaron's Beard	●	●		●	●	●		●		
<i>Iberis sempervirens</i>	Evergreen Candytuft	●	●		●	●	●		●		
<i>Impatiens wallerana</i>	Impatiens	●	●		●	●	●		●		
<i>Juniperus spp.</i>	Juniper	●	●		●	●	●		●		●
<i>Lantana spp. *</i>	Lantana	●	●		●	●	●		●		●
<i>Lobelia erinus</i>	Lobelia	●	●		●	●	●		●		
<i>Lonicera japonica 'Halliana' *</i>	Hall's Honeysuckle	●	●		●	●	●		●		●
<i>Mahonia repens *</i>	Creeping Mahonia	●	●		●	●	●		●		
<i>Muehlenbeckia axillaris</i>	Creeping Wire Vine	●	●		●	●	●		●		●
<i>Myoporum parvifolium *</i>	Ground Cover Myoporum	●	●		●	●	●	●	●		●
<i>Myoporum parvifolium 'Putah Creek' *</i>	Putah Creek Myoporum	●	●		●	●	●	●	●		●
<i>Ophiopogon spp.</i>	Mondo Grass	●	●		●	●	●		●		
<i>Osteospermum spp. *</i>	Freeway Daisy	●	●		●	●	●		●		●
<i>Osteospermum fruticosum var.*</i>	Trailing African Daisy	●	●		●	●	●		●		●
<i>Pelargonium peltatum</i>	Ivy Geranium	●	●		●	●	●		●		●
<i>Potentilla species</i>	Cinquefoil	●	●		●	●	●		●		●
<i>Rosa Ground Cover varieties</i>	Ground Cover Rose	●	●		●	●	●		●		●
<i>Rosmarinus o. 'Prostratus' *</i>	Prostrate Rosemary	●	●		●	●	●		●		
<i>Santolina chamaecyparissus *</i>	Lavender Cotton	●	●		●	●	●		●		
<i>Scaevola 'Mauve Clusters'</i>	Fairy Fan Flower	●	●		●	●	●		●		
<i>Sedum morganianum *</i>	Donkey Tail	●	●		●	●	●		●		●
<i>Sedum rubrotinctum *</i>	Pork and Beans	●	●		●	●	●		●		●
<i>Soleirolia soleirolli</i>	Baby's Tears	●	●		●	●	●		●		
<i>Thymus spp. **</i>	Thyme	●	●		●	●	●		●		●
<i>Trachelospermum asiaticum</i>	Yellow Star Jasmine	●	●		●	●	●		●		●
<i>Verbena spp.**</i>	Verbena	●	●		●	●	●		●		
<i>Vinca minor*</i>	Dwarf Periwinkle	●	●		●	●	●		●		●





LANDSCAPE MASTER COMMUNITY PLANT MATRIX

\*Indicates drought-tolerant or low-water use species

\*\*Indicates that designer must select a low water or drought-tolerant variety only

<sup>1</sup> Indicates Tree Species appropriate for 3'-6" min. width parkway or 4'-0" min. width landscape area

Botanical Name	Common Name	Project Entries	Signature Corridors: Green Valley Parkway Fieldstone Drive Murrleta Road Goetz Road	Perris Approved Street Tree List	Single Family Detached & Multi-Family Private Yards/In-tract Parkway	Multi-Family Common Areas	Parks/Schools	Open Space	Commercial/Mixed Used	Drainage Basin	Slopes
<i>Vinca minor</i> 'Sterling Silver' <sup>*</sup>	Sterling Silver Periwinkle	●	●		●	●	●		●		●
<i>Zauschneria californica</i> *	California Fuchsia	●	●		●	●	●		●		
<i>Zinnia angustifolia</i>	Zinnia	●	●		●	●	●		●		
<i>Zoysia tenuifolia</i>	Korean Grass	●	●		●	●	●		●		
<b>VINES</b>											
<i>Antigonon leptopus</i> *	Coral Vine	●	●		●	●	●		●		●
<i>Bougainvillea spp.</i> *	Bougainvillea	●	●		●	●	●		●		●
<i>Bougainvillea spectabilis</i> *	Bougainvillea	●	●		●	●	●		●		●
<i>Cissus antartica</i>	Kangaroo Treevine	●	●		●	●	●		●		●
<i>Cissus hypoglauca</i>	NCN	●	●		●	●	●		●		●
<i>Clematis armandii</i>	Evergreen Clematis	●	●		●	●	●		●		●
<i>Clytostoma callistegioides</i>	Lavender Trumpet Vine	●	●		●	●	●		●		●
<i>Distictus buccinatoria</i>	Scarlet Trumpet Vine	●	●		●	●	●		●		●
<i>Gelsemium sempervirens</i>	Carolina Jessamine	●	●		●	●	●		●		●
<i>Hardenbergia violacea</i>	Lilac Vine	●	●		●	●	●		●		●
<i>Hardenbergia violacea</i> 'Rosea'	Pink Lilac Vine	●	●		●	●	●		●		●
<i>Hedera spp.</i>	Ivy	●	●		●	●	●		●		●
<i>Jasminum mesnyi</i>	Primrose Jasmine	●	●		●	●	●		●		●
<i>Jasminum polyanthum</i>	Pink Jasmine	●	●		●	●	●		●		●
<i>Lonicera hildebrandeana</i>	Giant Burmese Honeysuckle	●	●		●	●	●		●		●
<i>Lonicera japonica</i> *	Japanese Honeysuckle	●	●		●	●	●		●		●
<i>Lonicera japonica</i> 'Halliana' *	Hall's Honeysuckle	●	●		●	●	●		●		●
<i>Macfadyena unguis-cati</i> *s	Cat's Claw Vine	●	●		●	●	●		●		●
<i>Parthenocissus 'Hacienda Creeper'</i>	Hacienda Creeper	●	●		●	●	●		●		●
<i>Parthenocissus quinquefolia</i>	Virginia Creeper	●	●		●	●	●		●		●
<i>Parthenocissus tricuspidata</i>	Boston Ivy	●	●		●	●	●		●		●
<i>Parthenocissus tricuspidata</i> 'Veitchi'	Boston Ivy	●	●		●	●	●		●		●
<i>Passiflora jamesonii</i>	NCN	●	●		●	●	●		●		●
<i>Rosa 'Cecile Brunner'</i>	Cecile Brunner Rose	●	●		●	●	●		●		●
<i>Rosa banksiae</i> 'Alba Plena'	dbl. White Lady Banks' Rose	●	●		●	●	●		●		●
<i>Rosa banksiae</i> 'Lutea'	Yellow Lady Banks' Rose	●	●		●	●	●		●		●



LANDSCAPE MASTER COMMUNITY PLANT MATRIX

\*Indicates drought-tolerant or low-water use species

\*\*Indicates that designer must select a low water or drought-tolerant variety only

<sup>1</sup> Indicates Tree Species appropriate for 3'-6" min. width parkway or 4'-0" min. width landscape area

Botanical Name	Common Name	Project Entries	Signature Corridors: Green Valley Parkway Fieldstone Drive Murrleta Road Goetz Road	Perris Approved Street Tree List	Single Family Detached & Multi-Family Private Yards/In-tract Parkway	Multi-Family Common Areas	Parks/Schools	Open Space	Commercial/Mixed Used	Drainage Basin	Slopes
<i>Rosa spp.</i>	Climbing Rose	●	●		●	●	●		●		●
<i>Solandra maxima</i>	Cup of Gold Vine	●	●		●	●	●		●		●
<i>Solanum jasminoides</i>	Potato Vine	●	●		●	●	●		●		●
<i>Thunbergia alata</i>	Black-eyed Susan Vine	●	●		●	●	●		●		●
<i>Trachelospermum asiaticum</i>	Asian Jasmine	●	●		●	●	●		●		●
<i>Trachelospermum jasminoides</i>	Star Jasmine	●	●		●	●	●		●		●
<i>Vigna caracalla</i>	Snail Vine	●	●		●	●	●		●		●
<i>Vitis californica</i> *	California Wild Grape	●	●		●	●	●		●	●	●
<i>Vitis californica 'Roger's Red'</i> *	Roger's Red California Grape	●	●		●	●	●		●	●	●
<i>Wisteria spp.</i>	Wisteria	●	●		●	●	●		●		●
<b>GRASSES/WILDFLOWER</b>											
<i>Acorus gramineus 'Ogon'</i>	Japanese Sweet Flag	●	●		●	●	●		●	●	
<i>Acorus gramineus 'Variegata'</i>	Variegated Japanese Sweet Flag	●	●		●	●	●		●	●	
<i>Agrostis stolonifera</i>	Creeping Bent	●	●		●	●	●		●		
<i>Aristida purpurea</i> *	Purple Three-Awn	●	●		●	●	●		●	●	
<i>Bouteloua curtipendula</i> *	Sideoats Grama Grass	●	●		●	●	●		●		●
<i>Bouteloua gracilis</i> *	Blue Grama Grass	●	●		●	●	●		●		●
<i>Calamagrostis acutiflora</i>	Feather Reed Grass	●	●		●	●	●	●	●	●	
<i>Carex barbara</i>	Santa Barbara Sedge	●	●		●	●	●		●		●
<i>Carex buchananii</i>	Leather Leaf Sedge	●	●		●	●	●	●	●	●	●
<i>Carex elata</i> *	Golden Variegated Sedge	●	●		●	●	●	●	●	●	●
<i>Carex flacca</i>	Blue Sedge	●	●		●	●	●	●	●	●	●
<i>Carex flagellifera</i>	Weeping Brown Sedge	●	●		●	●	●	●	●	●	●
<i>Carex pansa</i>	California Meadow Sedge	●	●		●	●	●	●	●	●	●
<i>Carex praegracillis</i>	California Field Sedge	●	●		●	●	●		●		●
<i>Carex spp.</i>	Sedge	●	●		●	●	●		●		●
<i>Carex spissa</i> *	San Diego Sedge	●	●		●	●	●	●	●	●	●
<i>Carex testacea</i>	Brown Sedge	●	●		●	●	●	●	●	●	●
<i>Carex tumulicola</i> *	Berkeley Sedge	●	●		●	●	●	●	●	●	●
<i>Deschampsia flexuosa</i>	Crinkled Hair Grass	●	●		●	●	●	●	●	●	



LANDSCAPE MASTER COMMUNITY PLANT MATRIX

\*Indicates drought-tolerant or low-water use species

\*\*Indicates that designer must select a low water or drought-tolerant variety only

<sup>1</sup> Indicates Tree Species appropriate for 3'-6" min. width parkway or 4'-0" min. width landscape area

Botanical Name	Common Name	Project Entries	Signature Corridors: Green Valley Parkway Fieldstone Drive Murrleta Road Goetz Road	Perris Approved Street Tree List	Single Family Detached & Multi-Family Private Yards/In-tract Parkway	Multi-Family Common Areas	Parks/Schools	Open Space	Commercial/Mixed Used	Drainage Basin	Slopes
<i>Dichelostemma capitatum</i> *	Bluedicks	●	●		●	●	●		●		
<i>Distichlis spicata</i> *	Salt Grass	●	●		●	●	●		●	●	
<i>Eleocharis montevidensis</i>	Spike Rush	●	●		●	●	●		●	●	
<i>Elymus glaucus</i>	Blue Wildrye	●	●		●	●	●		●		
<i>Elymus magellanicus</i>	Magellan Wheatgrass	●	●		●	●	●		●	●	
<i>Epilobium canum</i> *	California Fuchsia	●	●		●	●	●		●		
<i>Eschscholzia californica</i> *	California Poppy	●	●		●	●	●		●		
<i>Festuca glauca</i>	Blue Fescue	●	●		●	●	●		●		●
<i>Festuca idahoensis</i>	Fescue	●	●		●	●	●	●	●	●	●
<i>Festuca rubra</i> 'Molate'	Pt. Molate Fescue	●	●		●	●	●		●		
<i>Gilia tricolor</i>	Bird's Eyes	●	●		●	●	●		●		
<i>Helictotrichon sempervirens</i>	Blue Oat Grass	●	●		●	●	●		●		
<i>Imperata cylindrica</i> 'Red Baron'	Red Baron Japanese Blood Grass	●	●		●	●	●	●	●	●	
<i>Imperata cylindrica</i> 'Rubra'	Japanese Blood Grass	●	●		●	●	●	●	●		
<i>Juncus acutus</i>	Spiny Rush	●	●		●	●	●		●		●
<i>Juncus balticus</i>	Rush	●	●		●	●	●		●		●
<i>Juncus effusus</i>	Common Rush	●	●		●	●	●		●		●
<i>Juncus effusus pacificus</i> 'Quartz Creek'	Quartz Creek Soft Rush	●	●		●	●	●		●		●
<i>Juncus patens</i> *	Spreading Rush	●	●		●	●	●	●	●	●	●
<i>Lasthenia californica</i>	Goldfields	●	●		●	●	●		●		
<i>Layia fremontii</i>	Tidy Tips	●	●		●	●	●		●		
<i>Leymus condensatus</i>	Wild Rye	●	●		●	●	●		●	●	
<i>Leymus condensatus</i> 'Canyon Prince'	Canyon Prince Wild Rye	●	●		●	●	●		●	●	
<i>Leymus triticoides</i> 'Grey Dawn'	Creeping Wild Rye	●	●		●	●	●	●	●	●	
<i>Lomandra longifolia</i> 'Breeze'	Dwarf Mat Rush	●	●		●	●	●	●	●	●	
<i>Lupinus microcarpus</i>	White-Whorled Lupine	●	●		●	●	●		●		
<i>Lupinus microcarpus</i> var. <i>densiflorus</i>	Golden Lupine	●	●		●	●	●		●		
<i>Lupinus nanus</i>	Sky Lupine	●	●		●	●	●		●		
<i>Lupinus succulentus</i>	Arroyo Lupine	●	●		●	●	●	●	●	●	
<i>Milium effusum aureum</i>	Bowles Golden Grass	●	●		●	●	●	●	●	●	





LANDSCAPE MASTER COMMUNITY PLANT MATRIX

\*Indicates drought-tolerant or low-water use species

\*\*Indicates that designer must select a low water or drought-tolerant variety only

<sup>1</sup> Indicates Tree Species appropriate for 3'-6" min. width parkway or 4'-0" min. width landscape area

Botanical Name	Common Name	Project Entries	Signature Corridors: Green Valley Parkway Fieldstone Drive Murrleta Road Goetz Road	Perris Approved Street Tree List	Single Family Detached & Multi-Family Private Yards/In-tract Parkway	Multi-Family Common Areas	Parks/Schools	Open Space	Commercial/Mixed Used	Drainage Basin	Slopes
<i>Miscanthus spp.</i>	Miscanthus	●	●		●	●	●		●	●	
<i>Molina caerulea variegata</i>	Moor Grass	●	●		●	●	●	●	●	●	
<i>Muhlenbergia spp.</i>	Muhlenbergia	●	●		●	●	●		●		●
<i>Muhlenbergia capillaris</i> *	Hairy Awn Muhly	●	●		●	●	●		●	●	●
<i>Muhlenbergia rigens</i>	Deergrass	●	●		●	●	●		●	●	●
<i>Nassella lepida</i> *	Foothill Needlegrass	●	●		●	●	●		●		●
<i>Nassella pulchra</i> *	Purple Needlegrass	●	●		●	●	●		●		●
<i>Nassella tenuissima</i> *	Mexican Feather Grass	●	●		●	●	●		●		●
<i>Nolina bigelovii</i> *	Nolina	●	●		●	●	●		●		
<i>Ophiopogon jaburan vittatus</i>	Snakebeard	●	●		●	●	●		●		
<i>Ophiopogon japonicus</i>	Mondo Grass	●	●		●	●	●		●		
<i>Panicum virgatum 'Heavy Metal'</i>	Switch Grass	●	●		●	●	●		●	●	
<i>Pennisetum spp.</i> *	Fountain Grass	●	●		●	●	●		●		
<i>Pennisetum 'Eaton Canyon'</i> *	Dwarf Red Fountain Grass	●	●		●	●	●		●	●	
<i>Penstemon heterophyllus</i> *	Foothill Penstemon	●	●		●	●	●		●		
<i>Phalaris arundinacea 'Picta'</i>	Variegated Ribbon Grass	●	●		●	●	●		●		
<i>Phalaris arundinacea 'Rosea'</i>	Ribbon Grass	●	●		●	●	●		●		
<i>Scripus cernuus</i>	Fiber Optics Plant	●	●		●	●	●	●	●	●	
<i>Scirpus tabernaemontani</i>	Soft-stem Bulrush	●	●		●	●	●		●		
<i>Sesleria autumnalis</i>	Autumn Moor Grass	●	●		●	●	●		●	●	
<i>Sisyrinchium bellum</i> *	Blue-Eyed Grass	●	●		●	●	●		●	●	
<i>Solidago californica</i>	California Goldenrod	●	●		●	●	●	●	●		
<i>Sporobolus airoides</i> *	Alkali Sacaton	●	●		●	●	●		●	●	●
<i>Sporobolus wrightii</i> *	Giant Dropseed	●	●		●	●	●		●		
<i>Stipa pulchra</i> *	Needle Grass	●	●		●	●	●		●		
<i>Triteleia laxa</i> *	Ithuriel's Spear	●	●		●	●	●		●		
<i>Zoysia 'De Anza'</i>	Turf Zoysia De Anza	●	●		●	●	●		●		



#### **4.5 DESIGN REVIEW PROCESS**

##### **4.5.1 Introduction**

The Green Valley Design Guidelines have been created to provide property owners, architects, home builders, and contractors with a set of parameters for the preparation of their drawings and specifications. Adherence to these Guidelines will assure builders that a consistent level of quality will be maintained. The Green Valley Architectural Review Committee (or the “Committee”) and the City will review all designs, plans, and construction to ensure:

- Primary site design issues have been adequately considered,
- Excellence in architectural design,
- The unique landscape potential of the homesite is addressed, and
- Compatibility and integration with surrounding land uses.

##### **4.5.2 Design Review Committee**

The Green Valley development is designed to be a unique community of high-quality homes. The future community’s Covenants, Conditions, and Restrictions (CC&R’s) may not list specific design items necessary for plan approval. Rather, the authority to approve or disapprove individual building and landscaping plans is given to the Green Valley Design Review Committee. The Committee does not seek to restrict individual creativity or preferences, but rather maintain within the overall community the aesthetic relationship between homes, natural amenities, and surrounding neighbors. As the community matures, these key relationships will become increasingly important, requiring coordination through the design process.

The Committee is composed of three members or more, as decided upon by the Project Master Developer, who are intricately involved in the development of the community. Additionally, an architect or other design professional, who is a non-owner, may serve on or act as a consultant to the Committee.

The Committee will use the Design Guidelines for the purpose of review, but may individually consider the merits of any design due to special conditions that, in the opinion of the Committee, provide benefits to the adjacent areas, the specific site, or to the community as a whole. Alternate materials/ architectural styles that are deemed equivalent may be permitted, subject to Planning Commission approval.

##### **4.5.3 Compliance**

The Green Valley Specific Plan and the Design Review Committee Planned Development Permit provides zoning and development standards for this project, with further project-level refinements included in these Design Guidelines. The City Planning staff, Planning Commission, and City Council will use these Design Guidelines as a vehicle to review specific development proposals and to implement the project’s vision and regulations. Future development proposals and plans, whether individual buildings or collectively phased projects, must comply with these Guidelines, as well as the General Plan, Green Valley Specific Plan, and Zoning Code, where applicable. These Design Guidelines are intended to be used by City staff, property owners, architects, landscape architects, designers, builders, and developers in the planning and design of individual projects within the Plan Area.



**4.5.4 Conflicts with City Code and other Approved Entitlements or Policies**

Design components within the “Public Realm” (as defined in the Community Design Guidelines) cannot be amended without the consent of all “Participating Landowners” (as defined in development agreements between the landowners and the City). Therefore, the Community Design Guidelines will prevail in the event of any inconsistencies between these Design Guidelines, Guidelines of the City of Perris, and the Green Valley Specific Plan. Where these Design Guidelines provide greater specificity on design detail for components of projects within the Public Realm, the Community Development Director shall determine that the project level design detail of components is consistent with, and does not purport to amend, the requirements set forth in the Design Guidelines.

Conversely, any particular element or provision not specifically covered in these Design Guidelines shall be subject to the provisions of the GVSP and/or the local Municipal Code as applicable. As provided for in the GVSP, in any instances where the Design Guidelines conflict with the requirements of the local Municipal Code, the Design Guidelines will take precedence. If none of these entitlements or policy documents addresses a specific provision, the local Municipal Code requirements remain in force.

**4.5.5 Modifications and Amendments**

The Design Guidelines are intended to encourage and direct a high level of design quality to the project site while permitting flexibility for creative expression and innovative design solutions. However, deviations to these guidelines may be considered for projects with special and unique design characteristics during the Green Valley Design Review Committee (GVDRC) and the City’s Design Review process and are categorized as either minor administrative modifications or amendments. Amendments to these Design Guidelines shall be reviewed as require by the Green Valley Specific Plan, the local Municipal Code, and/or California Government Code Section 65453.

Minor administrative modifications shall also include, but are not limited to, architectural style design modifications and architectural material substitutions that are consistent with and do not substantially change the overall intent of these Design Guidelines. Review and approval of minor administrative modifications shall be conducted by the Community Development Director.

The Director of Development Services may, at its discretion, defer to review and action of any item where it has decision making authority to the City Planning Commission and/or City Council; however, unless subject to an appeal, minor administrative modifications do not require review by either of these legislative bodies. Decisions of the Director of Development Services are subject to appeal to the Planning Commission, and decisions of the Planning Commission are subject to appeal to the City Council.

**4.5.6 Residential Design Review Process**

The design review process described in this section is intended to ensure that residential villages within Green Valley contribute to the character and quality envisioned for the neighborhood. This four step process is intended to be efficient, without compromising the quality of design solutions. The Green Valley Design Review Committee (GVDRC), comprised of representatives of the master developer and design professionals appointed by the master developer, will review all designs developed for the Green Valley neighborhoods prior to submittal to the City.





*Step One: Project Application*

The design review process will commence upon receipt of the Builder’s application form and review fee. At the applicant’s request, a kick-off and orientation meeting with the GVDRC during the phase may be scheduled.

Submittal Requirements:

1. Completed application form and fee.

*Step Two: Preliminary Design Review*

This step is intended to establish and define the project’s preliminary architectural and landscape character and concepts. Upon review and approval of the Builder’s submittal package, the GVDRC will schedule a Preliminary Design Review Session, during which the GVDRC will meet with the builder to review and discuss the submittal.

The Preliminary Design Review Session is an opportunity to review the following design criteria:

- Selected architectural styles from the Green Valley Design Guidelines. Applicant may propose additional architectural styles that are consistent with the neighborhood vision for the GVDRC’s review and approval.
- Architectural form, massing, roofs, and details, which establish character.
- Preliminary concepts for colors and materials.
- Landscape concepts identifying major tree and shrub massing, hardscape areas, and proposed character.
- Wall and fencing.

Following the Preliminary Design Review, the GVDRC shall prepare and submit to the applicant, within 15 business days of plan submittal, a written memorandum outlining the agreed-upon direction of the GVDRC and the applicant.

Submittal Requirement

**Civil / Planning**

2. Location map showing project location within the overall neighborhood.

**Landscape**

1. Landscape concept plans, identifying the general planting scheme, street tree program, typical front, side, and rear yards. Plans shall be prepared at a minimum scale of 1” =20’.
2. Color illustrative depicting typical landscape treatment for the last three contiguous lots, including one corner lot. The typical plan shall include at least one of each floor plan proposed for the project. The plan shall include a description of the landscape concept.

**Architecture**

1. Preliminary building floor plans and front elevations for all proposed plans. These shall be prepared at a minimum scale of 1/4” =1’-0”.
2. Building coverage or floor area ratio calculations.
3. Consistency with project development standards and architectural guidelines.



4. Architectural color and material sample boards (or equivalent information as approved by the GVDRC) for every color scheme by architectural style intended. These should be noted by elevation style for each product.

The GVDRC will issue a Preliminary Design Review Memorandum (PDRM) detailing the results of the Preliminary Design Review. The PDRM will state one of the following:

1. Approved to move forward to Final Design Review
2. Approved to move forward to Final Design Review with Comments & Conditions
3. Denied with Comments; resubmittal of Preliminary Design Review is required.

*Step Three: Final Design Review*

This step is intended to review the specific designs for the architecture and landscape elements of the project.

Upon receipt of an approved PDRM, more detailed project plans shall be prepared and submitted to the GVDRC for design review. Plans shall be a progression of the approved plan and direction established during Preliminary Design Review.

Professionals licensed to practice in the State of California shall prepare all Architecture, Civil Engineering, and Landscape Architecture plans. No non-licensed design work shall be permitted.

Submittal Requirements:

**Civil / Planning**

1. Dimensioned site plan showing
  - a. Building footprints
  - b. Porches and patios
  - c. Garages
  - d. Street curbs and rights-of-way
  - e. Easements
  - f. Driveways and walkways
  - g. Dimensioned building setbacks
  - h. Compliance with project development standards
  - i. Garbage locations

**Landscape**

1. Landscape Plans (minimum scale 1" =20") including:
  - a. Cover sheet with sheet index
  - b. Plant material and hardscape list and key, including finishes and colors of hardscape and fencing
  - c. Typical landscape planting and irrigation plans for each unique footprint type and each lot type (i.e., corner lot, loop lot, or other non-standard lot
  - d. Fencing ,hardscape, and planting details
  - e. Fencing site plan



- f. Plant lists should include species diversity identified with WUCOLS ratings, relating to water efficient landscape ordinance AB 1881
2. Site Plan/Landscape Concept for Model Home Complex, Sales Office and Temporary Marketing Facility (minimum scale 1" =20").

**Architecture**

1. Colored street scene showing at least three contiguous lots, actually occurring within the subject site, including one corner lot. Each plan type and an example of each selected architectural style must be depicted. The lot number, plan type, and architectural style shall be identified for each lot.
2. Architectural construction drawings, including floor plans, roof plans, secondary unit plans, alternatives or options, all exterior elevations (including interior courts), sections, and key details, prepared at a minimum scale of 1/4" =1'-0".
3. Architectural color and material sample boards (or equivalent information as approved by the GVDRC) for every color scheme by architectural style intended. These should be noted by elevation style for each product.
4. The builder shall submit to the GVDRC plotting for each phase of construction to ensure that housing diversity is delivered for each neighborhood.

**Miscellaneous**

1. Comment response memo identifying the steps taken to address GVDRC comments from Step 2: Preliminary Design Review.
2. Estimated Construction Schedule for completion of the project, including improvements, model home complex site improvements, and phasing.

*Step Four: City Design Review Submittal*

After final approval by the GVDRC, applicant shall submit for Design Review by the City of Perris. The Community Development Department will evaluate and determine the proposed project's consistency with the Green Valley Design Guidelines and the City's other applicable requirements as set forth in the subsection "Conflicts with City Code and other Approved Entitlements or Policies" of these Design Guidelines (and in the order of priority established in that subsection).

*Step Five: Construction Document Review*

After Design Review approval by the City of Perris, applicant shall submit completed construction documents to the GVDRC to review for consistency of designs with approvals through the design review process.

Within 15 days of construction document submittal, the GVDRC will submit to the applicant a memorandum indicating one of the following:

1. Approved to move forward for building permit submittal to the City of Perris.
2. Denied with comments; resubmittal of construction documents is required.

The GVDRC reserves the right to inspect plans and conduct field investigations.





5  
A  
P  
P  
E  
N  
D  
I  
X



**5 Appendix**





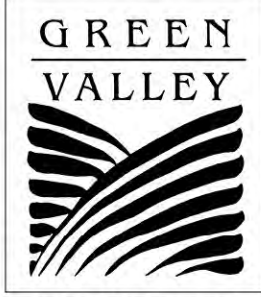


FIGURE 5-2



**SURVEYOR'S NOTES**

1. ● INDICATES FOUND MONUMENTS AS NOTED.
2. ALL DIMENSIONS ARE MEASURED IN FEET AND DECIMAL PARTS THEREOF.
3. ALL BEARINGS READ IN A NORTHERLY DIRECTION UNLESS OTHERWISE NOTED.
4. TOTAL AREA OF THE SUBJECT PROPERTY IS 839.32 ACRES MORE OR LESS.
5. PROPERTY WAS SURVEYED IN ACCORDANCE WITH FIRST AMERICAN TITLE COMPANY, PRELIMINARY REPORT NO. NHSC-2829276(TC), DATED JULY 10, 2015, UPDATE #1.
6. THIS SURVEY WAS PERFORMED WITH TRIMBLE S8 TOTAL STATIONS & TRIMBLE 5800 GPS RECEIVERS, AND COMPLETED ON JUNE 17, 2015.
7. ( ) INDICATES RECORD OR CALCULATED DATA PER MB 226/88-100, UNLESS OTHERWISE NOTED.
8. < > INDICATES RECORD OR CALCULATED DATA PER PM 218/71-75.
9. [ ] INDICATES RECORD OR CALCULATED DATA PER PM 230/33-34.
10. [ ] INDICATES RECORD OR CALCULATED DATA PER LOT LINE ADJUSTMENT NO. 95-0019, RECORDED FEBRUARY 15, 1996 AS INSTRUMENT NUMBERS 054778 AND 054779, BOTH OF OFFICIAL RECORDS.
11. SYMBOLS SHOWN ON THE SURVEY ARE NOT DRAFTED TO SCALE.
12. // // // INDICATED RESTRICTED ACCESS.

**BASIS OF BEARINGS**

THE BASIS OF BEARINGS FOR THIS SURVEY IS THE CALIFORNIA STATE PLANE COORDINATE SYSTEM, CCS83, ZONE 6, BASED LOCALLY ON CONTROL STATIONS "MLFP" AND "PPBF" NAD 83(NRS2007) AS SHOWN HEREON. ALL BEARINGS SHOWN ON THIS MAP ARE GRID, QUOTED BEARINGS AND DISTANCES FROM REFERENCE MAPS OR DEEDS ARE AS SHOWN PER THAT RECORD REFERENCE. ALL DISTANCES SHOWN ARE GROUND DISTANCES UNLESS SPECIFIED OTHERWISE. GRID DISTANCES, MAY BE OBTAINED BY MULTIPLYING THE GROUND DISTANCE BY A COMBINATION FACTOR OF 1.00007717. CALCULATIONS ARE MADE AT POINT NUMBER 1 WITH COORDINATES OF: N: 2219096.14, E: 6260627.53, USING AN ELEVATION OF 1475.61 (NAVD88), THE CONVERGENCE ANGLE AT POINT NO. 1 IS -0°32'59.93"

**BENCHMARK DATA**

CITY OF SUN CITY BM Z 10989.  
 PD. 2 1/4in. BRASS DISK FLUSH STAMPED "CAL DOT 9/10/16/15 REPL. GR. STONE FD. 1950" ON ETHANAC AC BRIDGE DECK OVER I-215 FREEWAY  
 ELEVATION = 1450.319 (NAVD88)  
 NDS  
 DESIGNATION: 435  
 PID: DX5442  
 DESCRIBED BY METRO WATER DIST. SO. CALIFORNIA 1992  
 PERRIS, 1300 FEET (396.2 M) WEST OF 475F RAILROAD ALONG RIDER ST. ON TOP OF NORTH CURB FACE OF RIDER ST. 28 FEET (8.5 M) NORTH OF RIDER ST. 6 FEET (1.8 M) SOUTH OF A GTE TELEPHONE BOX (DAMAGED). A STANDARD 3-1/4 INCH ALUMINUM DUST SET FLUSH IN TOP OF CURB.  
 ELEVATION = 1515.12(NAVD88)



THIS MAP DOES NOT SHOW THE EXISTENCE OR LOCATION OF ALL EASEMENTS WHICH MAY ENCLUMBER THE SITE.

REVISIONS	DATE	BY

**GREEN VALLEY**

**BOUNDARY/CONTROL SURVEY MAP**  
 LYING IN SECTIONS 4, 5, 8 AND 9 IN TOWNSHIP 5 SOUTH,  
 RANGE 3 WEST, S.B.M., IN THE CITY OF PERRIS,  
 COUNTY OF RIVERSIDE, STATE OF CALIFORNIA

SCALE: NO SCALE	ALBERT A. WEBB ASSOCIATES	ENGINEERING CONSULTANTS 3788 MCCRAY STREET RIVERSIDE, CA. 92506 PH. (951) 686-1070 FAX (951) 788-1256	W.O. 2015-0185 SHEET 1 OF 9 SHEETS DWG. NO. 15-0185 SU.DWG
DATE: 07/13/2015	DESIGNED: KM	CHECKED: JH	PLN. CK. REF: 7-04



C:\2015\15-0185 SURVEY\DRAWING\15-0185 SU.DWG 7/29/2015 12:04:43 PM



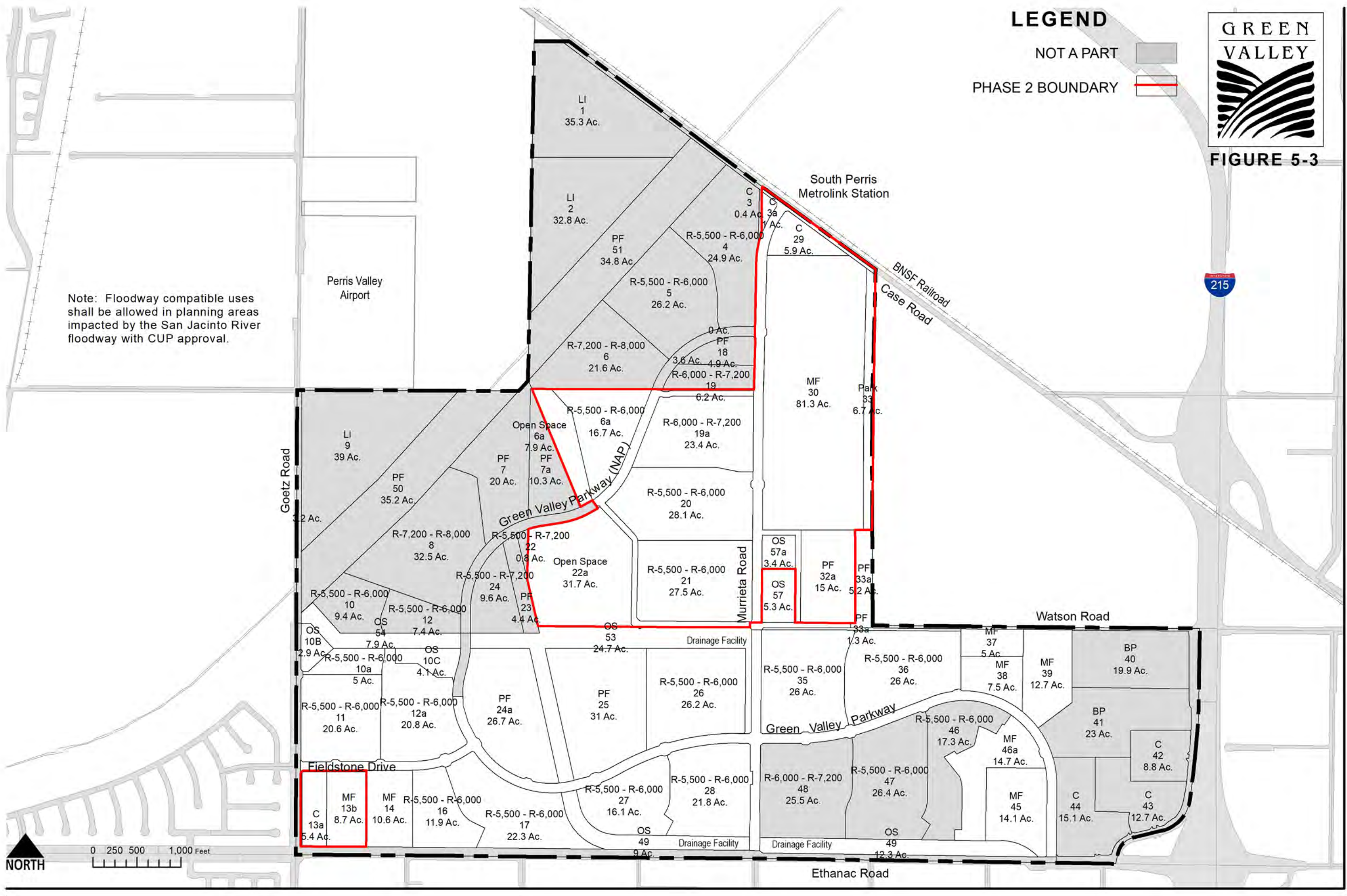


FIGURE 5-3

LEGEND

- NOT A PART [Grey Box]
- PHASE 2 BOUNDARY [Red Line]

Note: Floodway compatible uses shall be allowed in planning areas impacted by the San Jacinto River floodway with CUP approval.









**Approved Master Plan of Service and Phase 1A**

**Prepared by Webb Associates**

**October 2017**

(under separate cover)

**Green Valley Specific Plan  
2<sup>nd</sup> Amendment Appendix 5  
Implementation Guidelines  
April, 2023**

<b>Development Services</b>	
1	<b>Environmental Impact Report, Addendum, and Mitigation Monitoring and Reporting Program.</b> The project shall at all times comply with all provisions of the Supplemental Mitigation Monitoring and Reporting Program (MMRP) for the GVSP Phase 2 Addendum EIR dated November 2022 and the adopted MMRP for the Green Valley Specific Plan Final EIR certified March 5, 1990, if the 1990 measures were not updated or replaced by the 2023 measures.
2	<b>Development Standards.</b> The project shall conform to all requirements of the Green Valley Specific Plan (GVSP) and Community Park Memorandum of Understanding, May 11, 2021. Where the Specific Plan is silent on a development standard, the project shall conform to the City of Perris Municipal Code Title 19 - Zoning Ordinance. Chapter 3 of the Green Valley Specific Plan contains development standards for all residential, retail commercial, business/professional, light industrial, public facilities, and open space projects within Green Valley.
3	<b>Specific Plan Amendment.</b> The approval is for the Specific Plan Amendment 2. All tracts north of Watson Road are only required to submit a Tentative Parcel Map and/or Development Plan Review for residential development. These Specific Plan Implementation Guidelines remain as part of the amended Specific Plan, unless amended in the future.
4	<b>Conformance to Approved Specific Plan.</b> Development of the project site, building elevations, and conceptual landscaping shall conform substantially to the approved set of plans presented at the March, 2023 Planning Commission hearing, or as amended by these conditions and as approved by the City Council. Any project that does not substantially conform to the Planning Commission approved Specific Plan Amendment, set of plans, or amended by these conditions and as approved by the City Council shall require appropriate Planning Division review and approval. These conditions adopted with the 2 <sup>nd</sup> Specific Plan Amendment shall supersede all prior conditions applicable to the Specific Plan whether or not those prior conditions have been fulfilled or completed.
5	<b>Romoland Unified School District.</b> The proposed subdivision shall adhere to the standard requirements and mitigation fees established by the Romoland Unified School District.
6	<b>Riverside Transit Agency (RTA).</b> All future bus stop locations, material, architecture, and colors shall conform to the Green Valley Specific Plan.
7	<b>ADA Compliance.</b> The project shall conform to all disabled access requirements in accordance with the State of California, Title 24, and Federal Americans with Disabilities Act (ADA).
8	<b>Property Maintenance.</b> The project shall comply with provisions of Perris Municipal Code 7.06 regarding Landscape Maintenance, and Chapter 7.42 regarding Property Maintenance.

**Green Valley Specific Plan  
2<sup>nd</sup> Amendment Appendix 5  
Implementation Guidelines  
April, 2023**

9	<b>Indemnification.</b> The developer/applicant shall indemnify, protect, defend, and hold harmless, the City and any agency or instrumentality thereof, and/or any of its officers, employees and agents from any and all claims, actions, or proceedings against the City, or any agency or instrumentality thereof, or any of its officers, employees and agents, to attack, set aside, void, annul, or seek monetary damages resulting from an approval of the City, or any agency or instrumentality thereof, advisory agency, appeal board or legislative body including actions approved by the voters of the City, concerning Specific Plan Amendment (SPA) 21-05125. The City shall promptly notify the developer/applicant of any claim, action, or proceeding for which indemnification is sought and shall further cooperate fully in the defense of the action.
13	<b>EMWD Treatment Plant and Dam Inundation Disclosure.</b> The owner shall disclose to all future tenants indicating the project is in close proximity to the EMWD treatment plant and a dam inundation area making the site subject to flooding in the event of a dam failure.
14	<b>Mitigation Measures for Prior to Grading and during Grading.</b> Prior to grading permit issuance, the applicant is required to adhere to the mitigation measures in the Supplemental Mitigation Monitoring and Reporting Program (MMRP) and the adopted MMRP for the Green Valley Specific Plan Final EIR certified March 5, 1990 prior to grading and during grading.
15	<b>Phasing.</b> Prior to issuance of building permits, all phasing plans shall be reviewed and approved by the Planning Division, and the City Engineer. Each Phase of the project shall provide adequate drainage and at least two points of access to all lots. The Phasing shall follow the Green Valley Specific Plan Phasing Plan, Figure 2-2. Sub-phases are permitted.
16	Case Road. Developer shall dedicate 15' of ROW and construct or cause to be constructed the streetlights and trail with landscaping per Figure 2-10 along project Case Road frontage as developed in phases.
17	<b>March Air Reserve Base and Perris Valley Airport.</b> Prior to building permit issuance, the conditions of approval by the Airport Land Use Commission (ALUC) letter dated August 11, 2022 shall be satisfied.
<b>Prior to Issuance of Occupancy Permits for future Tracts</b>	
18	<b>Disclosure Avigation Easement.</b> Developer shall record a disclosure on each lot and provide a disclosure to the purchaser of each lot that the project is within March Air Reserve Base influence area and Perris Valley Airport influence area. A similar disclosure shall be made in recognition of potential noise impacts from March Air Reserve Base and the avigation easement granted to the City of Perris and to the March Inland Port Airport Authority. This disclosure shall conform to the Airport Land Use Commission approval.



**Green Valley Specific Plan  
2<sup>nd</sup> Amendment Appendix 5  
Implementation Guidelines  
April, 2023**

19	<b>Disclosure Statements for Dam Inundation.</b> Developer shall record a disclosure on each lot and provide a disclosure to the purchaser of each lot that the project is within a dam inundation area and is subject to flooding in the event of a dam failure and shall provide an acknowledgement of this disclosure by each purchaser to the City.
20	<b>Disclosure Statements for Wastewater Treatment Plant.</b> Developer shall record a disclosure on each lot and provide a disclosure to the purchaser of each lot that the project is in proximity to an existing Wastewater Treatment Plant and shall provide an acknowledgement of this disclosure by each purchaser to the City.
22	<b>Active Transportation Plan.</b> All tracts are subject to the requirements of the City of Perris Active Transportation Plan dated December 8, 2020.
<b>Community Services</b>	
	The project shall annex into the Community Facilities District No. 2018-02 (Public Services)
<b>Additional Comments</b>	
1	PA 33a Park to be built by the 500 <sup>th</sup> building permit of the Phase 2 portion of GVSP (north of Watson Road: PA 30, 21, 20, 19a, 6a). See Figure 2-1 Land Use Plan for location.
2	PA 33 Paseo to be built by the 800 <sup>th</sup> building permit of the Phase 2 portion of GVSP (north of Watson Road: PA 30, 21, 20, 19a, 6a). See Figure 2-1 Land Use Plan for location, and Figure 2-10, Pedestrian Circulation for Dual Trail cross section.
a	Trail from Goetz Road along Evac Channel through PA 53 & 54, to the west of PA 33A (New River Trail Alignment) to be built by the 450 <sup>th</sup> building permit of the Phase 2 portion of GVSP (north of Watson Road: PA 30, 21, 20, 19a, 6a). See Figure 2-10, Pedestrian Circulation for Access Road and D.G. Trail cross section.
b	Design plans for the Park and Trail (Planning Areas 33 and 33a) shall be submitted to the Community Services Department for review and approval. The Trail (Planning Area 33) shall be designed as a meandering trail with fitness equipment. The Park (Planning Area 33a) is 5.1 acres and is categorized as a neighborhood park which shall be designed to include active recreational amenities, children’s play area, restroom facility, lighting, parking, landscaped area, and park furnishings.
c	All applicable access easements owned by Green Valley Recovery Acquisition shall be conveyed to city for future acceptance and maintenance upon completion of improvements
<b>Engineering</b>	
1	Subsequent Tentative Tract Maps shall be reviewed and conditioned in concurrence with this Green Valley Specific Plan Amendment and shall provide all respective backbone infrastructure improvements as determined by the City Engineer per the GVSP cross-sections along tract frontage as depicted on Figure 2-11, Street Cross Sections.

**Green Valley Specific Plan  
2<sup>nd</sup> Amendment Appendix 5  
Implementation Guidelines  
April, 2023**

<b>Prior to any Tentative Map/Planning Area Approval</b>	
2	A Traffic Impact Analysis (TIA) has been prepared as part of this Specific Plan Amendment and Environmental Impact Report Addendum. Section 2-6, Circulation Plan, of the GVSP Amendment 2 provides an overall circulation plan and cross sections (see Figure 2-11, Street Cross Sections) for all roadways depicting lane numbers and dimensions, medians, parkways, pedestrian walkways and trails. Future Tentative Tract Maps shall comply with these conditions. City Engineer, however, may require Future Tentative Tract Maps to provide a project level specific TIA to address specific points of access and traffic controls. Respectively, the developer/property owner may be required to dedicate the necessary rights-of-way and/or easements for these access points.
<b>Additional Comments</b>	
3	As part of the original approval of the GVSP, the majority of roads and easements have been dedicated to the City. To the extent any additional ROW and easements are required as part of this specific plan amendment, easements and/ or rights-of-way shall be offered for dedication to the public or other appropriate agencies and shall continue in force until the City or the appropriate agency accepts or abandons such offers. All dedications shall be free from all encumbrances as approved by the City Engineer.
4	Other than traffic related improvements, in the event that offsite property is required to provide the necessary improvements, the developer/property owner shall make a good faith effort to acquire required offsite property interests, and if he or she should fail to do so, the developer/ property owner shall, prior to submittal of the Final Map for recordation, enter into an agreement to complete the improvements. The agreement shall provide for payment by the developer/ property owner of all costs incurred by the City to acquire the offsite property interests required in connection with the subdivision. Security of a portion of these costs shall be in the form of a cash deposit in the amount given in an appraisal report obtained by the developer/ property owner (at developer/ property owner cost). The appraiser shall be approved by the City prior to commencement of the appraisal.
5	The development is within the limits of FEMA 100-year flood plain. Each tract/ planning area shall be flood proofed by elevating the pads above the 100-year water surface elevation. The developer/property owner shall file and process a CLOMR. Subsequently, the developer/property owner shall file and process a LOMR prior to issuance of any certificate of occupancy.
6	Preliminary Hydrology and Hydraulic Study and water quality provisions shall be submitted for review and approval. The Study shall be in accordance to Riverside County Flood Control and Water Conservation District (RCFCD) and FEMA regulations.
7	Basin design shall be in compliance with City of Perris and RCFCD requirements, guidelines and standards.

**Green Valley Specific Plan  
2<sup>nd</sup> Amendment Appendix 5  
Implementation Guidelines  
April, 2023**

8	Water and sewer will serve letters shall be obtained from Eastern Municipal Water District (EMWD).
9	The development is located within the limits of San Jacinto River Area Drainage Plan (ADP) for which drainage fees have been adopted by the City. Drainage fees shall be paid as set forth under the provisions of the "Rules and Regulations of Administration of Area Drainage Plan".
<b>Public Works</b>	
	The provisions contained herein are applicable to all properties within the Green Valley Specific Plan, and are intended to establish the authority, through City Council Action, to establish procedures to regulate the development of public landscaping, flood control and water quality facilities and street or public area lighting. Certain Development Plans, Tract Maps, Parcels Maps, and other Land Use Entitlement Permits may require compliance with certain City Council approved conditions of approval prior to final map recordation, issuance of a certificate of occupancy, operating permits, final building permits, or acceptance and turn-over of Improvements. These provisions are also intended to provide uniformity in the issuance of future conditions of approval for the preceding development activities.
1	<b>Dedication and/or Landscape Maintenance Easement and Landscape Easement Agreement.</b> Offer of Dedication and/or Landscape Maintenance Easement for City landscape maintenance district shall be provided as follows:
a.	Provide offer of dedication as needed to provide for full or half width Street improvements, depending upon frontage requirements of owners proposed development, including curb and gutter, sidewalk, median and off-site landscaping requirements, in compliance with the City General Plan, and Green Valley Specific Plan Circulation and Landscape Elements, including minimum public parkway distances from back of curb, for:
	<b>Local Street-</b> Sections: 2.6 and Section 4, and Figures 2-10, 2-11, 4-31
	<b>Secondary Arterial(s) (100', 128', 136')</b> : Sections 2.6 and Section 4.4, and Figures 2-10, 2-11, 4-34
	<b>Secondary Arterial (136' adj. to channel)</b> -Sections 2.6 and Section 4.4, and Figures 2-10, 2-11
	<b>Loop Road-</b> Sections 2.6 and Section 4.4, and Figures 2-10, 2-11, and Figure shown in Section 4.4
	<b>Expressway-</b> Sections 2.6 and Section 4.4, and Figures 2-10, 2-11
	<b>Arterial-</b> Sections: 2.6, and Section 4.4, and Figures 2-10, 2-11, 4-35
b	Provide for review and approval, an Offer of Dedication and certificate of acceptance, complete with legal plat map and legal description to the City of Perris. In addition, if required by the City of Perris, the Developer shall provide an additional landscape easement and Landscape easement agreement, acceptable to the City of Perris as needed to match parkway width of adjacent development, or special trail requirements.



**Green Valley Specific Plan  
2<sup>nd</sup> Amendment Appendix 5  
Implementation Guidelines  
April, 2023**

	Match distance shall be made from face of curb, and shall provide for matching, curb gutter, sidewalk and off-site landscaping requirements, if existing parkway is greater than standard City General Plan width shown on Circulation element.
2	<b>Existing Landscape.</b> Parcels fronting an existing City right-of-way or benefitting from downstream water quality basins and channels, which have been dedicated and improved with the required off-site landscape improvements benefit from said existing improvements and shall pay their fair share of maintenance costs through the appropriate maintenance District. All existing improvements shall be protected in place, and any damages caused by the proposed development shall be restored to the Satisfaction of the City, at the sole expense of the developer. Any changes necessitated by the proposed development activity, (ie. Installation of center turn pocket, deceleration lanes, etc.) will require the submittal of new off-site landscape plan for review and approval to the City of Perris.
3	<b>Landscaping Plans.</b> Three (3) copies of Construction Landscaping and Irrigation Plans for the off-site landscaping, including any medians or other landscape areas along the dedications shall be submitted to the Planning Department for approval and shall be accompanied by the appropriate filing fee. The landscape and irrigation plan shall be prepared by a registered landscape architect and conform to the requirements of Chapter 19.70 of the Municipal Code, except the following special district landscape requirements shall apply. The location, number, genus, species, and container size of the plants shall be shown. This landscape plan shall be titled to identify the proposed development, and shall be exclusive of any private property, on-site landscaping. Elements of the Landscape Plan shall include but not be limited to:
a	<b>Landscape Limits</b> – Limits of right-of-way areas or easement areas, defined by concrete mow curb, fully dimensioned, that are to be annexed into the Landscape Maintenance District. A planting palette and hardscape plan intended to meet the design intent of the Landscape Guidelines in effect for the area, including the existing Green Valley Specific Plan Landscape Design Guidelines Section 4.4; or if no such guidelines exist the design intent of neighboring development, as determined by the Public Works Department Special Districts and Storm Water Division.
b	<b>Irrigation</b> – A list of irrigation system components intended to meet the performance, durability, water efficiency, and anti-theft requirements for Special District landscape areas as determined by the Engineering Administration and Special Districts Division. Components shall include, but not be limited to Salco or equal on flexible PVC risers, Sentry Guard Cable Guard and Union Guard, and backflow Wilkens Model 375 (or equal). Controller shall include an ET based controller with weather station that is centrally controlled capable and wi-fi ready (WeatherTrak ET Pro3 Smart Controller, or equal, with Rain Sensor). At the discretion of the Engineering Administration and Special Districts Division public landscape areas utilizing no more than 6 valves/stations, programmed to irrigate consecutively, and none simultaneously, may propose the use of an alternative ET based controller with weather station that is centrally controlled

**Green Valley Specific Plan  
2<sup>nd</sup> Amendment Appendix 5  
Implementation Guidelines  
April, 2023**

	capable and wi-fi ready, such as the Weathermatic System or equal. Proposed system shall be complete with wireless weather station, aircard with flow, one year bundle service, blade antenna and flow sensor.
c	<b>Benefit Zone Quantities</b> – Include a Benefit Zone quantities table (i.e., SF of planting areas, turf, number of trees, SF. of hardscape, etc.) in the lower right hand corner of the cover sheet for off-site landscape areas, indicating the amount of landscaping the district will be required to maintain.
d	<b>Meters</b> – Each District is required to be metered separately. A meter cannot be shared between Flood Control District #1, Landscape Maintenance District #1, and/or Lighting Maintenance District 84-1, nor can a meter servicing on-site improvements be used to provide water and/or power to off-site improvements. All electrical and water meters shall be located in locations that are easily accessible to maintenance staff while not visually obtrusive in the street scene and away from street intersections. Show location of separate water and electrical utility meters intended to serve maintenance district areas exclusively. Show locations of water and electrical meter for landscape district. Show location of water and electrical meter for flood control district. Show location of electrical meter for Traffic signal and street lighting district, on respective plans. Developer shall ensure their landscape designer and civil engineer coordinate the location of meters on landscape and civil engineering plan. Final meter locations appearing on City approved off-site landscape construction plans cannot be changed without a subsequent plan amendment reviewed and approved by the City.
e	<b>Controllers</b> - The off-site irrigation controllers are to be located within the right of way (preferably within the off-site landscape area). All point of connection equipment including irrigation controller pedestals, electrical meter pedestals, and backflow preventers are to be located in locations that are easily accessible to maintenance staff while not visually obtrusive in the street scene, and away from street intersections. Backflow preventers are to be screened on at least three sides with (5) gallon plant material. The fourth side shall be open to the back of the landscape area in order to allow the backflow cage to be opened without interference with plant materials. Backflow cages shall meet the required City of Perris Engineering Standards in effect at the time of approval.
f	<b>Recycled Water</b> - If applicable. The project landscape architect shall coordinate with EMWD to verify if the site will be served with recycled water and design all irrigation and landscape plans to meet the requirements of EMWD and provide additional irrigation components as needed.
g	<b>EMWD Landscape Plan Approval</b> – The project landscape architect shall submit a copy of all irrigation plans and specifications to EMWD for approval. The project landscape architect must confirm with EMWD that the plans have been approved by EMWD and submit written proof of approval by EMWD prior to the City approving the final Landscape Plans. Until the final landscape plan has been approved by the City of Perris, the maintenance areas depicted cannot be accepted by the City for maintenance. The

**Green Valley Specific Plan  
2<sup>nd</sup> Amendment Appendix 5  
Implementation Guidelines  
April, 2023**

	developer shall coordinate both reviews to ensure acceptability of plans by both EMWD and the City of Perris, prior to approval by either agency.
h	<b>Landscape Weed Barrier</b> - Weed cloth with a minimum expected life of 10-years shall be required under all gravel, rock, or cobble areas.
i	<b>Wire Mesh and Gravel at Pull Boxes</b> - Provide wire mesh and gravel layer within valve boxes to prevent rodent intrusion.
j	<b>Slopes 3:1 Maximum</b> - Any proposed slope will not exceed a 3:1 ratio. Slopes exceeding a 3:1 ratio shall require construction of appropriate reinforcing garden walls.
k	<b>Concrete Maintenance Band at Medians and Mortar Cobble Turn Lane</b> – Provide 12” wide concrete maintenance band (safety edge) around entire median. At turn pockets provide mortared cobble creek bed, round stone sized 6” to 12”.
l	<b>Perimeter Walls Graffiti Coating</b> – Provide and install anti-graffiti coating at all perimeter walls. Acceptable products shall include Vitrocem Anti-Graffiti Coating or equal.
4	<b>Landscape Inspections.</b> The project applicant shall inform the on-site project manager and the landscape contractor of their responsibility to call for only “OFF-SITE” (including any HOA areas) landscape and irrigation inspections at the appropriate stages of construction. Inspections shall be scheduled at least two-working days (Monday through Friday) prior to actual inspection. Developer may not request inspection and turn-over inspections of partially completed “backbone” rights-of-way (segmented within the same single point of connection). Contact Public-Works Special Districts and Storm Water Division at (951) 657-3280 to schedule inspections.
	<b>Inspection #1</b> - Trenches open, irrigation installed, and system pressurized to 150 PSI for four hours
	<b>Inspection #2</b> - Soil prepared, and plant materials positioned and ready to plant.
	<b>Inspection #3</b> - Landscaping installed, irrigation system fully operational.
	<b>Inspection #4</b> A joint inspection with the Development Inspector and LMD Inspector and Applicant to request for “Start of 1 year Maintenance Period,” with all required turn-over submittal items provided to Public-Works Special Districts and Storm Water Division. This 4th Inspection, and all required corrective items must be completed prior to April 1st of the year in order for staff to recommend that the City Council consider commencement of the annual tax levy for the following fiscal year (i.e. Approved recommendations made on April 1st FY 22-23, would allow tax levy to start FY 23-24). The recommended tax levy will be applied to each parcel within the District for the requested completed point of connection landscape improvements. The Public Works Department may accept full “Point of Connection” segments of landscaping as repairs are completed within a full segment (I.e. the POC #1 improvements may be accepted by the City prior to April 1st for “Start of 1 Year Maintenance,” while incomplete improvements for POC #2 remain the maintenance responsibility of the Owner).



**Green Valley Specific Plan  
2<sup>nd</sup> Amendment Appendix 5  
Implementation Guidelines  
April, 2023**

	<p><b>Turn-Over Inspection (Inspection #5)</b> – On or about the one-year anniversary of Inspection #4, Developer shall call for an inspection to allow the City to review and identify any potential irrigation system defects, dead plants, weed, debris or graffiti; stressed, diseased, or dead trees; mulch condition, hardscape or other concerns with the landscape installation; or to accept final turn over of the landscape installation. At his sole expense, the Developer shall be responsible for rectifying system and installation deficiencies, and the one-year maintenance period shall be extended by the City until all deficiencies are cured to the satisfaction of the City. The one year maintenance period ends when all repairs are complete, and cannot be extended by the City unless a sufficient maintenance tax levy as not been received by the City (See Inspection #4 for annual tax levy process and deadlines). If in the opinion of the City’s Landscape Inspector the landscape installation is in substantial compliance with the approved landscaping plans, the irrigation and communication system is functioning as intended, and the landscape installation is found to be acceptable to the City, then the Inspector shall recommend to the City’s Special District Coordinator to accept turn- over of water and electrical accounts, wi-fi communication contracts and the entire landscape installation.</p>
5	<p><b>One Year Maintenance and Plant Establishment Period</b> -The applicant will be required to provide a one (1) year maintenance and plant establishment period, paid at the sole expense of applicant, which shall only be extended if all deficiencies and repairs are not completed, or a sufficient maintenance tax levy has not been received by the City. This one-year maintenance period commences upon the successful completion of Inspection #4 discussed above, and final approval by the City. During this one-year period the applicant shall be required to maintain all landscape areas free of weeds, debris, trash, and graffiti; and keep all plants, trees and shrubs in a viable growth condition. Prior to the start of the one-year maintenance period, the Developer shall submit a Landscape Maintenance Schedule , detailing services that are to be performed weekly within the benefit zone for the review and approval by the City’s Special Districts Division. City shall perform periodic site inspections during the one-year maintenance period. The purpose of these periodic inspections is to identify any and all items needing correction prior to acceptance by the City at the conclusion of the one-year maintenance period. Said items needing correction may include but are not limited to: replacement of dead or diseased plant materials, weeding, replenishment of mulches, repair of damaged or non-functioning irrigation components, test of irrigation controller communications, etc. During this period, the City shall begin the annual assessment of the benefit zone in preparation for the landscape installation turn-over to City maintenance staff.</p>
6	<p><b>Street/Off-Site Improvements.</b> The applicant shall submit street improvement plans, accompanied by the appropriate filing fee to the City Engineering Department. Details of treatments for off-site improvements, including lighting shall meet both the City Engineer’s technical specifications and the Green Valley Specific Plan “General</p>

**Green Valley Specific Plan  
2<sup>nd</sup> Amendment Appendix 5  
Implementation Guidelines  
April, 2023**

	Architectural Design Guidelines “Lighting” found in Sections 4.2 and 4.3. Components shall include, but not be limited to:
a	<b>Street Lighting</b> -If Street lighting is required, lighting shall meet the type, style, color and durability requirements, necessary for energy efficiency goals, maintenance and longevity of improvements of the City Engineer’s Office. As determined by the City, new streetlights may be required to be deeded to City of Perris, and not SCE. Streetlights deeded to City of Perris shall be constructed per LS-3 account billing standard, which shall include an individually metered pedestal for streetlights.
b	<b>Acceptance By Public Works/Special Districts</b> - Lighting District facilities required by the City Engineer’s Office shall be installed and fully operational and approved by final inspection by the City Engineer’s Office, and the City’s Consulting Traffic Signal Inspection Team (Riverside County TLMA) at (951) 955-6815. Prior to acceptance for maintenance of “Off-site” traffic signal and lighting facilities by the Public Works-Engineering and Administration Division/Special Districts, the developer shall contact the Public Works Special Districts Division at (951) 657-3280 to schedule delivery of all required turn-over submittal items. Prior to acceptance into Lighting District 84-1, coordinate turn-over information pertaining to Street Lights, Traffic Signal Electrical/SCE Service Meters with Wildan Financial Services, the City’s Special Districts Consulting Firm at (951) 587-3564. (i.e. Provide electrical meter number, photo of pedestal, and coordinate “request for transfer of billing information” with SCE and City for all new service meters). Developer shall pay 18-month energy charges to the City of Perris for all off-site street lighting. Call Wildan Financial Services, Inc. for amount due, and to obtain receipt for payment. Obtain a clearance form from Riverside County TLMA indicating completion of all punch list items from traffic signal construction. Submit one large format photo-copy of Traffic Signal as-built plans and timing sheets.
7	<b>Water Quality Management Plans.</b> The applicant shall submit a Preliminary and Final WQMP, accompanied by the appropriate filing fee to the Planning Department and City Engineering Department, respectively. Details for treatment control facilities shall meet both the Riverside County WQMP Design Guidelines, and the additional requirements of the Engineering and Special Districts Division intended to reduce long term maintenance costs and longevity of improvements. Components shall include, but not be limited to: <ul style="list-style-type: none"> <li>• <b>Storm Drain Screens</b>-If off-site catch basins are required by the City Engineer’s Office, connector pipe screens shall be included in new catch basins to reduce sediment and trash loading within storm pipe. Connector pipe screens shall the type, style, and durability requirements of the Public Work’s Engineering Administration and Special Districts Division.</li> <li>• <b>WQMP Inspections</b>- The project applicant shall inform the on-site project manager and the water quality/utilities contractor of their responsibility to call</li> </ul>

**Green Valley Specific Plan  
2<sup>nd</sup> Amendment Appendix 5  
Implementation Guidelines  
April, 2023**

	<p>for both “ON-SITE” and OFF-SITE” WQMP Inspections at the appropriate stages of construction. Contact CGRM at (909) 455-8520 to schedule inspections.</p> <ul style="list-style-type: none"> <li>• <b>Acceptance By Public Works/Special Districts</b>-Both on-site and off-site flood control/water quality facilities required for the project, as depicted in the Final WQMP, shall be installed and fully operational, and approved by final inspection by the City’s WQMP Consultant, CGRM. The Developer shall obtain a final Clearance Letter from CGRM indicating compliance with all applicable Conditions of Approval for the approved WQMP. The developer shall deliver the same to the Public Works-Engineering and Administration Division/Special Districts. In addition, prior to acceptance by the City, the developer shall submit a Covenant and Agreement describing on-going maintenance responsibilities for on-site facilities per the approved WQMP, to the Public Works Engineering Administration and Special Districts Division. The Public Works Engineering Administration and Special Districts Division will review and approve the Covenant and Agreement. The City shall record the same with the Riverside County Recorder’s Office, and the recorded instrument shall be returned to the City Clerk of the City of Perris for filing.</li> </ul>
8	<p><b>Flood Control District #1 Maintenance Acceptance.</b> Flood Control District facilities required by the City Engineer’s Office shall be installed and fully operational, and approved by final inspection by the City Engineer’s Office. Parcels benefitting from existing storm drain facilities, downstream water quality basins and channels, which have been dedicated and improved with the required improvements shall pay their fair share of maintenance costs through the appropriate maintenance District. Prior to acceptance for maintenance of “Off-site” flood control facilities by the Public Works-Engineering and Administration Division/Special Districts the developer shall contact the Public Works Special Districts Division at (951) 657-3280 to schedule the delivery of all required turn-over submittal items including as-built storm drain plans in electronic PDF format, one large format photo-copy of as-built plans, storm drain video report in electronic format, and hardcopy of video report with industry standard notations and still photos made during video runs (i.e. facilities sizes, off-sets or damage, facility type, dirt and debris, etc.). The flood control facilities shall be turned over in a condition acceptable to the City, and the developer shall make all necessary repairs and perform initial maintenance to the satisfaction of the City.</p>



**Green Valley Specific Plan  
2<sup>nd</sup> Amendment Appendix 5  
Implementation Guidelines  
April, 2023**

9	<p><b>Assessment Districts.</b> Prior to final map recordation for proposed tract or parcel maps, or building permit issuance, for proposed development plan review and other such land entitlement permits, developer shall deposit \$5,250 per district (or current fee at the time of annexation), for maps and development not previously annexed. Tentative Tract Maps 37816, 37817, 37818, 37262, 37223, 37722, and 36988, and 36989, were previously annexed. The process described herein applies to tract maps, parcel maps, develop plan reviews, and/or other land use entitlements proposed. Payment is to be made to the City of Perris, and the check delivered to the City Engineer’s Office. Payment shall be accompanied by the appropriate document for each district indicating intent and understanding of annexation, to be notarized by property owner(s):</p>
	<p><b>Consent and Waiver for Maintenance District No. 84-1</b> - New street lighting proposed by the project, as determined by the City Engineer</p>
	<p><b>Consent and Waiver for Landscape Maintenance District No. 1</b> – Tentative Tract Maps 37816, 37817, 37818, 37262, 37223, 37722, and 36988, and 36989, were previously annexed into LMD 1 and cover all associated landscaped water quality basins and associated swales. New off-site parkway landscape and any landscaped water quality basins, swales, etc. proposed by the project shall also be annexed to LMD 1. In addition, for new development areas fronting existing improvements the new Development shall pay its fair share of maintenance costs. All future tracts will be annexed to LMD 1 for maintenance of HOA-maintained areas in the public rights of way or public facilities in case of default or failure to maintain.</p>
	<p><b>Petition for Flood Control Maintenance District No. 1</b> - For Off-site Flood Control Facilities proposed by the project, as determined by the City Engineer. Parcels benefitting from existing storm drain facilities, downstream water quality basins and channels, shall pay their fair share of maintenance costs.</p>
	<p>Original notarized document(s) to be sent to: Daniel Louie, Wildan Financial Services, 27368 Via Industrial, #200, Temecula, CA 92590</p>
a	<p>Prior to final map recordation or final certificate of occupancy the developer shall annex into the aforementioned districts, posting an adequate maintenance performance bond to be retained by the City as required by the City Engineer. Upon receipt of deposit and Consent and Waiver Forms, the developer shall work with City to meet all required milestones for annexations.</p>
i	<p>City prepares the Engineer’s Reports which includes a description of the improvements to be maintained, an annual cost estimate and annual assessment amounts.</p>
ii	<p>Reports are reviewed and approved by the property owner. The assessment ballots will be based on these Reports.</p>
iii	<p>The Reports and corresponding resolutions are placed, for approval, on the City Council Meeting Agenda. City Council action will include ordering the assessment ballots and setting a Public Hearing for no sooner than 45 days. Property owner attendance at this City Council Meeting is not required.</p>

**Green Valley Specific Plan  
2<sup>nd</sup> Amendment Appendix 5  
Implementation Guidelines  
April, 2023**

iv	The assessment ballots are sent to the property owner and are opened by the City Clerk at the close of the Public Hearing. With a “YES” vote by the property owner the City Council can move forward with the Resolution that Confirms the Annexation. Property owner attendance at this Public Hearing is not required
v	Confirmation by the City Council completes the annexation process, and the condition of approval has been met.