

RETAIL, OFFICE, & WAREHOUSE SPACE FOR LEASE

101 Kenwood Road, Fayetteville, GA, 30214

PROJECT FEATURES & HIGHLIGHTS

- 2,591 - 11,614 SF Spec Warehouses with Drive-In Doors
- 820 - 11,614 SF Retail/Office Opportunities
- 11K SF Fully Air-conditioned Retail Spec Suite w/ Drive-In & Dock-High Doors
- Close Proximity to I-85 & Hartsfield-Jackson Airport
- Aggressive Rate and Lease Terms
- Property Recently Renovated with New Paint, Signage, Parking Lots
- Building Signage Available

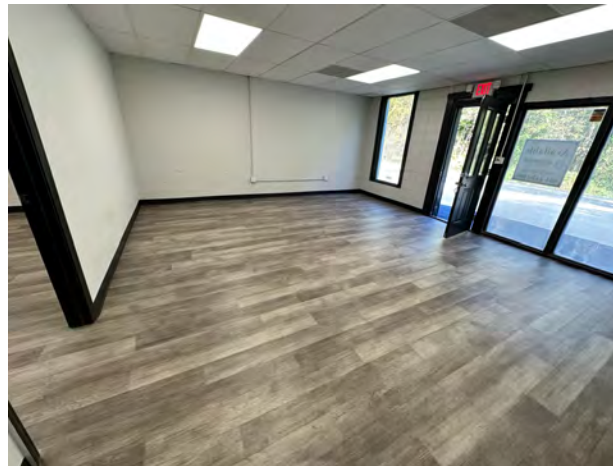
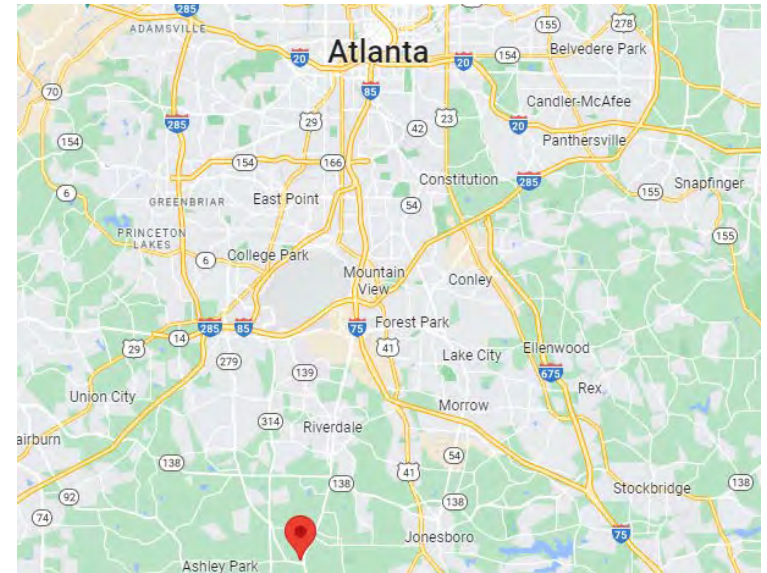

Will Middour
404.290.9713
WMIDDOUR@MIDDOURINVESTMENTS.COM

Allie Schonberg
404.242.1660
ASCHONBERG@MIDDOURINVESTMENTS.COM

Middour Investments, LLC
www.middourinvestments.com
3060 Peachtree Rd, Ste 1080 Atlanta, GA 30305

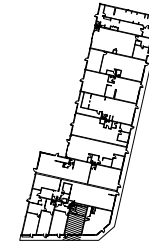

KEYPLAN

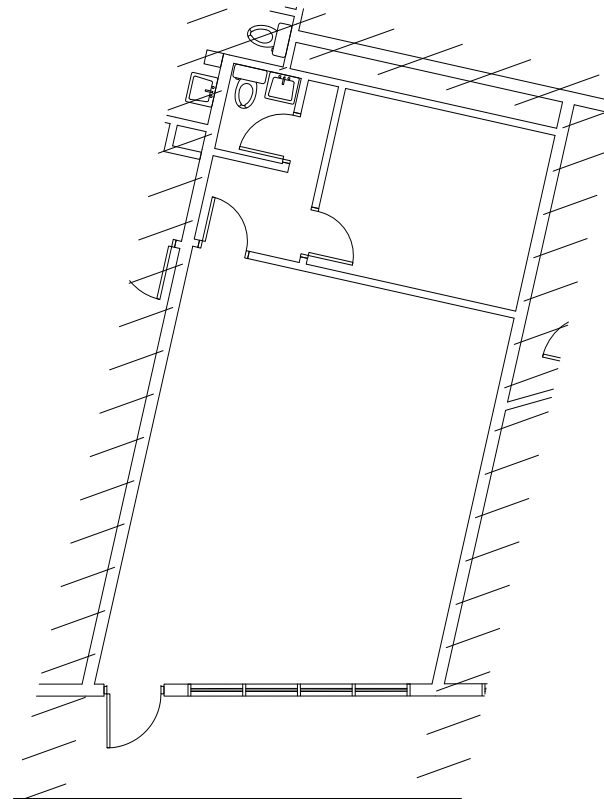

WILLIAM MIDDOUR 404.290.9713
WMIDDOUR@MIDDOURINVESTMENTS.COM
ALLIE SCHONBERG 404.242.1660
ASCHONBERG@MIDDOURINVESTMENTS.COM

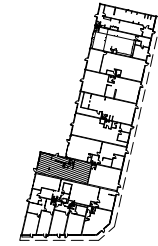

KEYPLAN

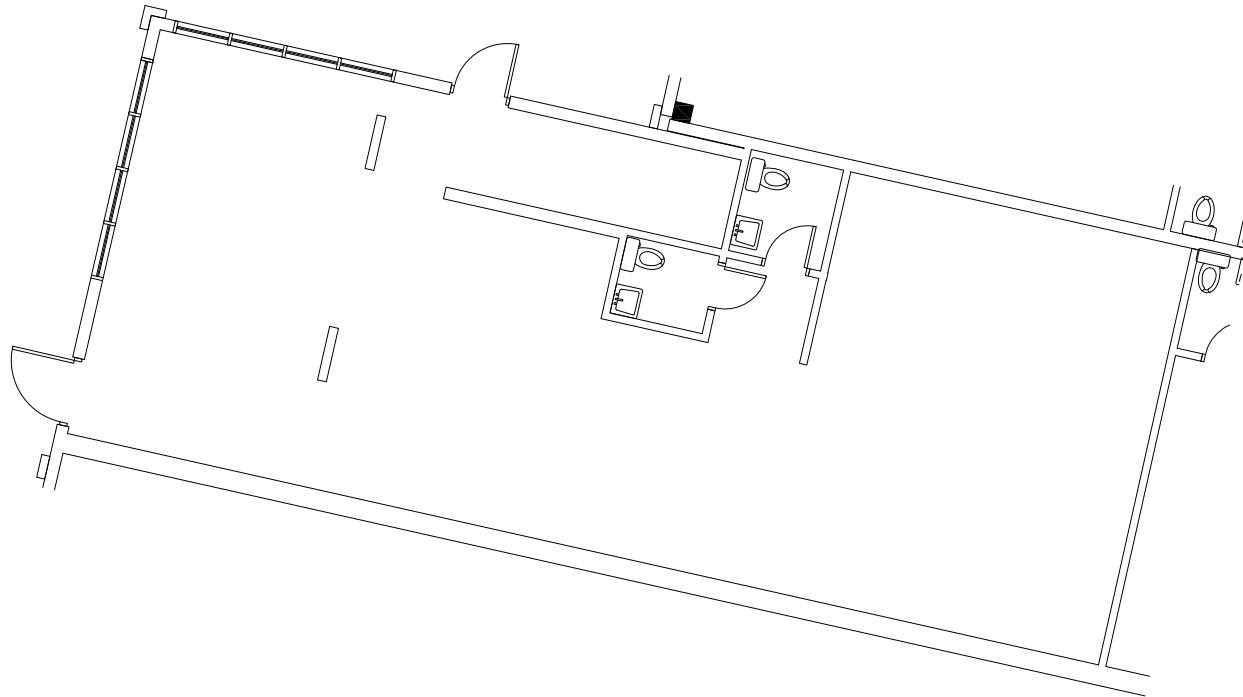

WILLIAM MIDDOUR 404.290.9713
WMIDDOUR@MIDDOURINVESTMENTS.COM
ALLIE SCHONBERG 404.242.1660
ASCHONBERG@MIDDOURINVESTMENTS.COM

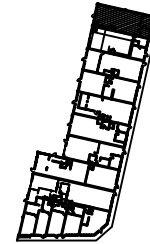

KEYPLAN

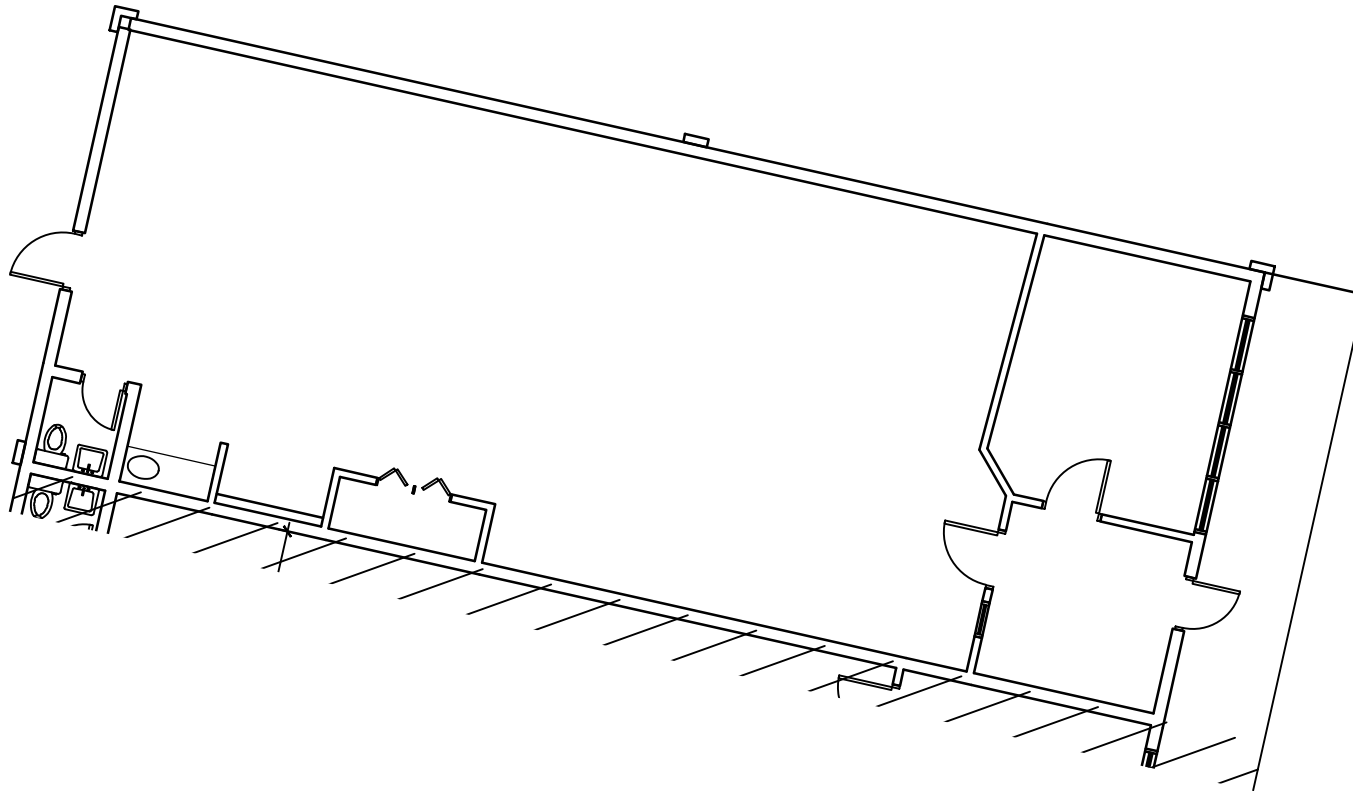

WILLIAM MIDDOUR 404.290.9713
WMIDDOUR@MIDDOURINVESTMENTS.COM
ALLIE SCHONBERG 404.242.1660
ASCHONBERG@MIDDOURINVESTMENTS.COM

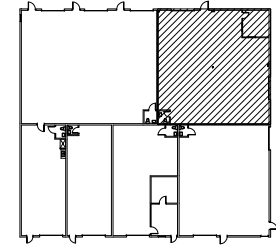
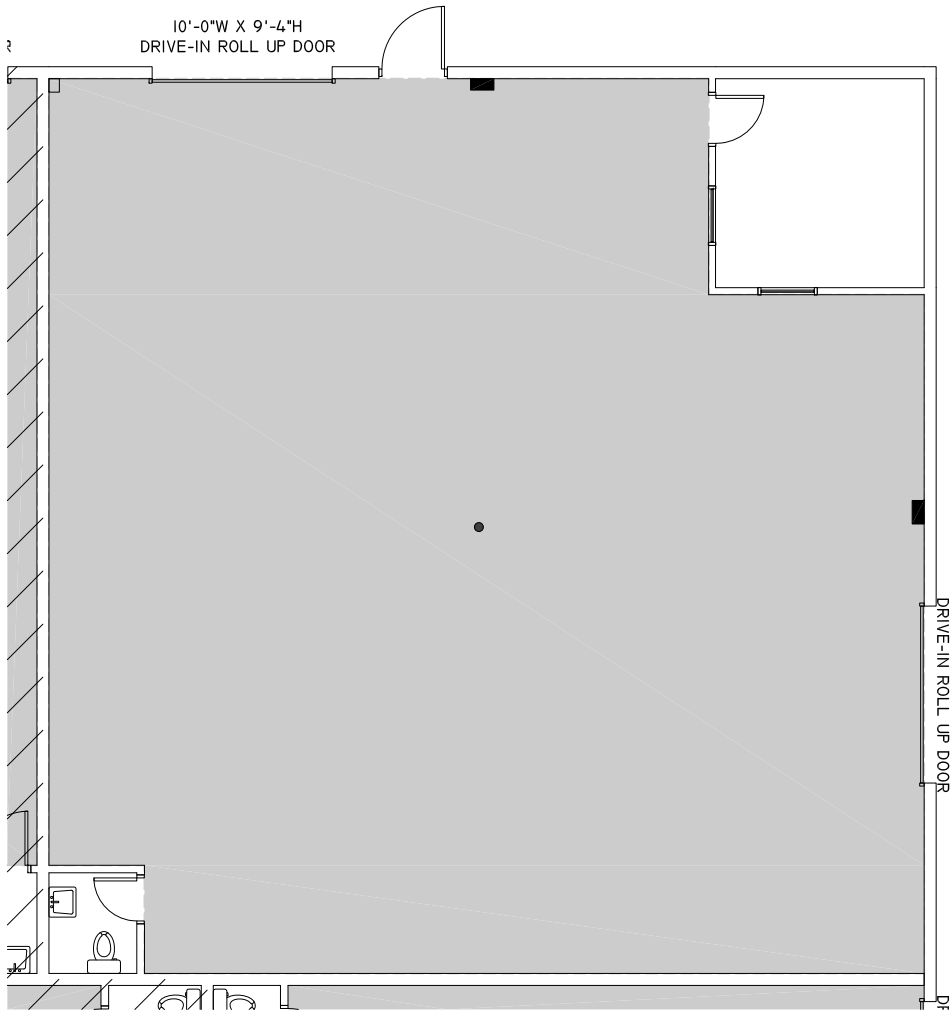

KEYPLAN



WILLIAM MIDDOUR 404.290.9713
 WMIDDOUR@MIDDOURINVESTMENTS.COM
 ALLIE SCHONBERG 404.242.1660
 ASCHONBERG@MIDDOURINVESTMENTS.COM

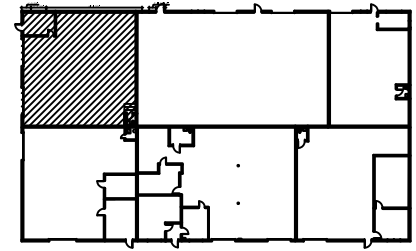

KEYPLAN

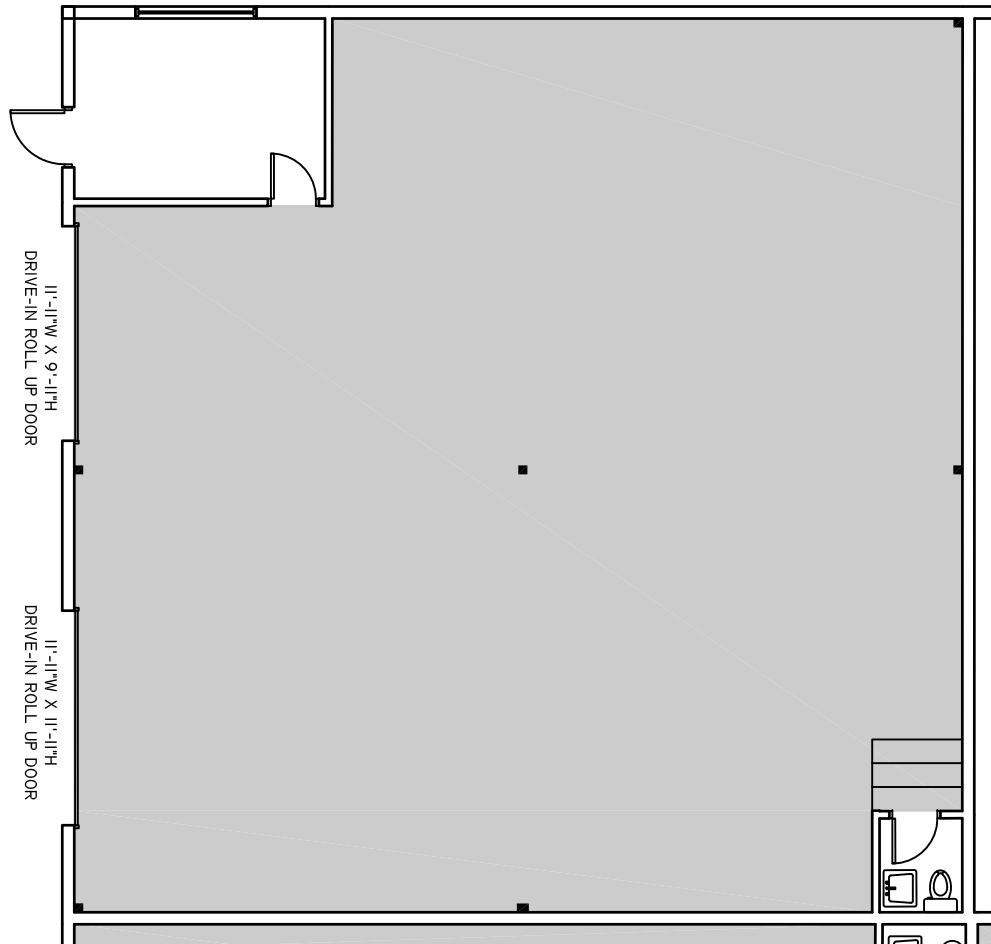

WILLIAM MIDDOUR 404.290.9713
WMIDDOUR@MIDDOURINVESTMENTS.COM
ALLIE SCHONBERG 404.242.1660
ASCHONBERG@MIDDOURINVESTMENTS.COM

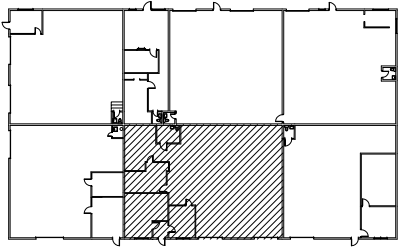
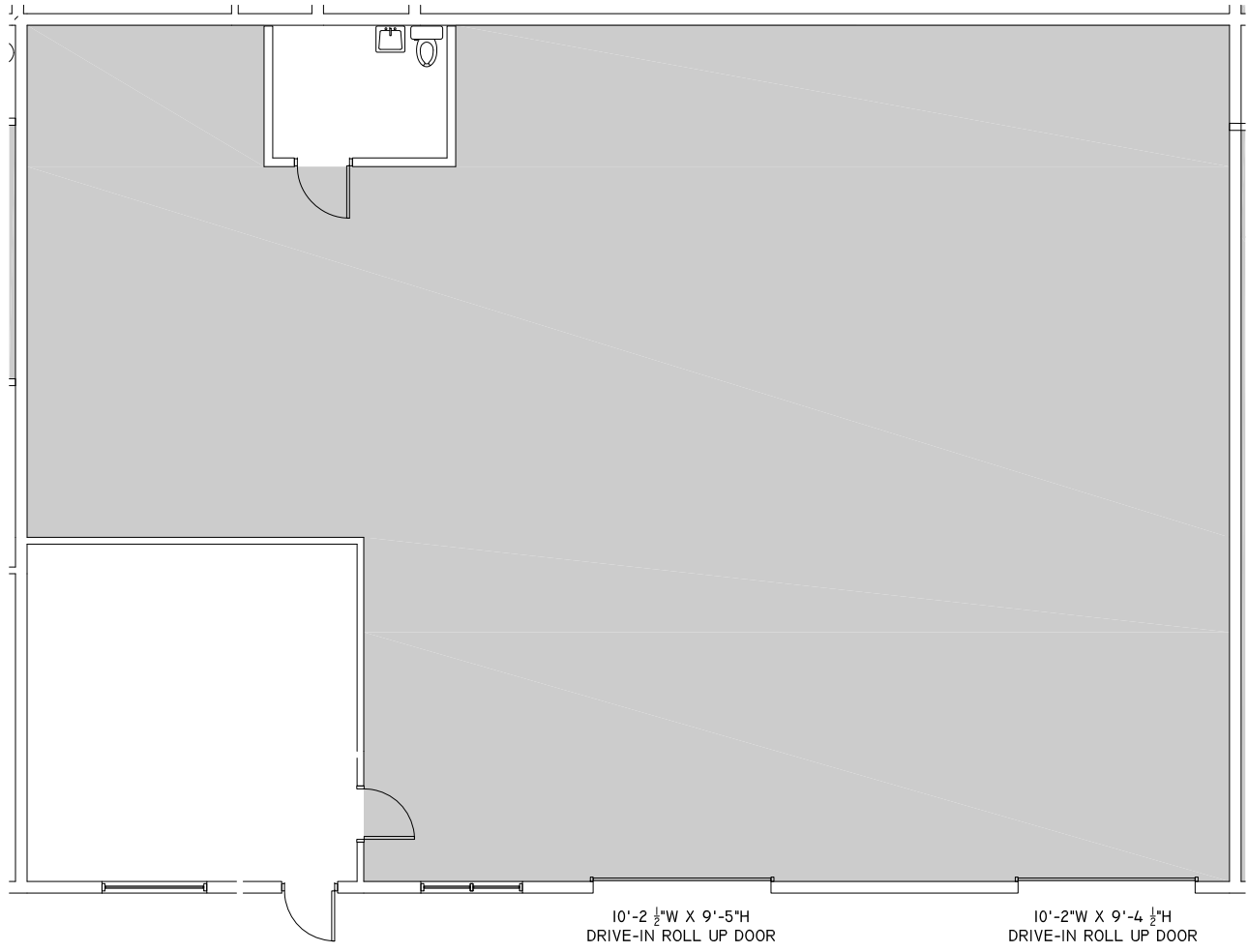

KEYPLAN



WILLIAM MIDDOUR 404.290.9713
 WMIDDOUR@MIDDOURINVESTMENTS.COM
 ALLIE SCHONBERG 404.242.1660
 ASCHONBERG@MIDDOURINVESTMENTS.COM

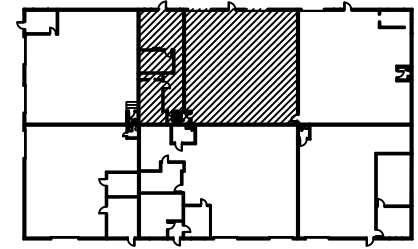
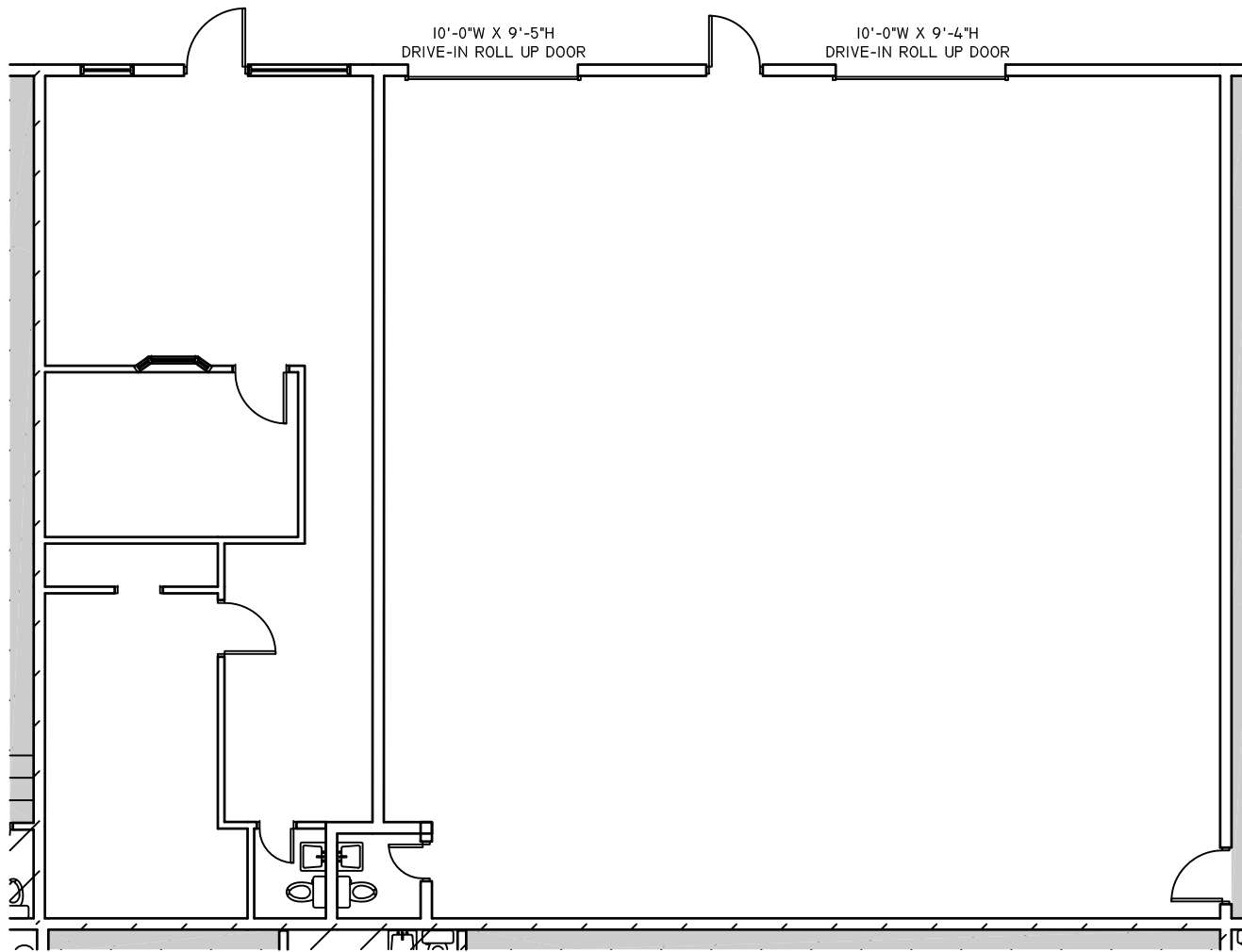

KEYPLAN



WILLIAM MIDDOUR 404.290.9713
 WMIDDOUR@MIDDOURINVESTMENTS.COM
 ALLIE SCHONBERG 404.242.1660
 ASCHONBERG@MIDDOURINVESTMENTS.COM

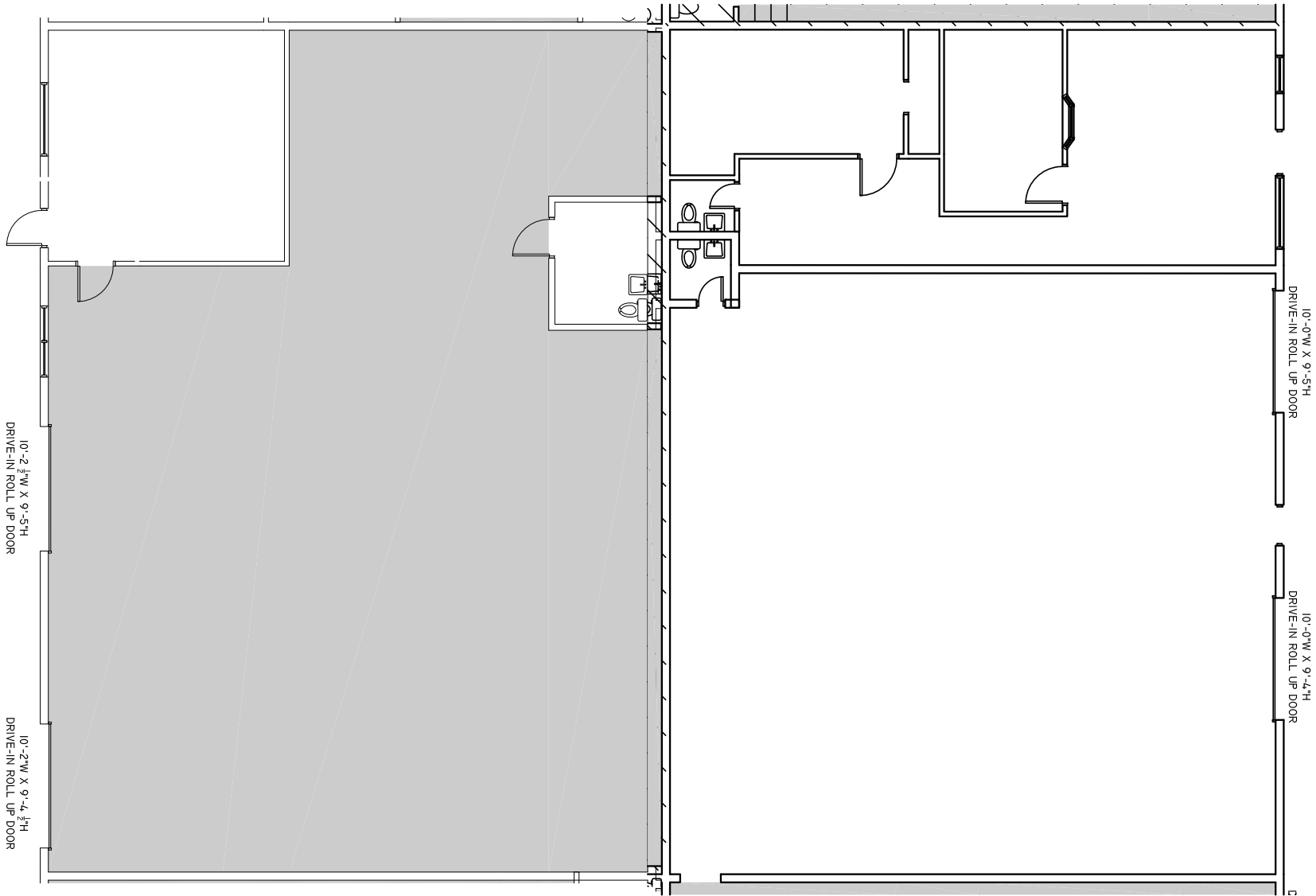

WILLIAM MIDDOUR 404.290.9713
 WMIDDOUR@MIDDOURINVESTMENTS.COM
 ALLIE SCHONBERG 404.242.1660
 ASCHONBERG@MIDDOURINVESTMENTS.COM

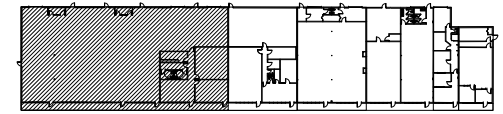

KEYPLAN

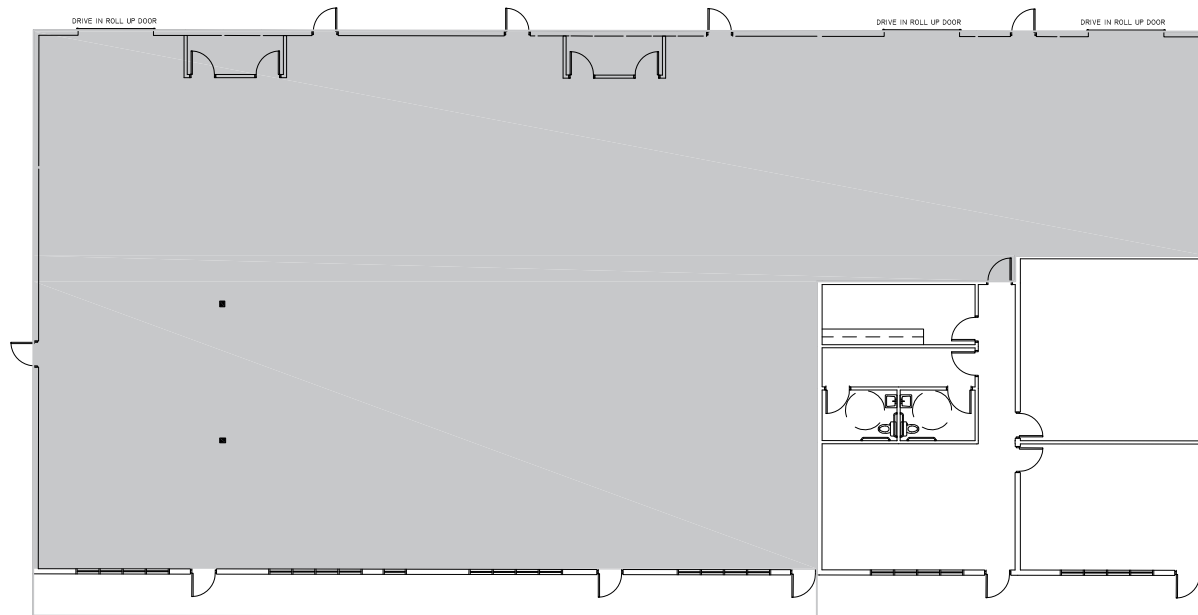

WILLIAM MIDDOUR 404.290.9713
WMIDDOUR@MIDDOURINVESTMENTS.COM
ALLIE SCHONBERG 404.242.1660
ASCHONBERG@MIDDOURINVESTMENTS.COM

