

PARK CITY

2222 & 2224 NC 54, DURHAM

BLAZE A TRAIL AT PARK CITY,
A TRANSFORMED CLASS A
OFFICE CAMPUS



NAI TRI PROPERTIES



WORKPLACE ELEVATED.

Park City is a two-building Class A Office Campus redevelopment incorporating modern enlightened design with indoor and outdoor work environments. Experience firsthand how collaborative and healthy workspaces inspire opportunities for innovation.



PARK CITY

WORKPLACE ELEVATED.

CAMPUS OVERVIEW

ADDRESS	East: 2224 Chapel Hill-Nelson Hwy. (NC 54) West: 2222 Chapel Hill-Nelson Hwy. (NC 54) Durham, NC 27713
CAMPUS SIZE	~151,000 RSF Two Buildings 14.99 Acres
AVAILABLE	East: 77,274 RSF West: 4,509 - 64,673 RSF Up to 141,947 RSF contiguous
RENTAL RATE	\$28.50 PSF, Full Service
PARKING RATIO	Approximately 4 spaces per 1,000 SF
TRAFFIC	22,000 average vehicles per day on NC 54
TELECOM	Spectrum and Frontier both offer fiber services
FEATURES	Building and monument signage opportunities Extensive indoor and outdoor amenities (See campus advantages page for details)



PARK CITY | CENTRALLY CONNECTED

 RDU Airport
8 Miles



THE HUB

BOXYARD
RTP

Buzzybakes Bakeshop
Beyu Caffé
Fullsteam RTP
Lawrence BBQ
Bulkogi
Wonderpuff Cotton Candy
Meat & Graze



Downtown
Durham
8 Miles



RTP

PARK
CITY

Walgreens
Williams's Gourmet Kitchen
McDonalds
AutoZone
La Cocina Latina
Wendy's
Bojangles
Crab Sea
Tortilleria La Miguelena
Café Meridian Catering
Jamaica Jamaica
Cook Out
92 Korean Chicken
La Recette Patisserie
Papa Johns Pizza

POINTS OF INTEREST

Research Triangle Park	Adjacent
NC 54	Fronts
NC 55	.2 Miles
I-40	.4 Miles
I-885/NC 147	2 miles
I-540	5 miles
RDU International Airport	8 miles
Research Talent Pipeline:	
Duke University	9 miles
NC State University	16 miles
UNC-Chapel Hill	10 miles

Captain D's
Vittles at the PARK
Akashi Sushi
Carniceria Mexicana
Falafel 54
Taco Bell
Arby's
Pizza Hut



Chapel Hill
10 Miles

Chick-fil-A
Starbucks
Subway
Sushioki
FedEx
Dollar Tree
Food Lion
Thai China Buffet
Hibachi 88
Golden Corral

PARK CITY

CAMPUS ADVANTAGES

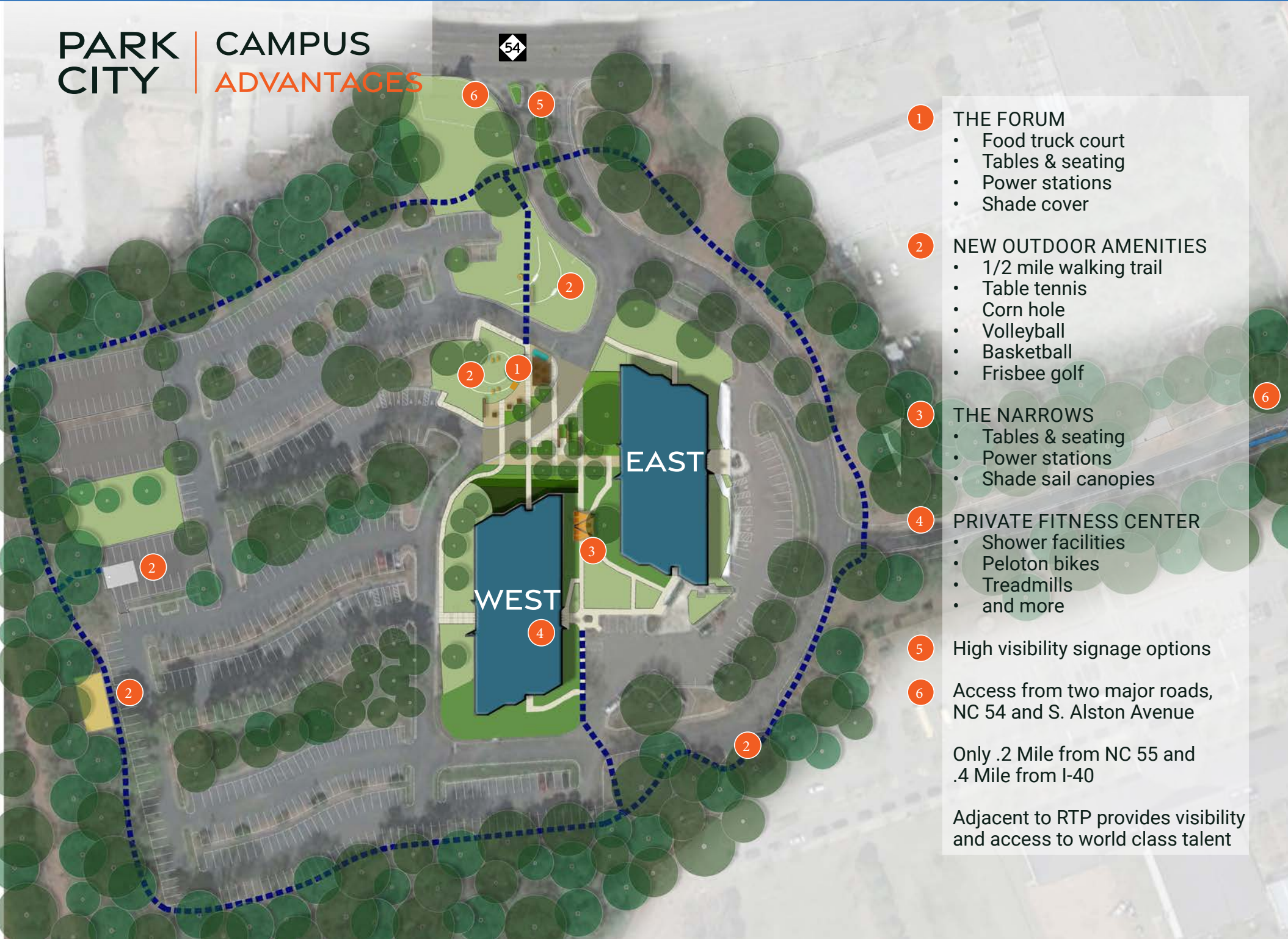

- 1 THE FORUM
 - Food truck court
 - Tables & seating
 - Power stations
 - Shade cover

- 2 NEW OUTDOOR AMENITIES
 - 1/2 mile walking trail
 - Table tennis
 - Corn hole
 - Volleyball
 - Basketball
 - Frisbee golf

- 3 THE NARROWS
 - Tables & seating
 - Power stations
 - Shade sail canopies

- 4 PRIVATE FITNESS CENTER
 - Shower facilities
 - Peloton bikes
 - Treadmills
 - and more

5 High visibility signage options

6 Access from two major roads, NC 54 and S. Alston Avenue

Only .2 Mile from NC 55 and .4 Mile from I-40

Adjacent to RTP provides visibility and access to world class talent

PARK CITY | CONNECT & COLLABORATE

COLLABORATION ELEVATED.

Collaborative and healthy workspaces inspire opportunities for **innovation**.

The Park City campus offers purposeful workplace extensions outside the typical office walls.

Gather at The Forum for food trucks, games, and shade.

A place to **plug in** laptops for group huddles. Or a place to **unplug** and get the creative juices flowing.

DRAMATIC ENTRIES AND
BUILDING SIGNAGE



**POWER UP OR
POWER DOWN**
BETWEEN BUILDINGS



**RECHARGE AT
THE FORUM**



**MODERN
LOBBIES**



PARK CITY | FLEXIBLE FLOORPLANS

PARK CITY WEST

1ST FLOOR: 15,243 RSF Available

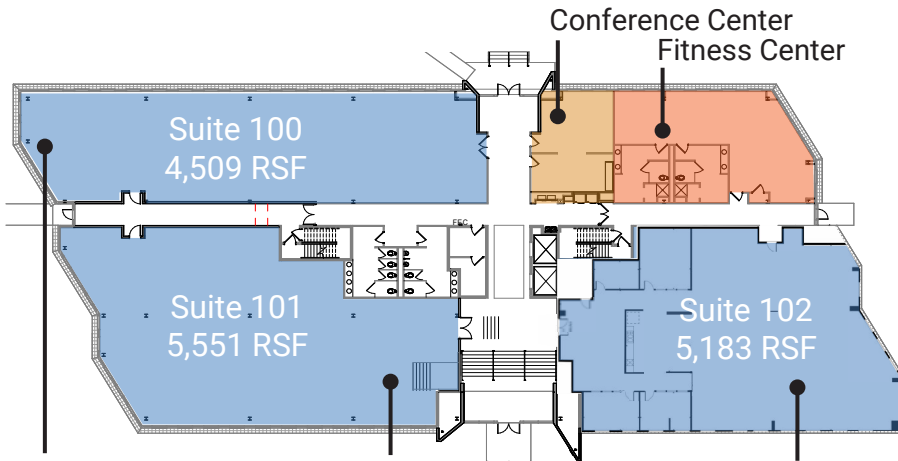

CLICK OR SCAN FOR VIRTUAL TOUR

CLICK OR SCAN FOR VIRTUAL TOUR

CLICK OR SCAN FOR VIRTUAL TOUR

2ND FLOOR: 9,846 RSF Available

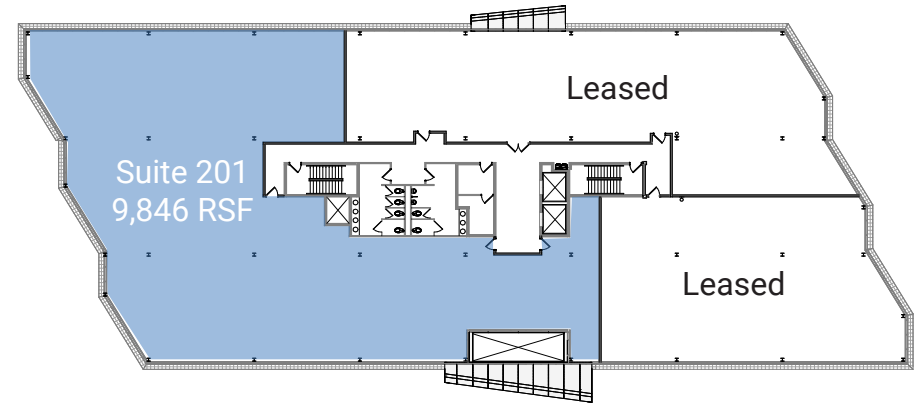

3RD FLOOR: 19,792 RSF Available

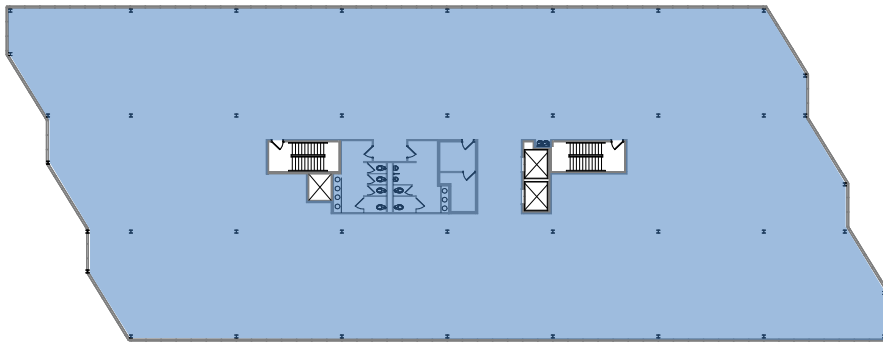

4TH FLOOR: 19,792 RSF Available

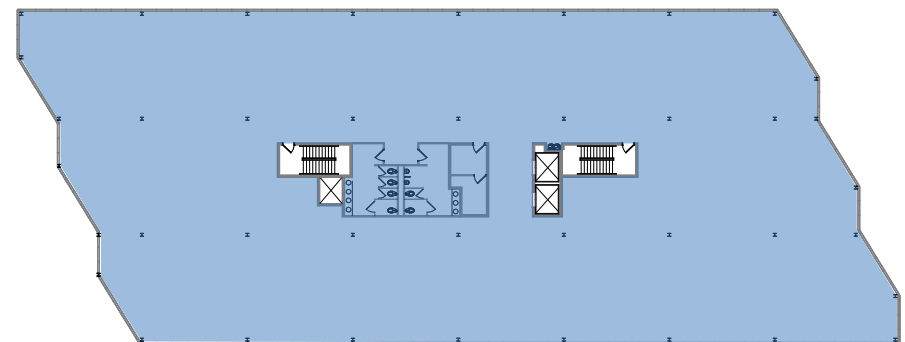

TOTAL AVAILABLE: 64,673

1ST FLOOR: 18,261 RSF Available

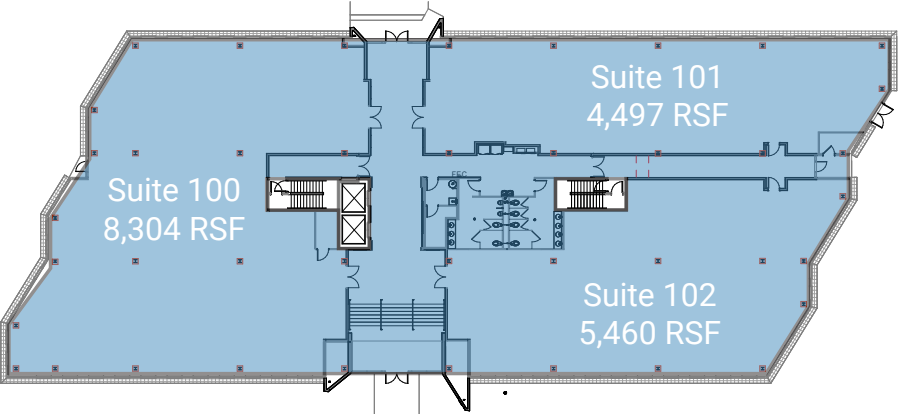

2ND FLOOR: 19,495 RSF Available

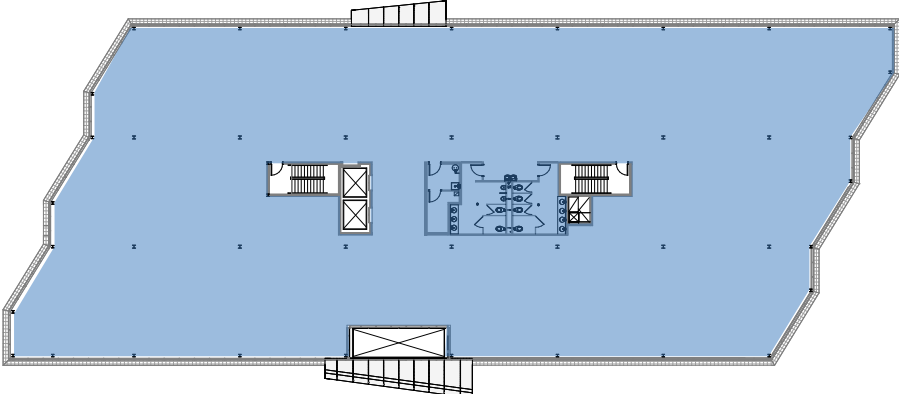

3RD FLOOR: 19,772 RSF Available

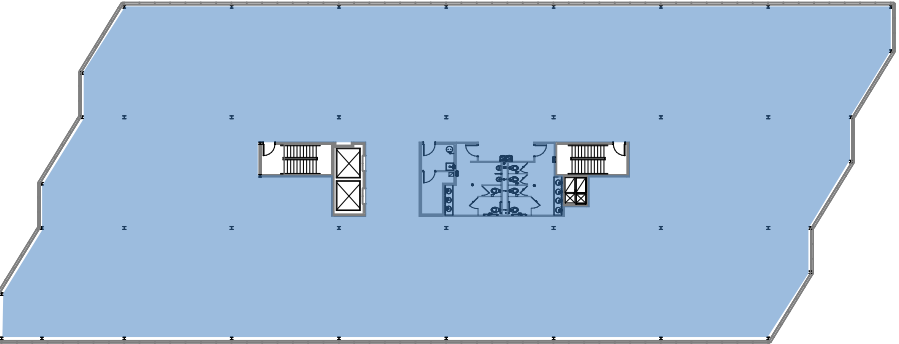

4TH FLOOR: 19,746 RSF Available

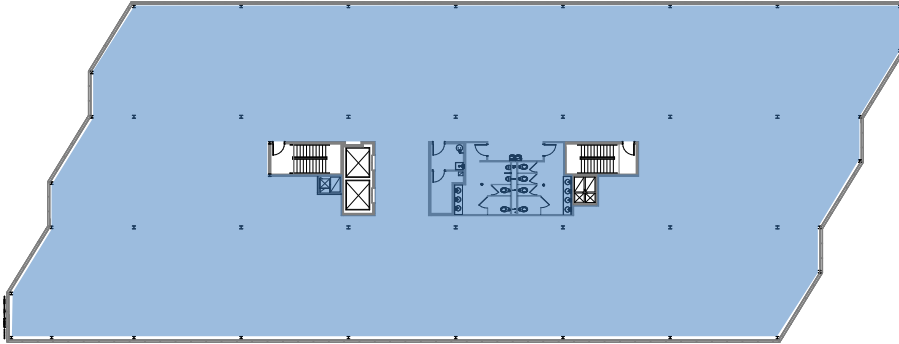

TOTAL AVAILABLE: 77,274 RSF Available

PARK CITY | ACCESS TO WORLD RENOWNED TALENT AND INNOVATION

Be part of the Triangle engine that fuels innovation.

Located adjacent to Research Triangle Park, Park City will attract talent and diverse industries to collaborate and support an economy known for world-renowned research and technology.

And proximity to three top-tier research universities, including Duke University, NC State University, and UNC-Chapel Hill, provides an edge to hiring leading talent.

TARGETED INDUSTRIES Contribution to Gross Regional Product*

LIFE SCIENCES
\$9.8 billion

TECHNOLOGY
\$14.6 billion

CLEANTECH
\$4.6 billion

ADVANCED MANUFACTURING
\$2.2 billion

AGTECH
\$1.2 billion

*Data Source: RTRP



RESEARCH TRIANGLE PARK QUICK FACTS

#1
Largest Research Park in USA

55,000
Workers

300+
Companies

\$6 Billion
Combined Annual Research Investments

3
Top Tier University Talent Pools

PARK CITY | CONVENIENT AMENITIES

Surrounded by convenient amenities, this area continues to grow. Below is a sampling of amenities all within 1 mile:

RESTAURANTS

92 Korean Chicken
Akashi Sushi
Arby's
Backyard BBQ Pit
Barrel Culture Brewing
Benetis
Beyu Caffé
Bigs at the Park
Bojangles
Bulkogi
Buzzybakes Bakeshop
Café Meridian & Catering Company
Captain D's
Carniceria Mexicana
Chef Chick's Bakery
Chick-fil-A
Chosun Ok BBQ
Cook Out
Crab Sea
Dimsum Asian Bistro
Dominos Pizza
El Dorado Mexican
Falafel 54
Fullsteam RTP
Golden Corral
Hardee's
Hibachi 88
Jamaica Jamaica
Jimmy's Famous Hot Dogs

La Cocina Latina
La Recette Patisserie
Lawrence BBQ
McDonald's
Meat & Graze
Mexicali Street Tacos & Burrito Bar
Papa Johns Pizza
Pizza Hut
Sarah's Empanadas
Starbucks
Subway
Sushioko
Tobacco Wood Brewing Co Taproom
Taco Bell
Tacos Junior
Tandoor Indian
Thai 55
Thai China Buffet
Thai Star NC
The Glass Jug Beer Lab RTP
True Flavors Diner
Vittles at the PARK
Waffle House
Wendy's
William's Gourmet Kitchen
Wonderpuff Cotton Candy

BANKS

First Horizon Bank
PNC Bank

HOTELS

Candlewood Suites RTP
Comfort Inn RTP
DoubleTree Suites
Econo Lodge RTP
Extended Stay America RTP
La Quinta Inn & Suites
Red Roof Inn
Residence Inn RTP
Sonesta Select RTP

PARKS & WELLNESS

Barkyard Dog Park
Burn Boot Camp
Chiropractic Health Solutions
CrossFit RTP
Dentistry at the Park
Emerald Pond Park
Fit Lab Studios
Hidden Park and Playground
Integro Health
Ju Wellness and Body Sculpting
Living Well Centre
Passport Health RTP
Trainers Corner Institute
Triangle Restoration Dentistry
United Thai Boxing & MMA
Upward Change Health Services

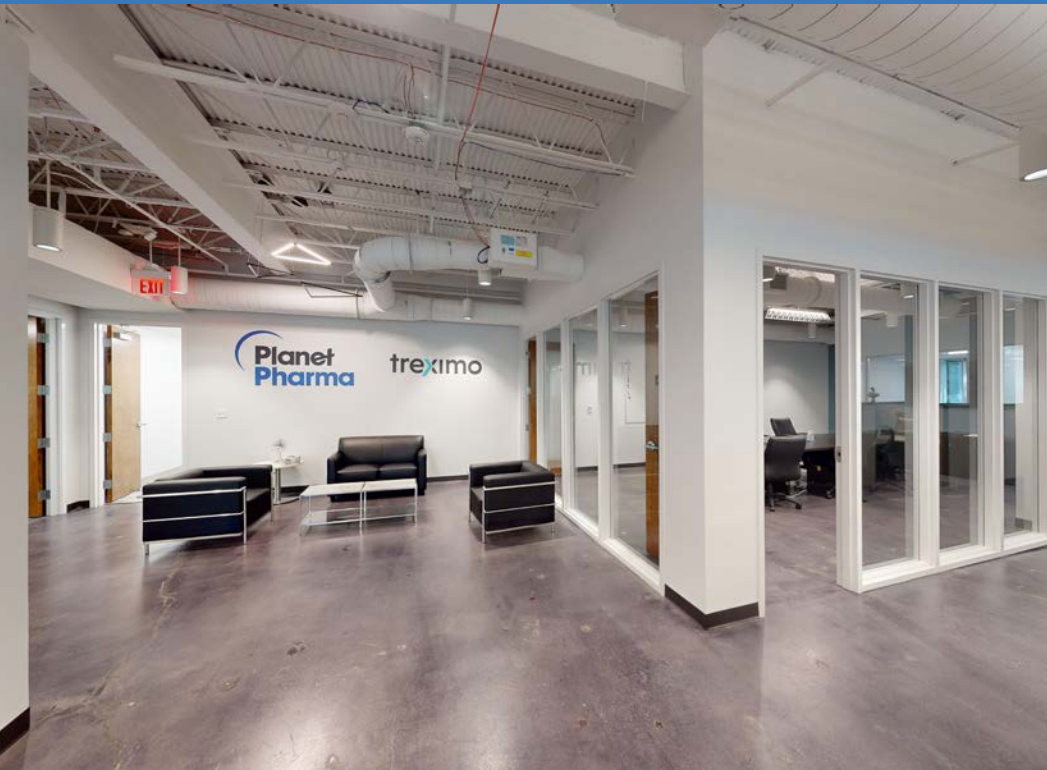

PARK CITY

FOR MORE INFORMATION CONTACT:

Robin Roseberry Anders, SIOR

919.369.6713

randers@triprop.com

Greg Sanchez, SIOR

919.281.2321

gsanchez@triprop.com

Emily Pfeiffer

252.945.9240

epfeiffer@triprop.com

NAITRI PROPERTIES

5425 Page Road, Suite 100

Durham NC 27703

919.941.5745

triprop.com

NO WARRANTY OR REPRESENTATION, EXPRESS OR IMPLIED, IS MADE AS TO THE ACCURACY OF THE INFORMATION CONTAINED HEREIN, AND THE SAME IS SUBMITTED SUBJECT TO ERRORS, OMISSIONS, CHANGE OF PRICE, RENTAL OR OTHER CONDITIONS, PRIOR SALE, LEASE OR FINANCING, OR WITHDRAWAL WITHOUT NOTICE, AND OF ANY SPECIAL LISTING CONDITIONS IMPOSED BY OUR PRINCIPALS NO WARRANTIES OR REPRESENTATIONS ARE MADE AS TO THE CONDITION OF THE PROPERTY OR ANY HAZARDS CONTAINED THEREIN ARE ANY TO BE IMPLIED.