

INCLUDED

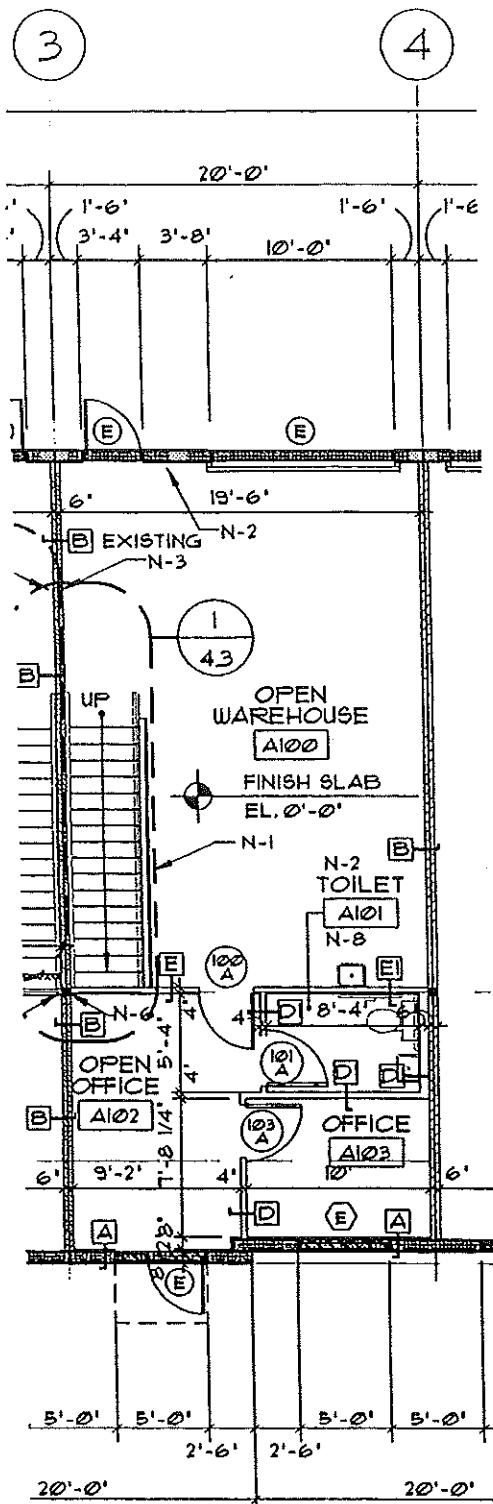

PLAN - LEVEL ONE

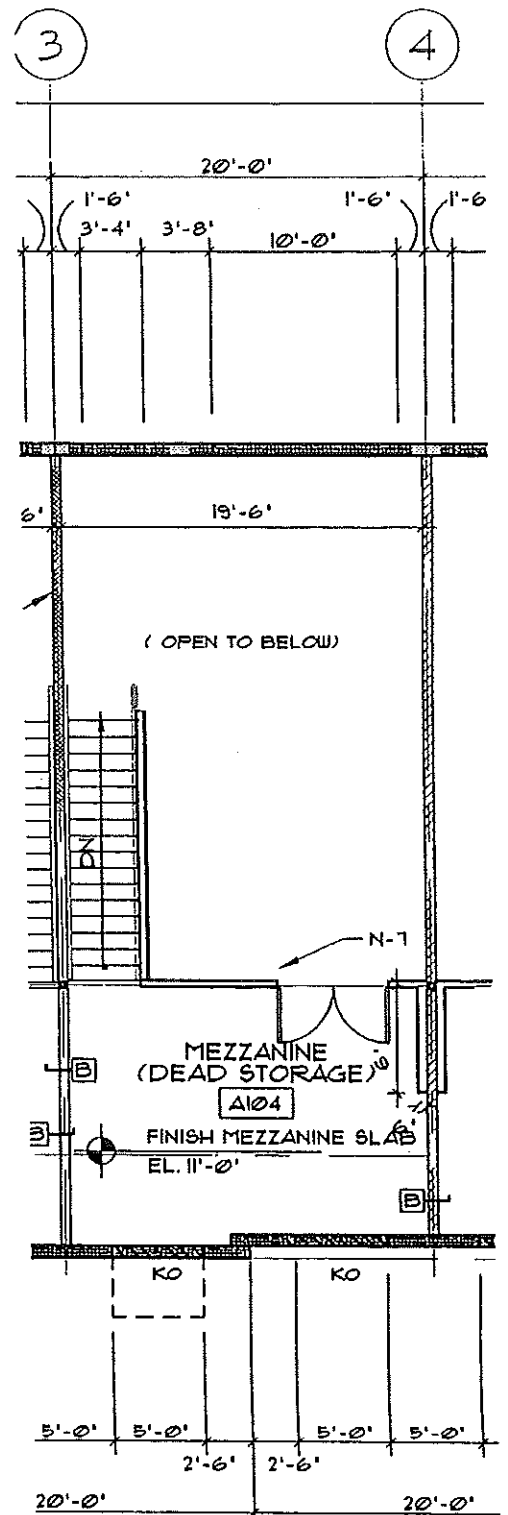

PLAN - LEVEL TWO

SQUARE FOOT CALCULATIONS - TYPE I			
AREA	SQ. FT.	%	REMARKS
WAREHOUSE	602		
OFFICE	291		
MEZZANINE	296		
LOWER LEVEL-(OFFICE + WAREHOUSE)	893		
GROSS (OFFICE, WAREHOUSE, MEZZANINE)	1199		
% OF MEZZANINE TO LOWER LEVEL		33	
% OF OFFICE TO GROSS		15.8	OFFICE AREA LESS 56 SQ. FT. OF TOILET AREA

ALL CALCULATIONS ARE TAKEN FROM OUTSIDE OF THE BUILDING SHELL TO THE CENTER LINE OF THE PARTING WALL

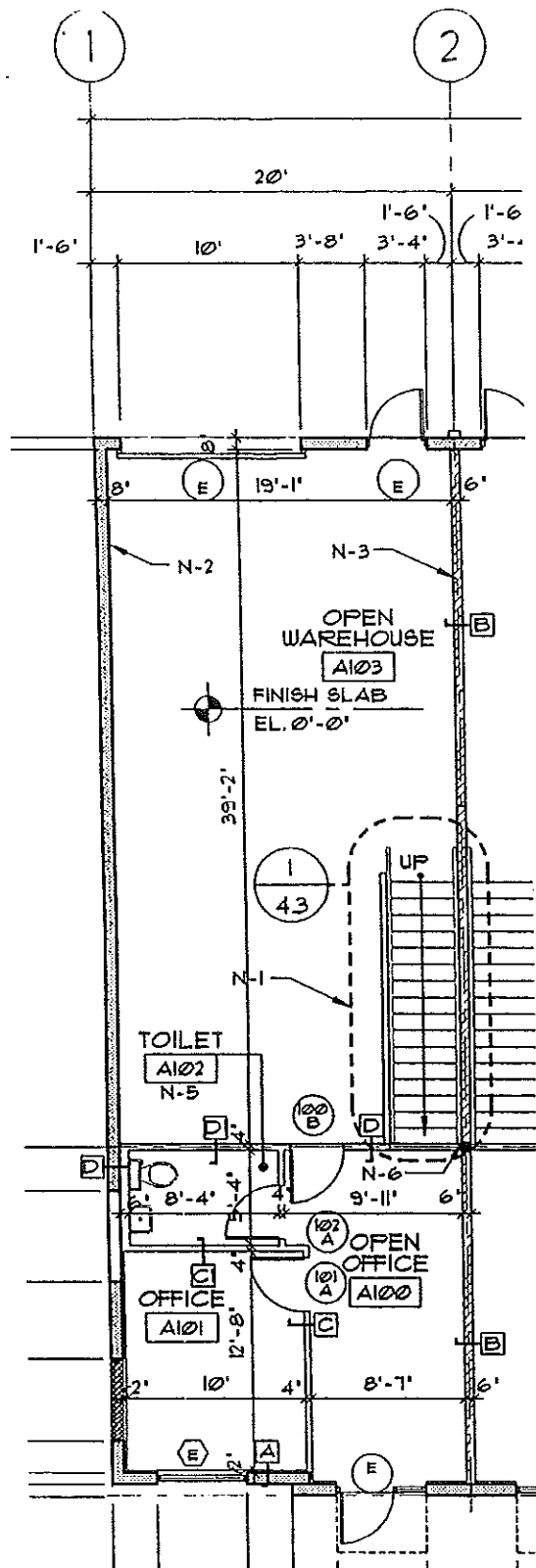

PLAN - LEVEL ONE

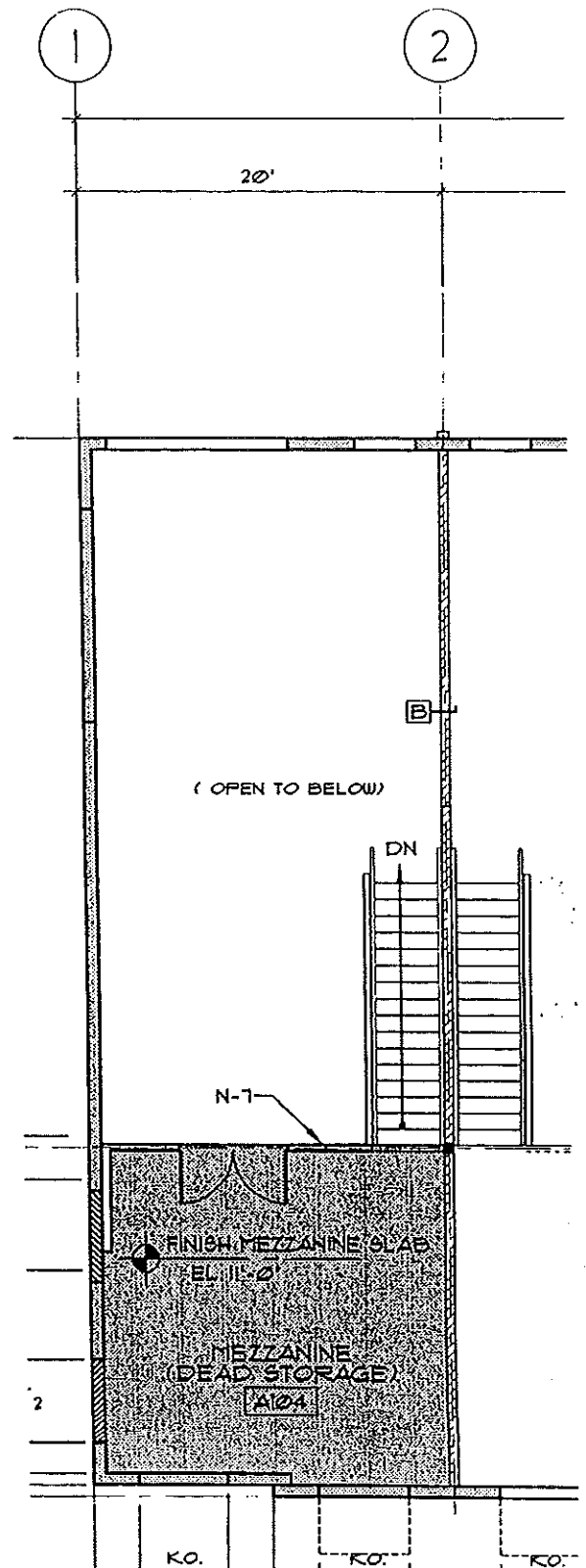

PLAN - LEVEL TWO

SQUARE FOOT CALCULATIONS - TYPE 2			
AREA	SQ. FT.	%	REMARKS
WAREHOUSE	803		
OFFICE	320		
MEZZANINE	396		
LOWER LEVEL (OFFICE + WAREHOUSE)	1193		
GROSS (OFFICE, WAREHOUSE, MEZZANINE)	1599		
% OF MEZZANINE TO LOWER LEVEL		320	
% OF OFFICE TO GROSS		21.01	OFFICE AREA LESS 55 SQ. FT. OF TOILET AREA

ALL CALCULATIONS ARE TAKEN FROM OUTSIDE OF THE BUILDING SHELL TO THE CENTER LINE OF THE PERIMETER WALL

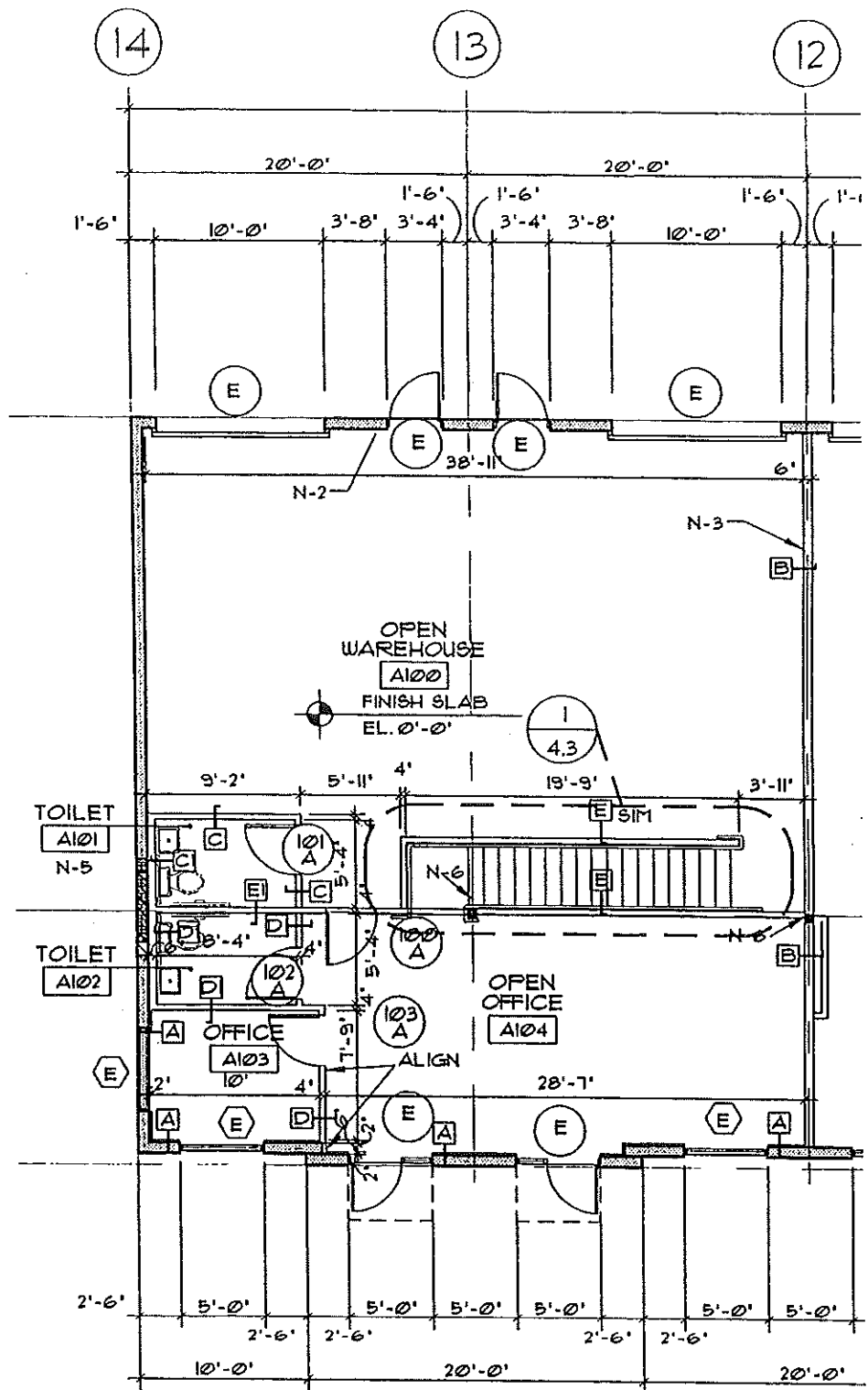

PLAN - LEVEL ONE

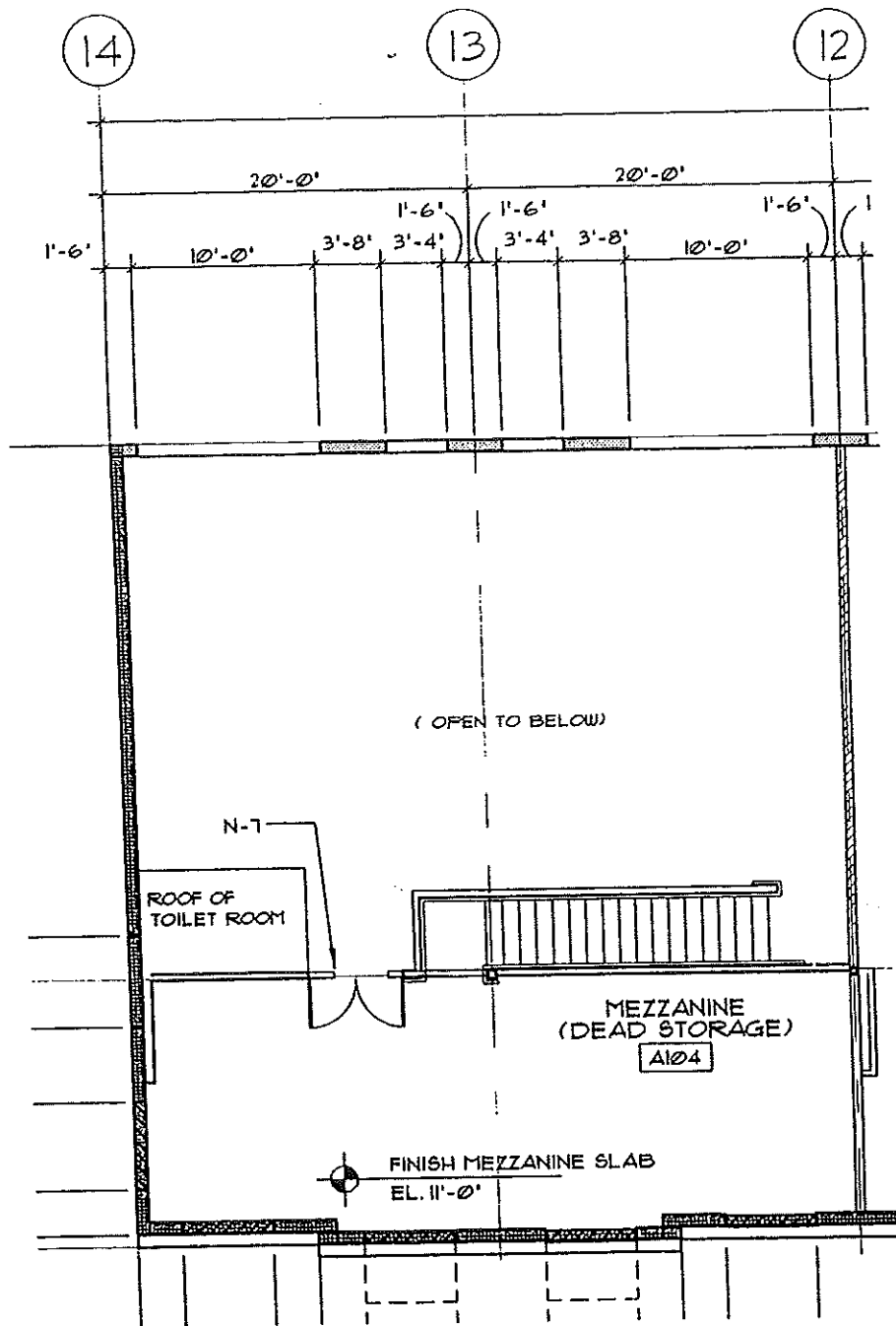

PLAN - LEVEL TWO

SQUARE FOOT CALCULATIONS - TYPE 3			
AREA	SQ. FT.	%	REMARKS
WAREHOUSE	1200		
OFFICE	575		
MEZZANINE	806		
LOWER LEVEL (OFFICE + WAREHOUSE)	1,775		
GROSS (OFFICE, WAREHOUSE, MEZZANINE)	2,581		
% OF MEZZANINE TO LOWER LEVEL		37.8	
% OF OFFICE TO GROSS		22.0	OFFICE AREA LESS 89 SQ. FT. OF TOILET AREA

ALL CALCULATIONS ARE TAKEN FROM OUTSIDE OF THE BUILDING SHELL TO THE CENTER LINE OF THE DEMISING WALL

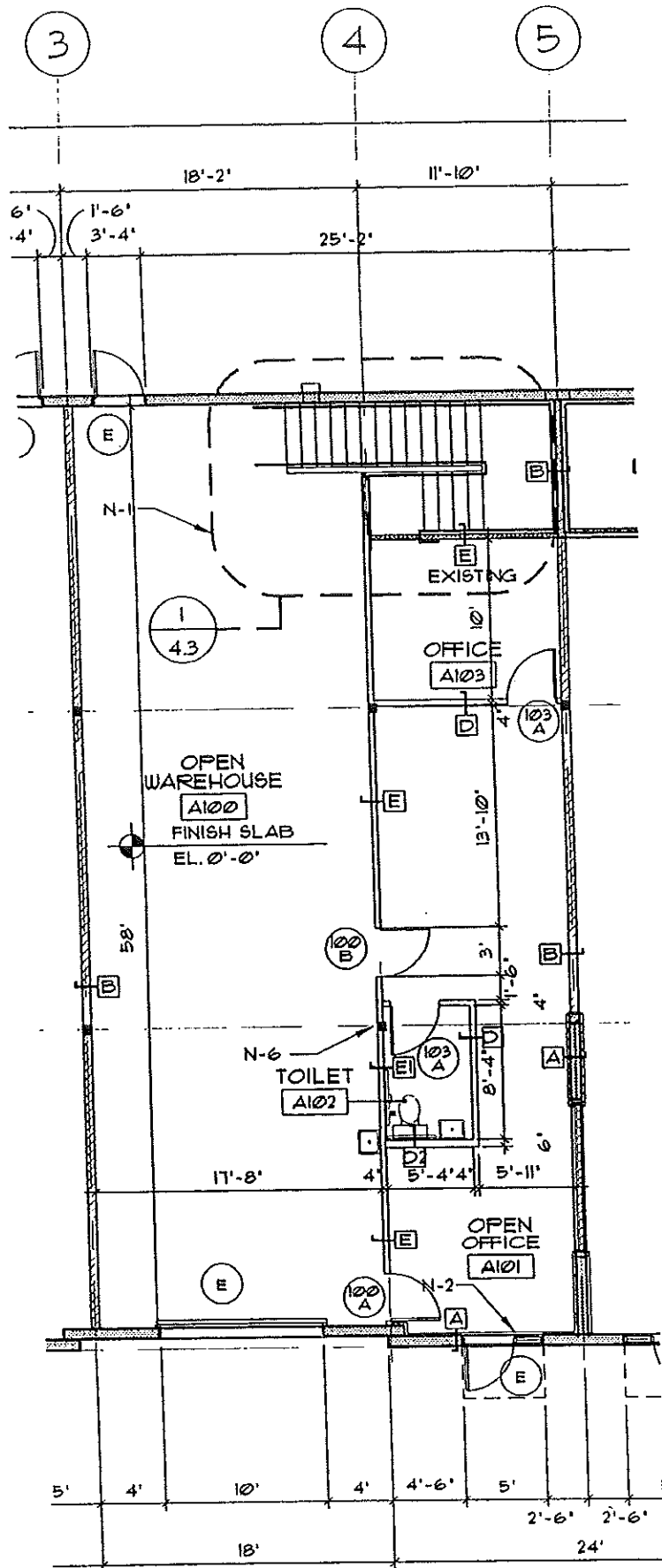

PLAN - LEVEL ONE

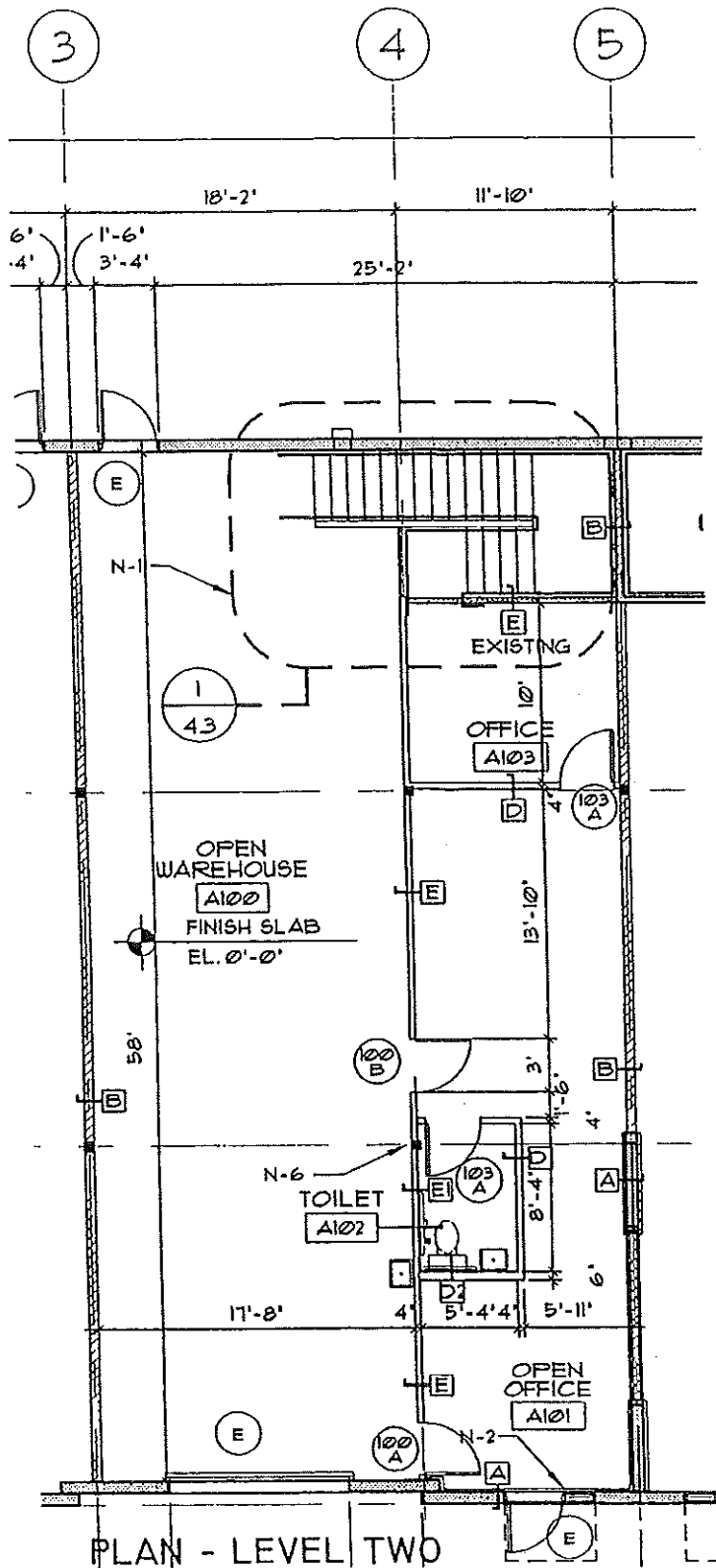

PLAN - LEVEL TWO

SQUARE FOOT CALCULATIONS - TYPE 4			
AREA	SQ. FT.	%	REMARKS
WAREHOUSE	1755		
OFFICE	605		
MEZZANINE	64		
LOWER LEVEL (OFFICE + WAREHOUSE)	1660		
GROSS (OFFICE, WAREHOUSE, MEZZANINE)	2424		
% OF MEZZANINE TO LOWER LEVEL		32.6	
% OF OFFICE TO GROSS		27.8	OFFICE AREA LESS 55 SQ. FT. OF TOILET AREA

ALL CALCULATIONS ARE TAKEN FROM OUTSIDE OF THE BUILDING SHELL TO THE CENTER

TYPE 4 - FIGURE TWO

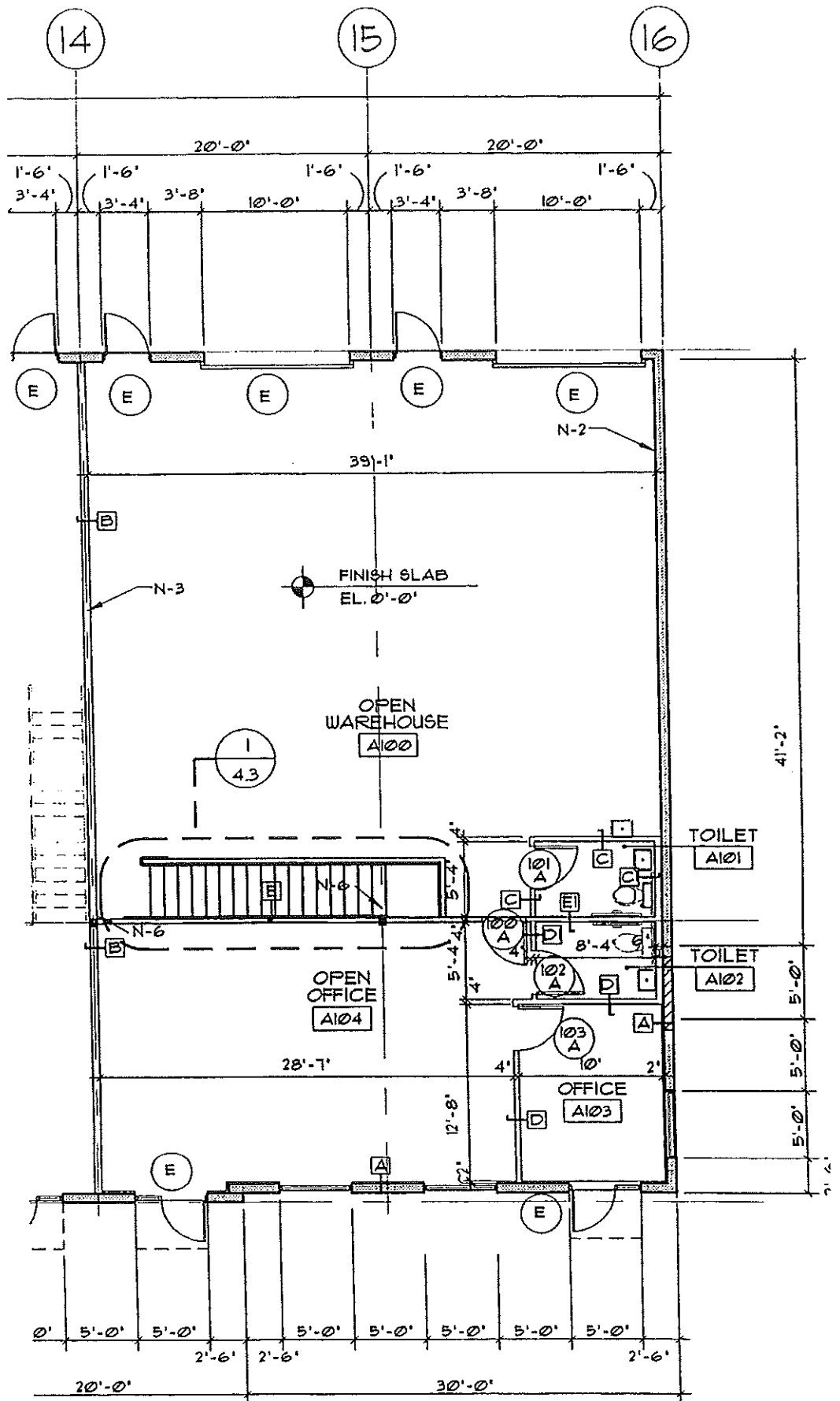

PLAN - LEVEL ONE



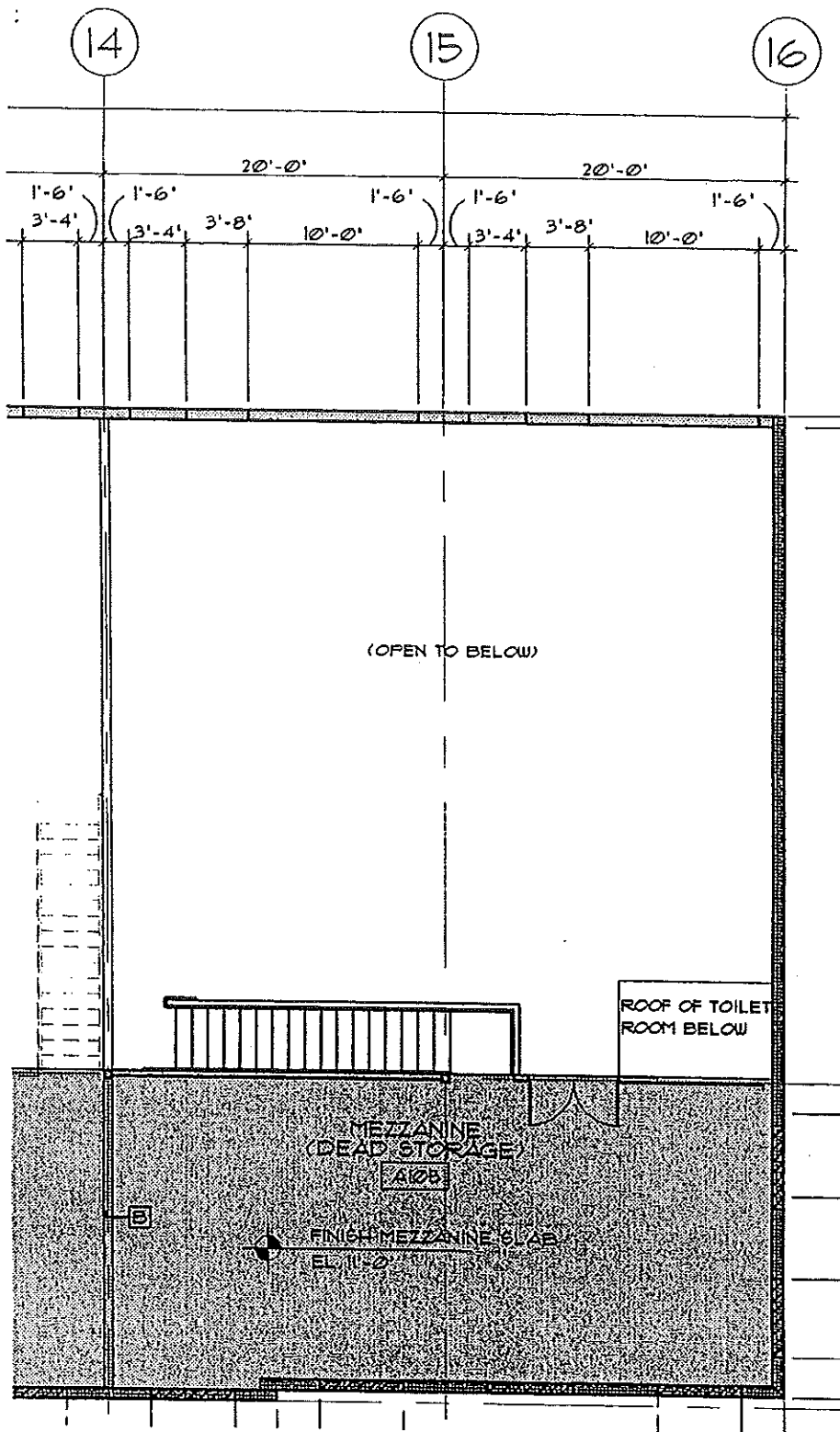

PLAN - LEVEL TWO

SQUARE FOOT CALCULATIONS - TYPE 4			
AREA	SQ. FT.	%	REMARKS
WAREHOUSE	160		
OFFICE	116		
MEZZANINE	161		
LOWER LEVEL (OFFICE & WAREHOUSE)	2360		
GROSS (OFFICE, WAREHOUSE, MEZZANINE)	3167		
% OF MEZZANINE TO LOWER LEVEL		33.0	
% OF OFFICE TO GROSS		22.0	OFFICE AREA LESS 55 SQ. FT. OF TOILET AREA

ALL CALCULATIONS ARE TAKEN FROM OUTSIDE OF THE BUILDING SHELL TO THE CENTER LINE OF THE DEMISING WALL.

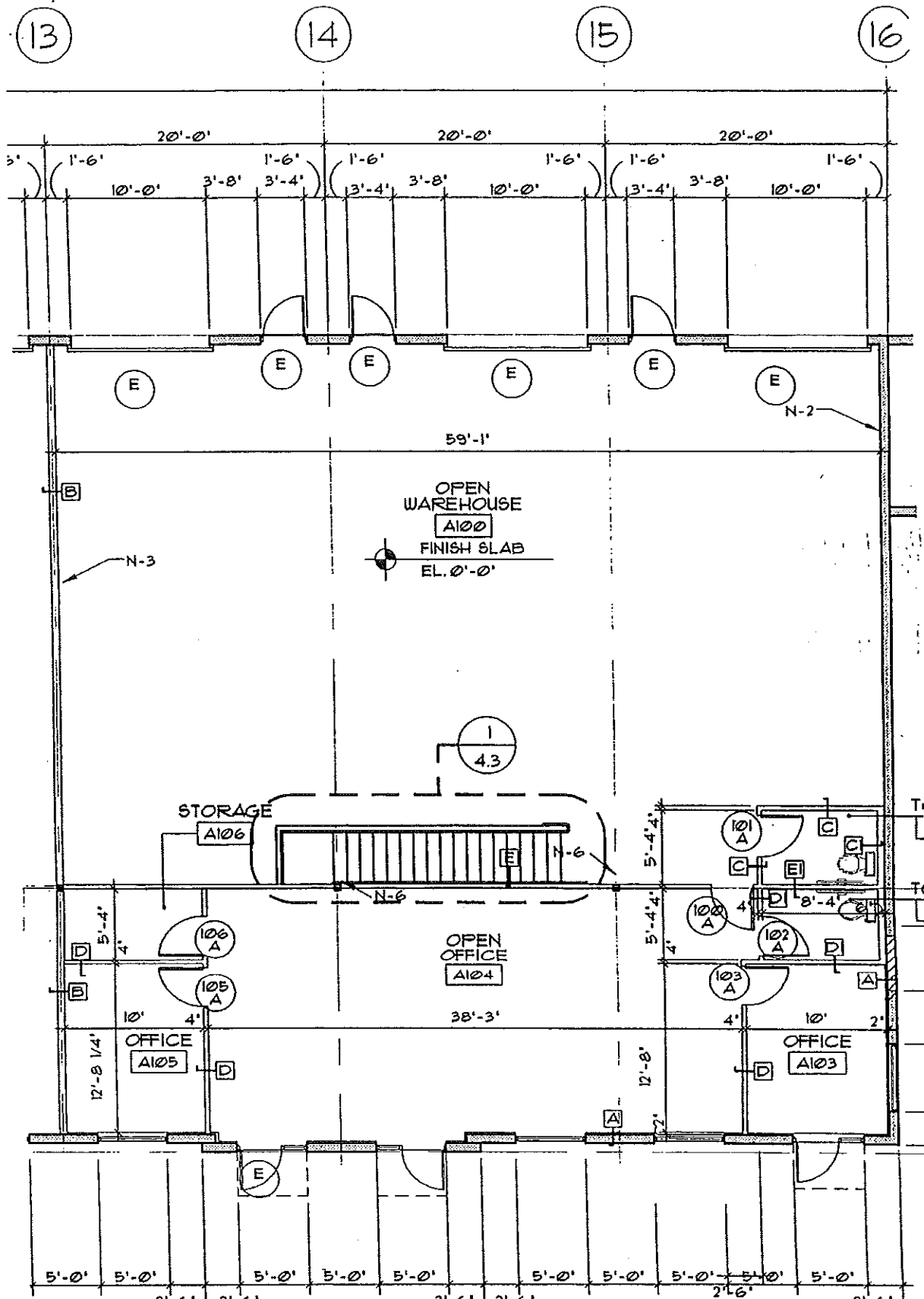

PLAN - LEVEL ONE

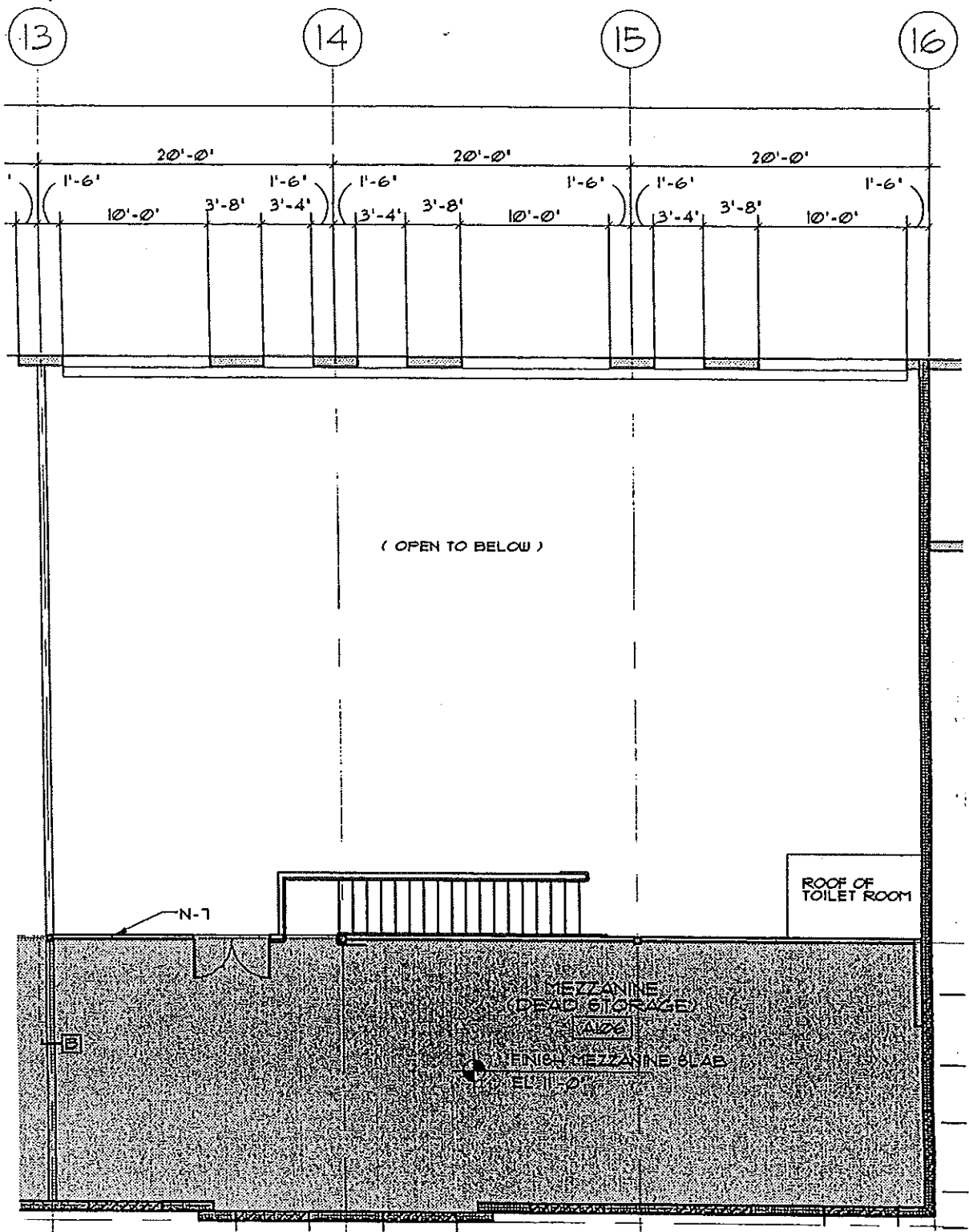

PLAN - LEVEL TWO

SQUARE FOOT CALCULATIONS - TYPE 6			
AREA	SQ. FT.	%	REMARKS
WAREHOUSE	2398		
OFFICE	1719		
MEZZANINE	1920		
LOWER LEVEL (OFFICE + WAREHOUSE)	3513		
GROSS (OFFICE, WAREHOUSE, MEZZANINE)	4,163		
% OF MEZZANINE TO LOWER LEVEL		33.3	
% OF OFFICE TO GROSS		23.5	OFFICE AREA LESS 35 SQ. FT. OF TOILET AREA

ALL CALCULATIONS ARE TAKEN FROM OUTSIDE OF THE BUILDING SHELL TO THE CENTER LINE OF THE DEMISING WALL.

TYPE 6 - FIGURE TWO

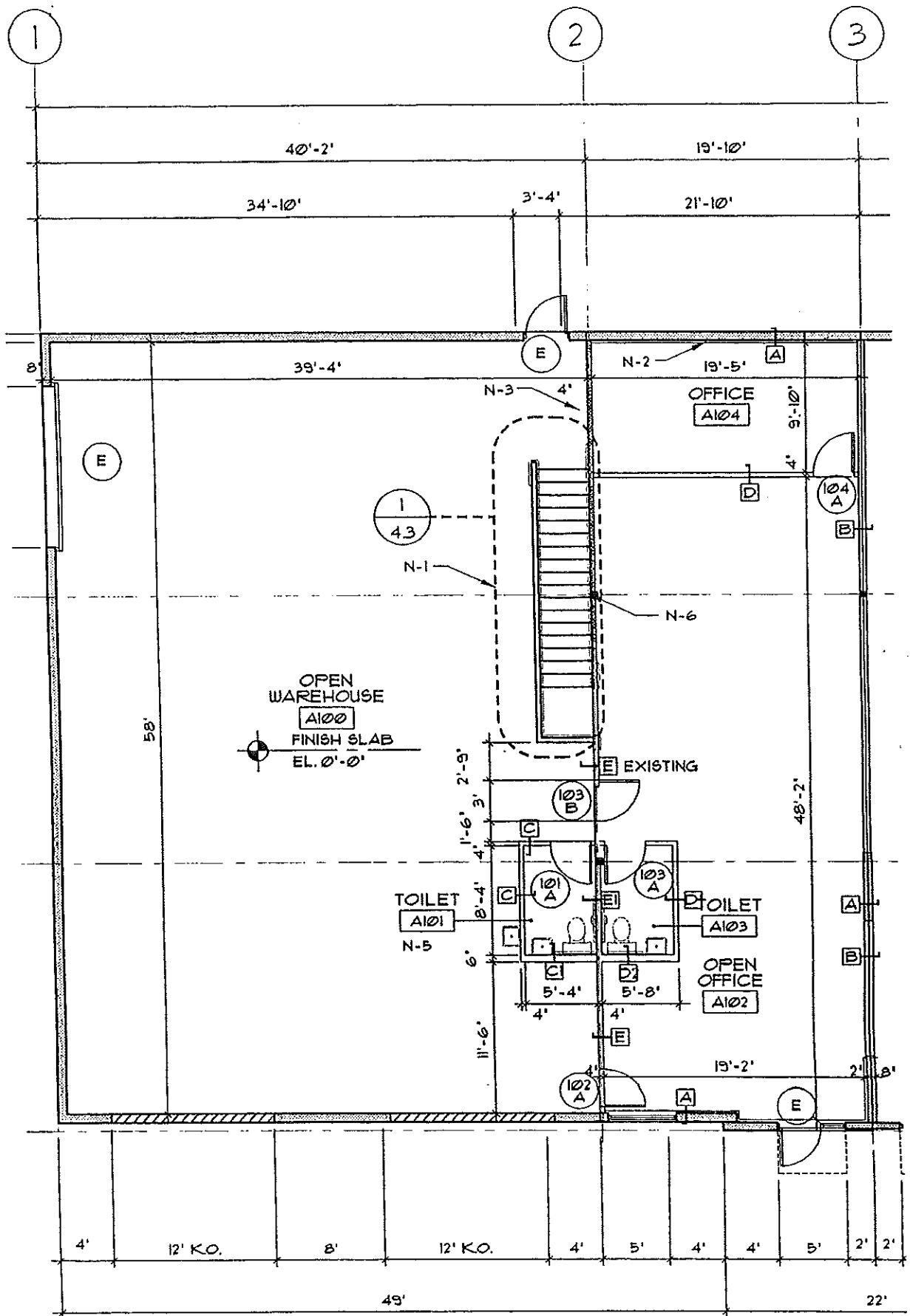

PLAN - LEVEL ONE

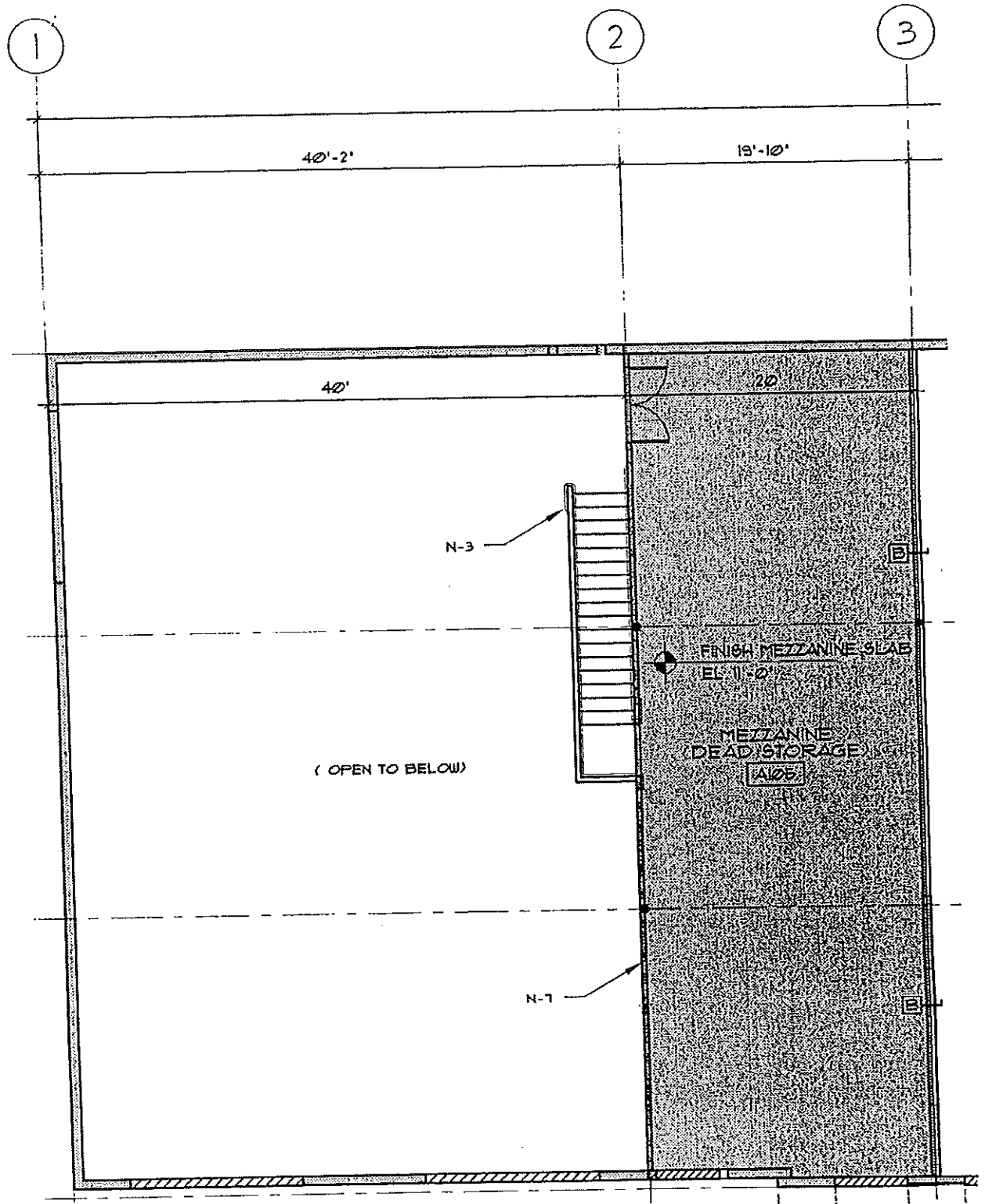

PLAN - LEVEL TWO

SQUARE FOOT CALCULATIONS - TYPE 7			
AREA	SQ. FT.	%	REMARKS
WAREHOUSE	2,203		
OFFICE	103		
MEZZANINE	134		
LOWER LEVEL (OFFICE & WAREHOUSE)	3,266		

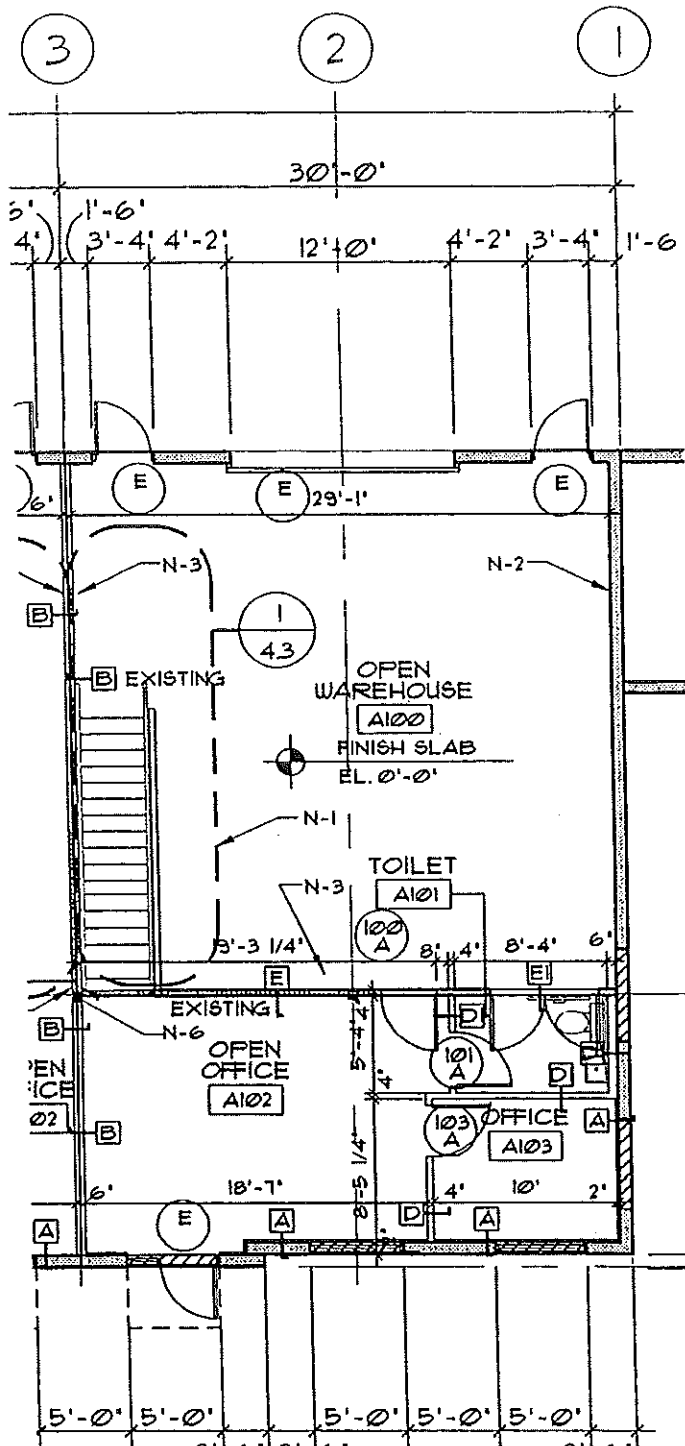

PLAN - LEVEL ONE

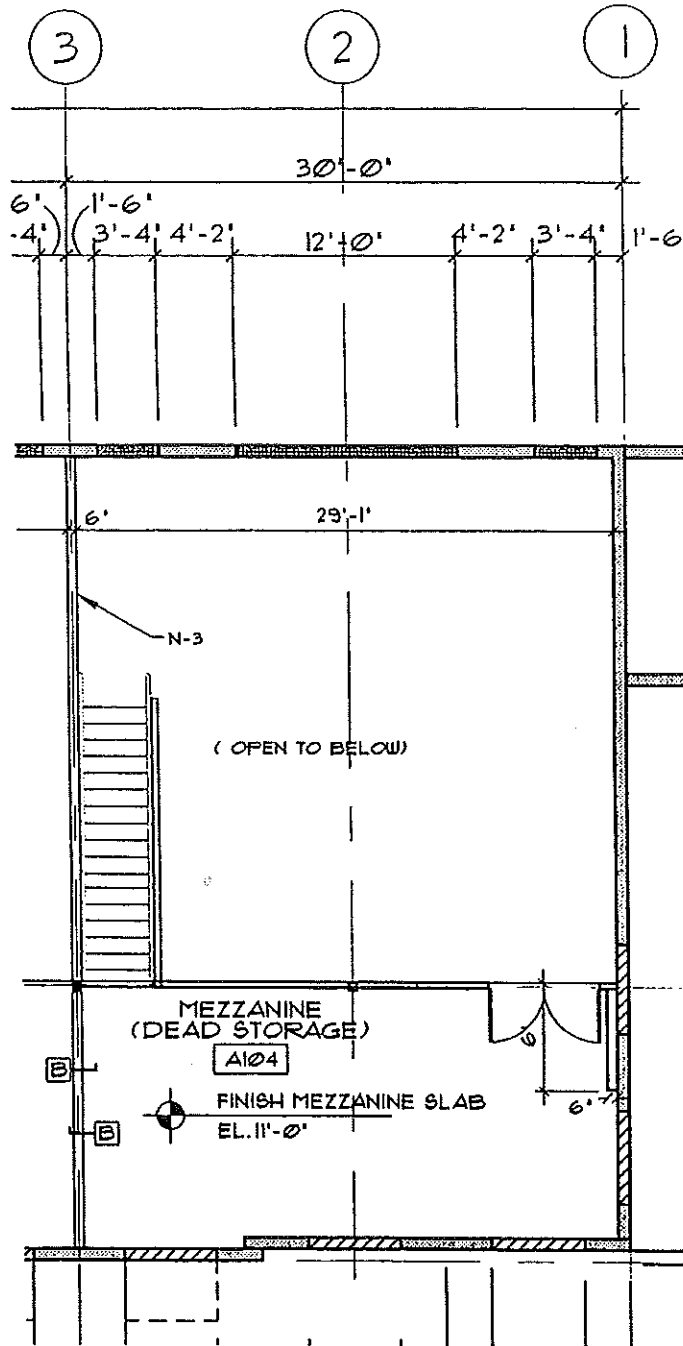

PLAN - LEVEL TWO

SQUARE FOOT CALCULATIONS - TYPE 8			
AREA	SQ. FT.	%	REMARKS
WAREHOUSE	600		
OFFICE	431		
MEZZANINE	444		
LOWER LEVEL (OFFICE & WAREHOUSE)	1031		
GROSS (OFFICE, WAREHOUSE, MEZZANINE)	1475		
% OF MEZZANINE TO LOWER LEVEL		33.2	
% OF OFFICE TO GROSS		29.2	OFFICE AREA LESS 55 SQ. FT. OF TOILET AREA

ALL CALCULATIONS ARE TAKEN FROM OUTSIDE OF THE BUILDING SHELL TO THE CENTER LINE OF THE DEMISING WALL

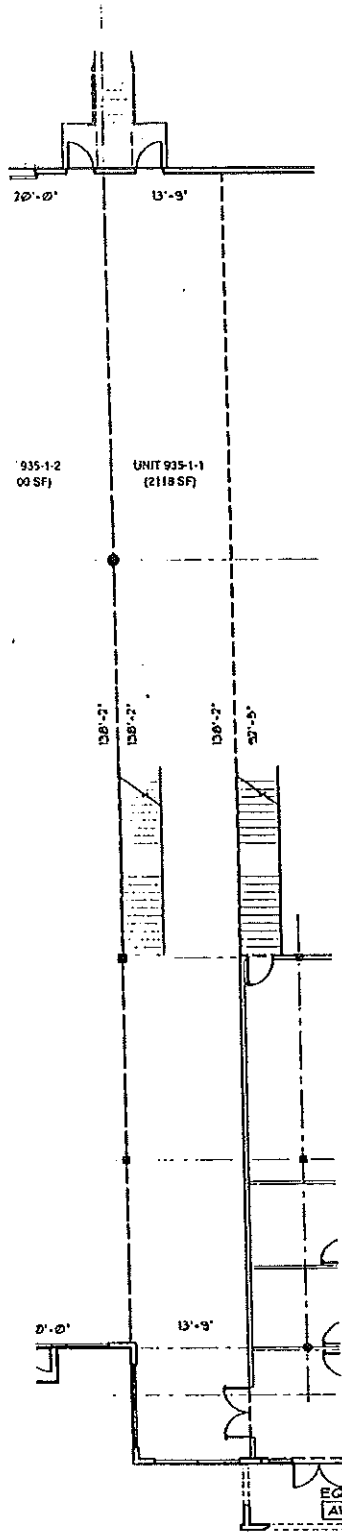

PLAN - LEVEL ONE

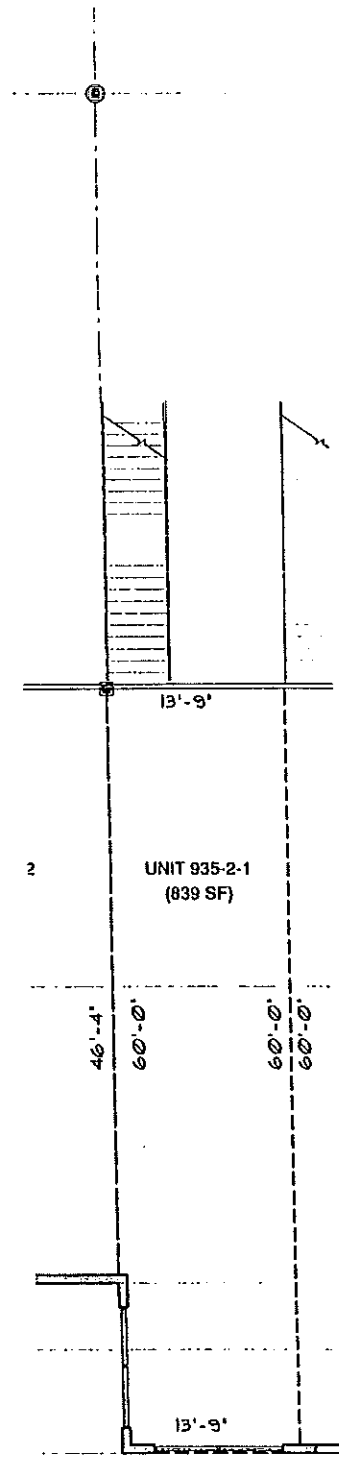

PLAN - LEVEL TWO



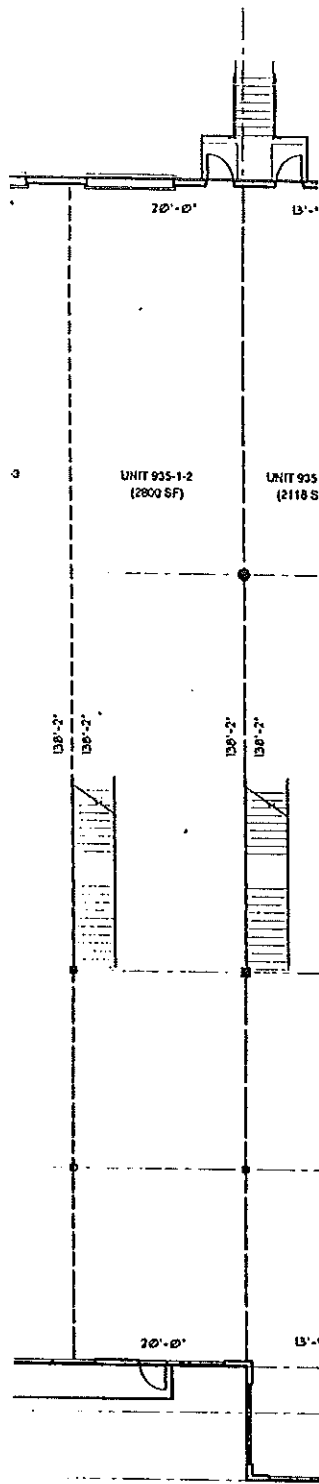

PLAN - LEVEL ONE

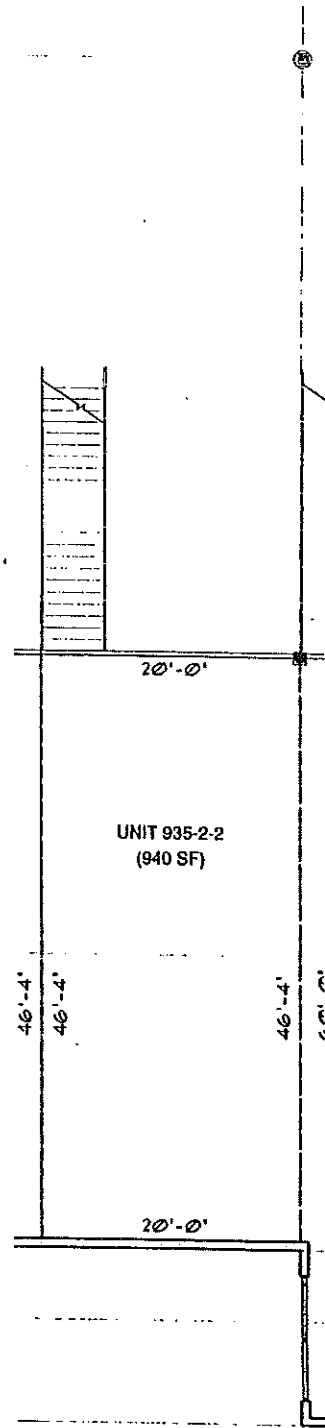

PLAN - LEVEL TWO

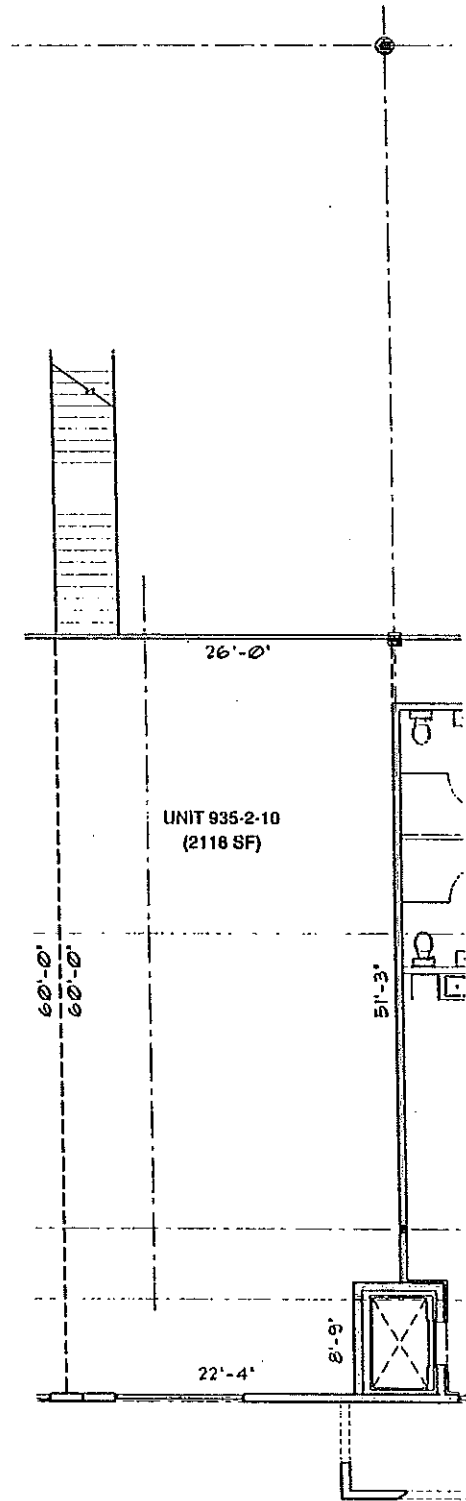

PLAN - LEVEL TWO