



HIGHPOINT BUSINESS CENTER

8131 IH-10 W | San Antonio, Texas 78230



RENOVATIONS
NOW
COMPLETED!



HIGHPOINT BUSINESS CENTER

8131 IH-10 W | San Antonio, Texas 78230

Updates Include:

- Fresh exterior of building
- Updated building signs
- Renovated street-facing pylon
- Renovated suites in all vacancies



Highpoint Business Center is a two-story, 45,000 SF multi-tenant office/retail center built in 1982 and renovations in 2022. Conveniently located off of IH-10 W frontage Rd, just west of Callaghan in Northwest San Antonio; Highpoint Business Center offers excellent visibility and exposure from every direction.

- Parking ratio - 5/1,000
- Monument signage available
- Move-in ready spec suites



SITE PLAN

Renovations Now Completed



Suite 259
6,980 RSF

[Click here to view Floor Plan](#)



Suite 130
1,470 RSF

[Click here to view Floor Plan](#)

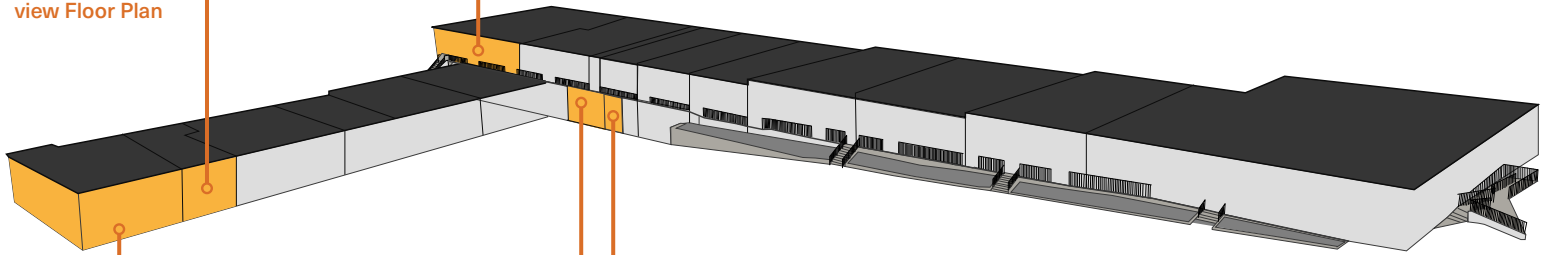

Suite 139
3,005 RSF



[Click here to view Floor Plan](#)

Suite 111
2,085 RSF



[Click here to view Floor Plan](#)

Suite 109
850 RSF



[Click here to view Floor Plan](#)

AERIAL LOCATION



FLOORPLANS

LEVEL 1

Suite 109
850 RSF
(Move-In Ready)

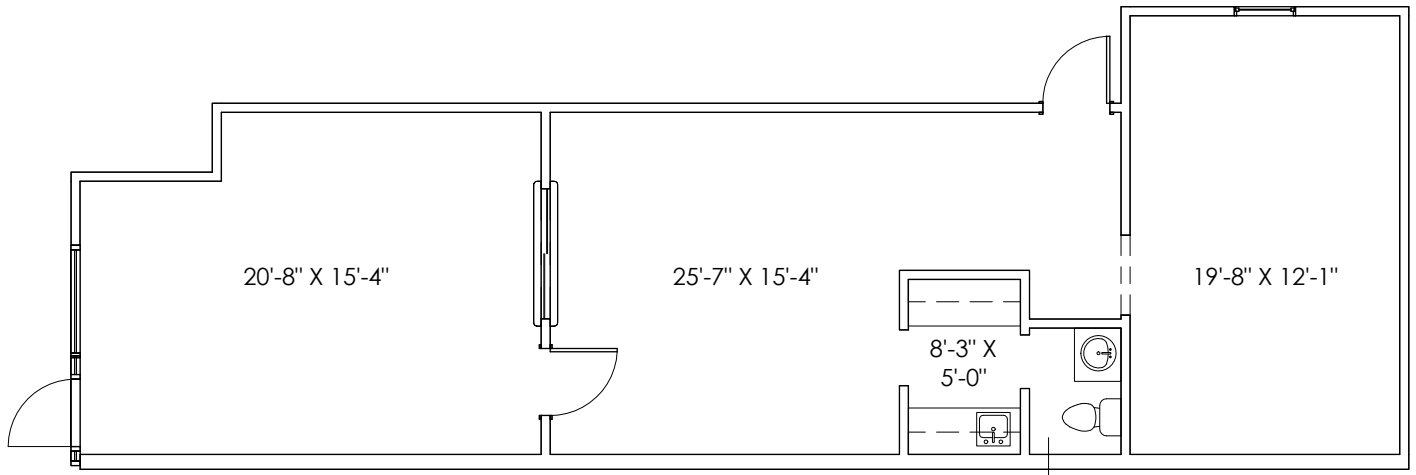

SITE PLAN

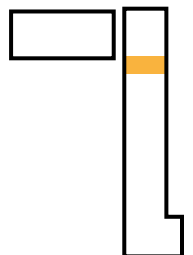

FLOORPLANS

LEVEL 1

Suite 111
2,085 RSF

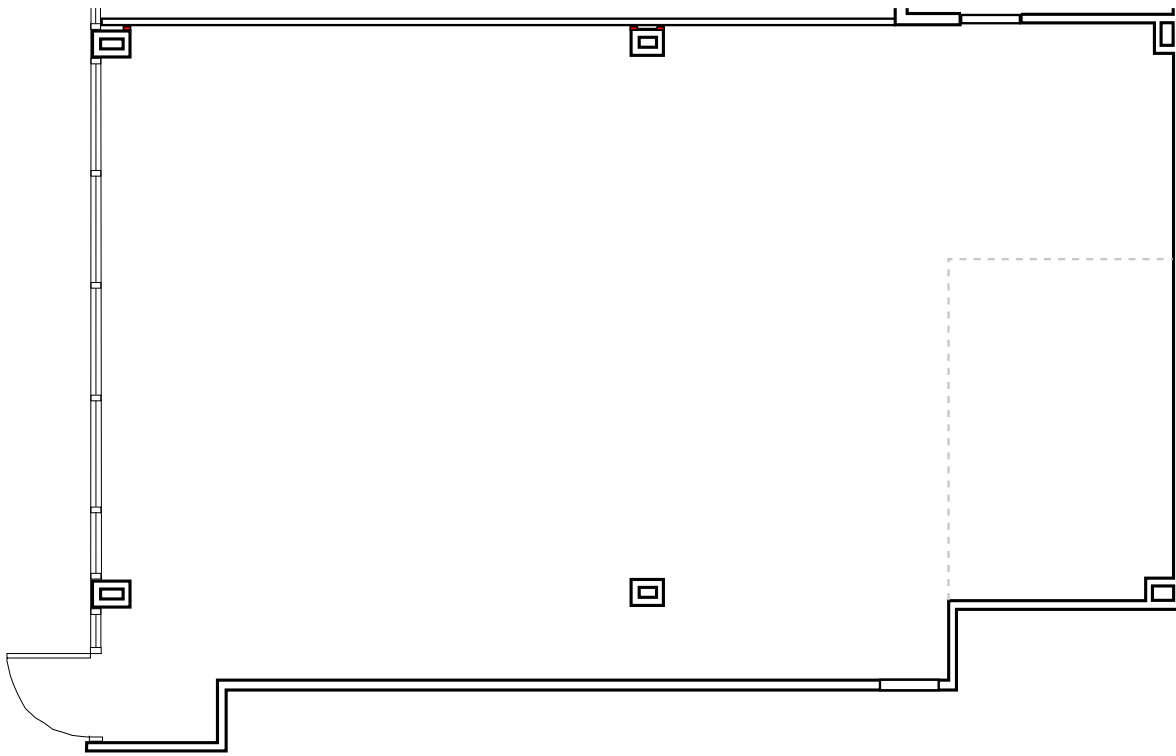

SITE PLAN

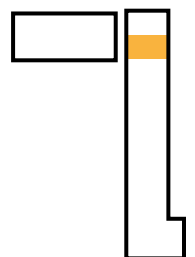

FLOORPLANS LEVEL 1

Suite 130 1,470 RSF

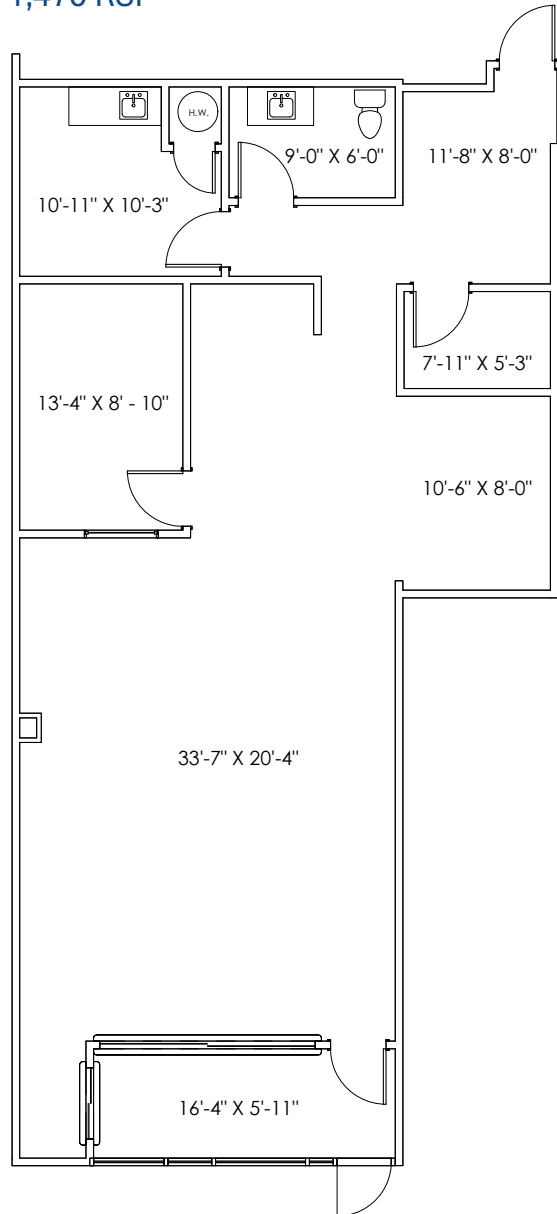

SITE PLAN

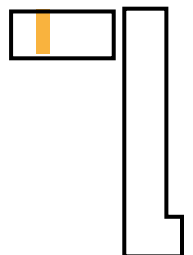

FLOORPLANS

LEVEL 1

Suite 139
3,005 RSF

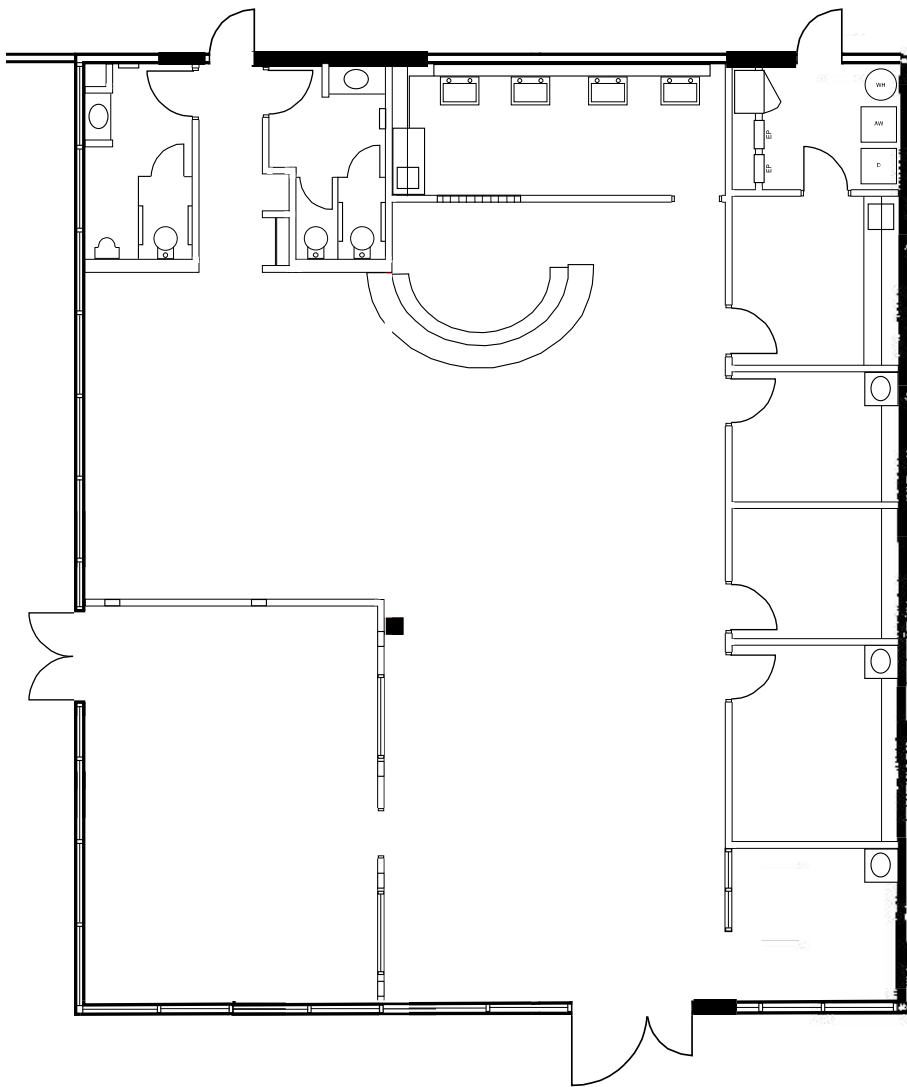

SITE PLAN

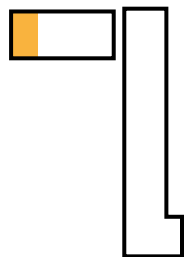

FLOORPLANS LEVEL 2

Suite 259
6,980 RSF

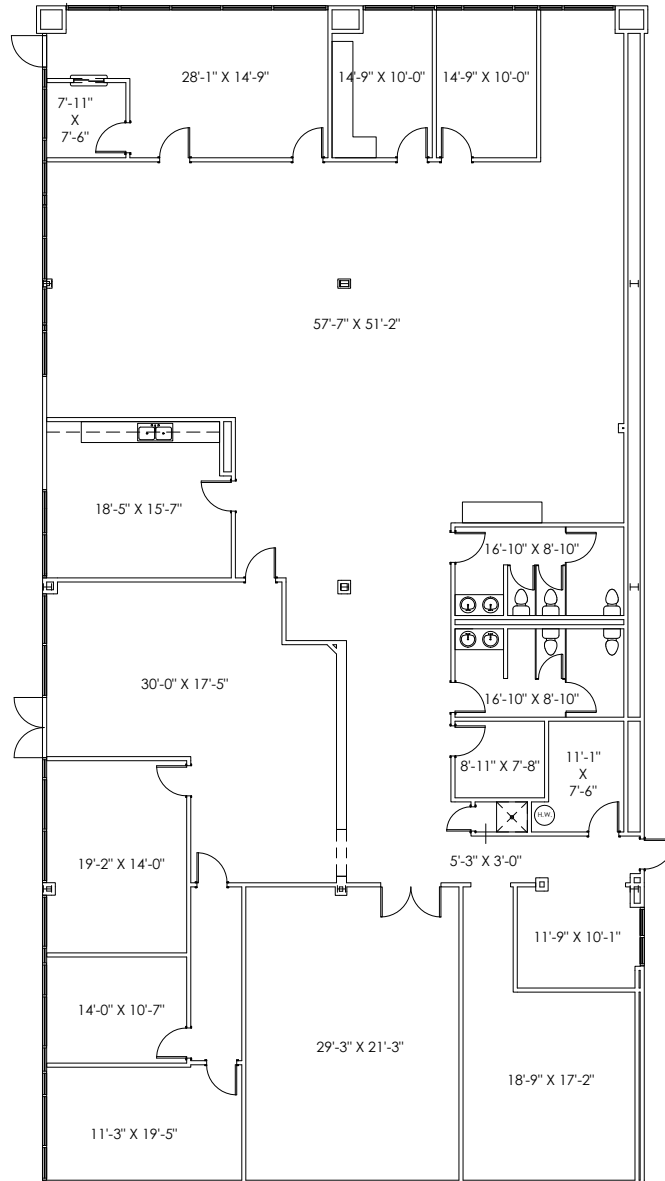

SITE PLAN

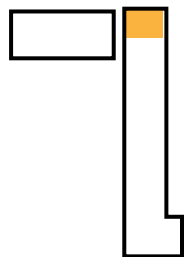

AMENITIES MAP

1 Mile-Radius



RESTAURANTS

- Highlander Bar and Grill
- Dairy Queen
- Pizza Patrón
- Oak Hills Tavern
- Original Blanco Café
- Papa John's Pizza
- Jersey Mike's Subs
- Beirut Mediterranean Restaurant
- Taqueria Datapoint
- Mama Adam Foods
- Sumo Japanese Steakhouse
- Mamacita's Restaurant
- Yaya's Treat
- Farm Fresh Produce Meat Deli
- Freshest Ice Creams
- Jimmy John's
- Las Palapas
- Subway
- Chacho's
- Starbucks
- Taqueria El Trompo
- Lennys Grill & Subs
- Big John's Pizza
- Ray's Pizzeria
- Noppagao Thai Cuisine
- Beijing Express
- Madurai Mes
- Mama Chita's
- Old Smokehouse
- Paul's Pizza Roma & Pub
- Sun Sun Chinese
- Sangria on the Burg
- Thai House 2 Restaurant
- Dimassi's Mediterranean Buffet
- Dave & Buster's

SHOPPING/RETAIL

- Jiffy Lube
- UPS Store
- Wash Em Car Wash 3
- Car Max
- APEX Smart Home
- Quick Lane Tire & Auto Center
- Red McCombs Ford
- Ford Parts
- Salon Mira Bella
- RDA Pro-Mart
- Asel Art Supply
- Dollar General
- Petco
- Sprouts Farmers Market
- Ritecare Pharmacy
- Sasha's European Market
- FedEx Office Ship Center
- Worldwide Express
- Lucia Bowen Co
- Lowe's Home Improvement
- Miss Chickpea's Bakeshop
- Academy Sports + Outdoors
- Discount Tire
- The Liquidation Guys
- Payless Used Office Furniture
- National Wholesale Supply, Inc.
- Dellview Park
- Bargain Price Movers
- Santikos Entertainment
- Target
- CVS
- Auto Showcase
- Elicia Threading and Beauty Salon
- D & B Liquor
- Don's & Ben's
- Great Clips
- Medical Uniforms
- Don Jonietz Pro Shop
- Minnanno Japanese Grocery
- Hazel Sky Smoke & Vape
- Denman Estate Park

BANKS

- Lone Star National Bank
- Plains Capital Bank
- Plains State Bank
- BBVA Bank
- BB&T

HOTELS

- LStudio 6
- Country Inn & Suites
- La Quinta Inn & Suites
- Embassy Suites
- Marriott

GAS STATIONS

- Shell
- Valero
- Exxon
- Chevron



CONTACT INFO:

Zander Thomas
210.298.8541
zander.thomas@streamrealty.com

Talaya Winton
210.298.8559
talaya.winton@streamrealty.com