

Electrical Information:

Breaker Panel: 1
Service Type: 120/208
Panel Type: NQ
Panel Number: Not Listed
Manufacturer: Square D
Amps: 225
Location: Storage Room

Breaker Panel: 2
Service Type: 120/208
Panel Type: NQOB
Panel Number: Not Listed
Manufacturer: Square D
Amps: Unreadable
Location: Storage Room

Exterior Disconnect Information:

Amps: 400
Panel Type: Safety Switch
Panel Number: Not Listed
Manufacturer: Square D
Location: Storage Room

Ceiling Information:

Height from Floor to Ceiling:
Front: 12' Back: 12'
Floor to Bottom of Deck:
Front: 20' Back: 19' 6"
Floor to Bottom of Joist:
Front: 18' Back: 17' 11"

Fire Information:

Riser Location: No Riser in Unit
Sprinkler Heads Present: Yes
Number of Sprinkler Heads: 33
Fire Alarm Control Panel Present: No
Brand: N/A
Model: N/A

Water Heater Information:

Gallons: 19.9
Water Line (in): 1"
Manufacturer: Rheem
Model: GE20P06SAG
Serial: GEQ431313666
Location: Storage Room

Backflow Information:

Number: 0
Size: N/A
Location: No Backflow Preventor Present

HVAC Information:

Unit: 1
Manufacturer: TRANE
Model: TSC120F3R0A1F000100
Serial: 174711208L
Tonnage: 10
Year: 2017

Unit: 2
Manufacturer: TRANE
Model: YSC120F3ELA0E00000
Serial: 154010323L
Tonnage: 10
Year: 2015

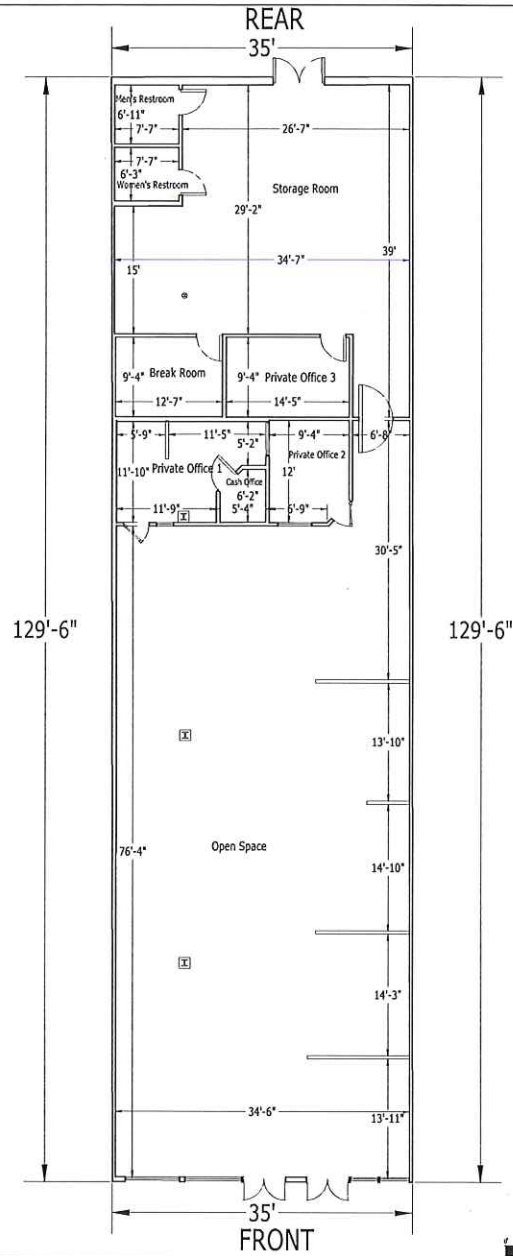

1 MAIN FLOOR

Virtual Tour Link

Bellevue Shopping Center

Unit # 58450
58450 Bellevue Drive
Bastrop, LA 70754



Regency Centers
One Independence Drive
Suite 111
Jacksonville, FL 32202

Unit # 58450
Ground Floor
4,536 SF

Construction and renovation work shall adhere to ICCA standards

Width
35'
Depth
129'-6"

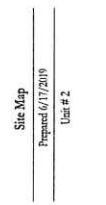

Site Map
Prepared: 6/17/2019
Unit # 2

Plans produced by:
ID Plans

1101 N. Tarry St. Suite 2070
Tampa, FL 33612
Phone: (813) 657-2545
www.idplans.com



© 2019
This plan is the property of ID Plans and is not to be reproduced, stored in a retrieval system, or transmitted in any form or by any means, electronic, mechanical, photocopying, recording, or by any information storage and retrieval system, without the prior written permission of ID Plans. ID Plans is not responsible for any errors or omissions in this plan. ID Plans is not responsible for any damage or injury resulting from the use of this plan. ID Plans is not responsible for any delay or interruption of service resulting from the use of this plan. ID Plans is not responsible for any loss of data or information resulting from the use of this plan. ID Plans is not responsible for any loss of revenue resulting from the use of this plan. ID Plans is not responsible for any loss of profit resulting from the use of this plan. ID Plans is not responsible for any loss of business resulting from the use of this plan. ID Plans is not responsible for any loss of reputation resulting from the use of this plan. ID Plans is not responsible for any loss of goodwill resulting from the use of this plan. ID Plans is not responsible for any loss of any other thing resulting from the use of this plan.



Space Profile for

Unit: # 58450
Area: 4,536 sq ft

Address

58450 Belleview Drive
Plaquemine, LA 70764

ID PLANS

400 N. Tampa St. Suite 2210
Tampa, FL 33602

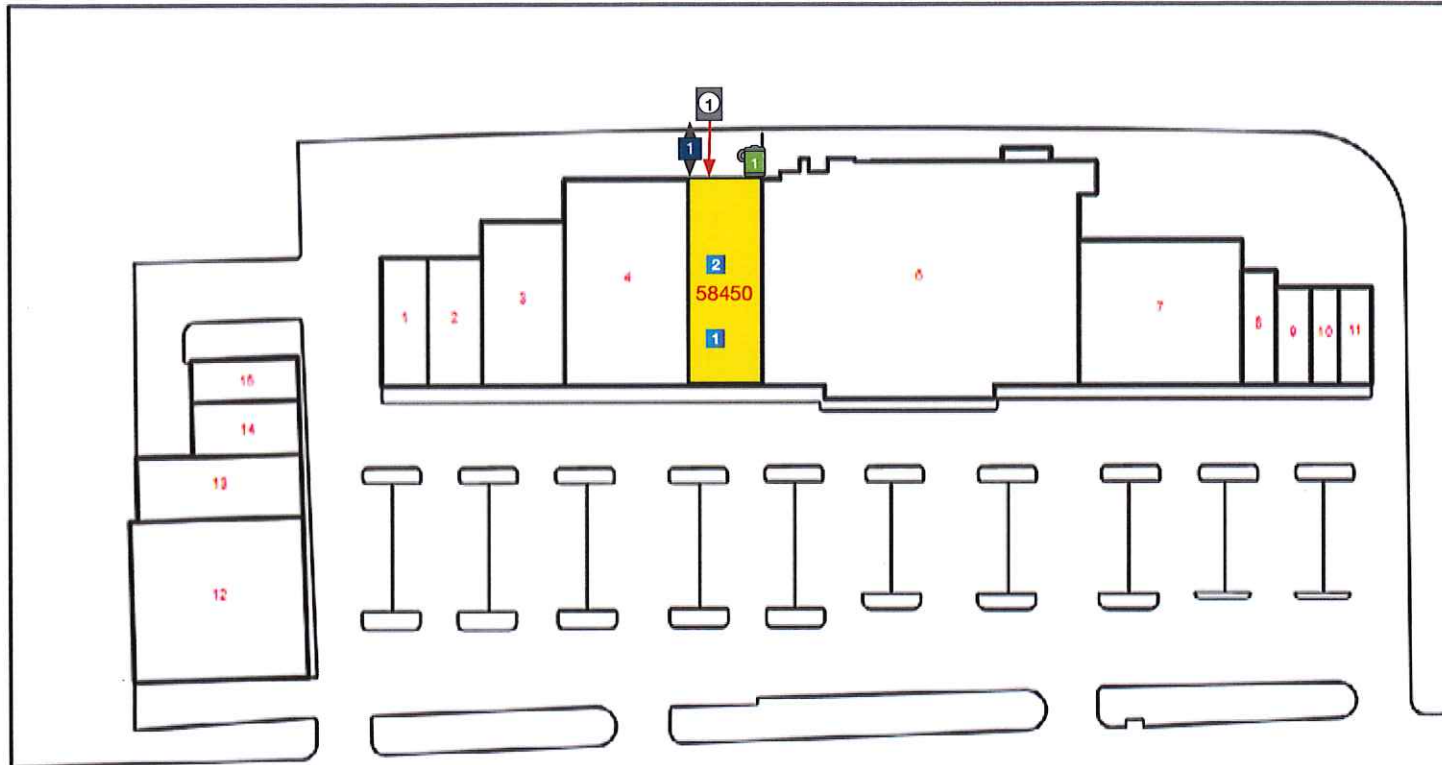

Prepared
6/24/2019

Address
58450 Bellevue Drive
Plaquemine, LA 70764



















































Please See Meter & HVAC Information on the Next Page

Meter & HVAC Information

Meter Information	Reference	Meter
	Electric	136820322
	Gas	492
	Water	33575722

HVAC Units & Information	Unit	Space	Manufacturer	Model	Ton	Serial	Year
	1	58450	TRANE	TSC120F3R0A1F000100	10	174711208L	2017
	2	58450	TRANE	YSC120F3ELA0E000000	10	154010323L	2015

Legend

	Breaker Panel		Fire Extinguisher		Ceiling Fan w/ Light		Fire Sprinkler
	Circular Column		Fire Alarm Pulldown		Rectangular Column		Pocket Door
	Appliance Outlet		Glass Door		Refrigerator		Track Lighting
	Fire Alarm		Handicap Handrail		Roll-Up Door		2-Bulb Fluorescent Lighting
	Drinking Fountain		Roof Hatch		Sink		3-Bulb Fluorescent Lighting
	Door		HVAC Unit		Swing Door		4-Bulb Fluorescent Lighting
	Double Hung Door		Recessed Light		Toilet		Ceiling Air Vent
	Electrical Outlet		Staircase		Can Light		Air Diffuser
	Emergency Light		Water Heater		Urinal		Ceiling Fan w/o Light
	Exit Light		Telephone Panel		Thermostat		Air Handler
	Tankless Water Heater		Window Wall Opening		RJ 45		Fire Alarm Control Panel
	Step Down Transformer		Maintenance Sink		Window		
	Disconnect						

Disclaimer: All items may not show on feature pages.

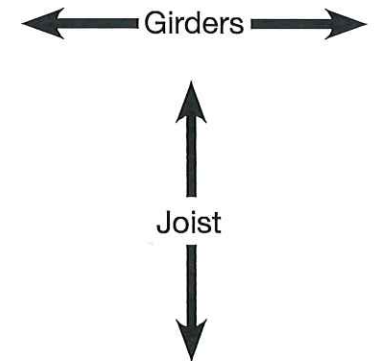
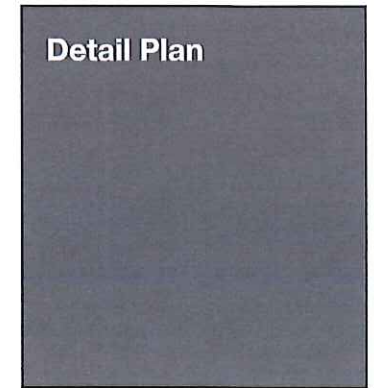
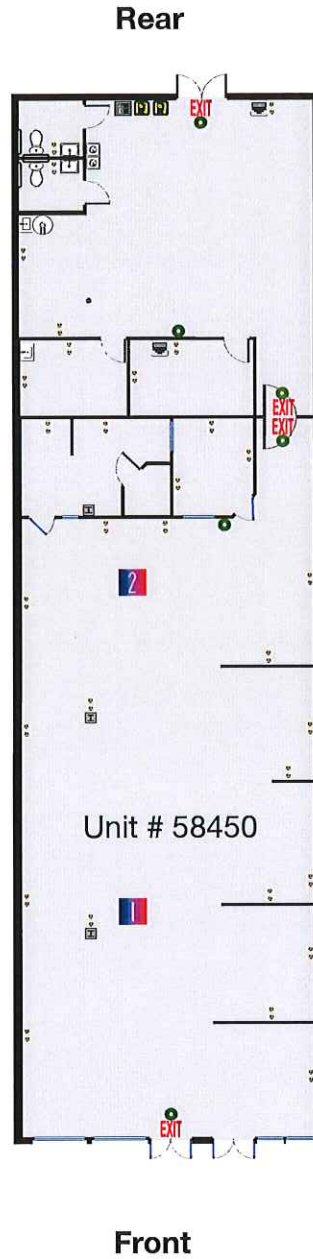

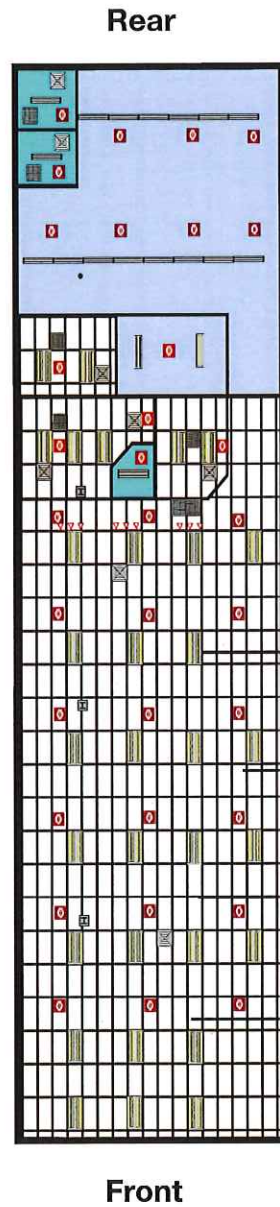

Acoustic Ceiling

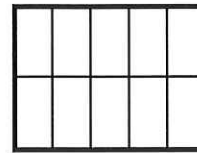

Open Ceiling



Drywall Ceiling



← Girders →

↑ Joist ↓

Reflected Ceiling Plan

Ceiling Specifications

Height from Floor to Ceiling

Front: 12'

Back: 12'

Floor to Bottom of Deck:





Front: 20'

Back: 19' 6"

Floor to Bottom of Joist

Front: 18'

Back: 17' 11"

	Type	Fixture	Qty
Lighting		2 Bulb Fluorescent Encased	19
		4 Bulb Fluorescent Encased	32
		Track Lighting	3
Fire Info	Sprinkler Heads	Present	Qty
		Yes	33