

# 210 CORPORATE PARK

1285 COUNTY ROAD 210 W

St. Johns, FL 32259

PUD Zoning

8,000+/- Sq Ft Building

ASKING PRICE  
**\$2,200,000**

1.62+/- Acres  
27,500 AADT

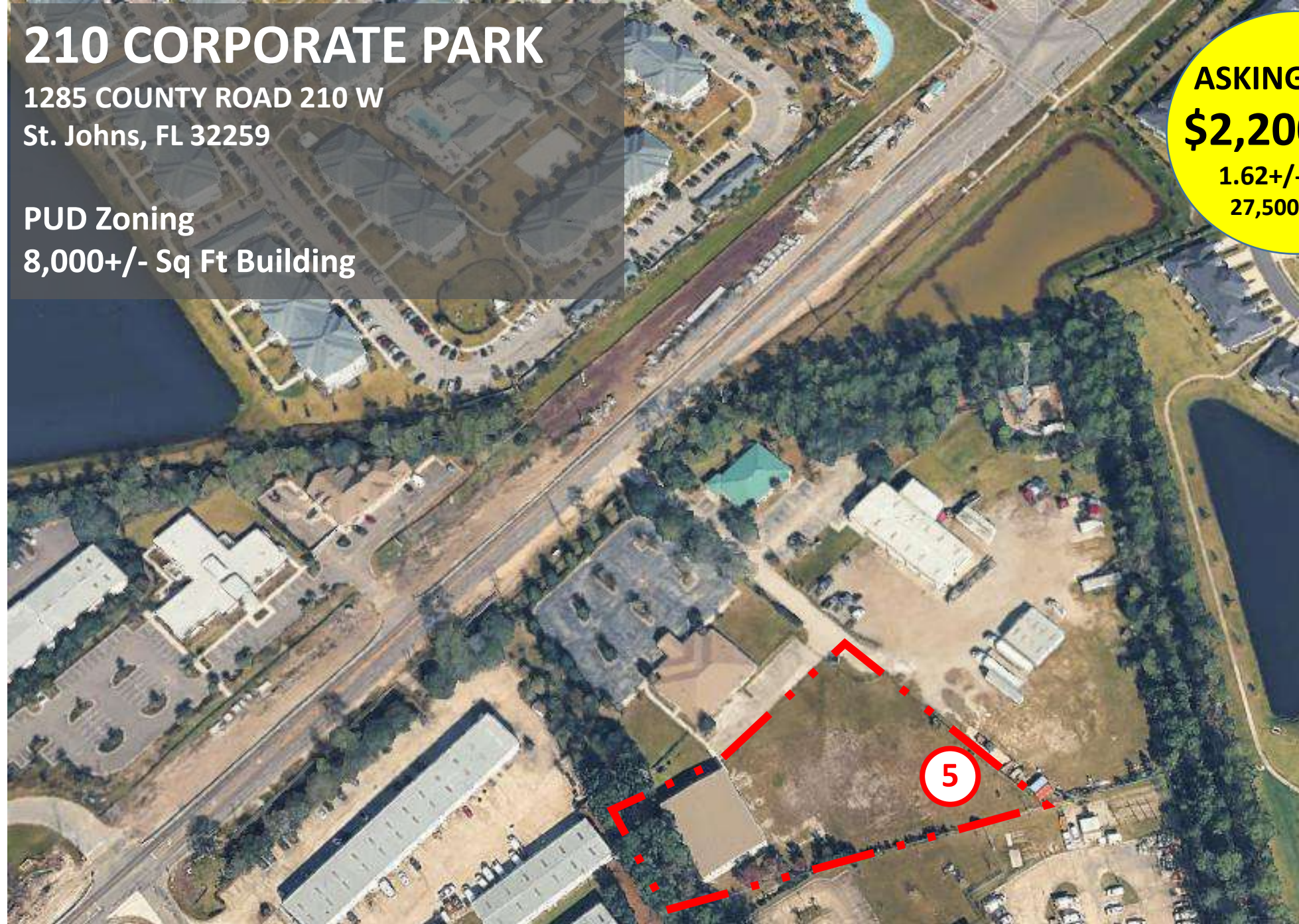

## Michael Woods

Licensed Real Estate Broker

Direct: (980) 262-4200

Cell: (302) 559-0012

michael@cbbcre.com

FL: BK3588582

## Alexandra Papageorge

Licensed Real Estate Broker

Direct: (980) 262-4200

Cell: (704) 804-1597

alexandra@clearcreekbrothers.com

FL: SL3623743

**CLEARCREEK**  
BROTHERS MANAGEMENT, LLC

Boundary line is approximate – refer to survey.





Personal Items Will Be Removed

5

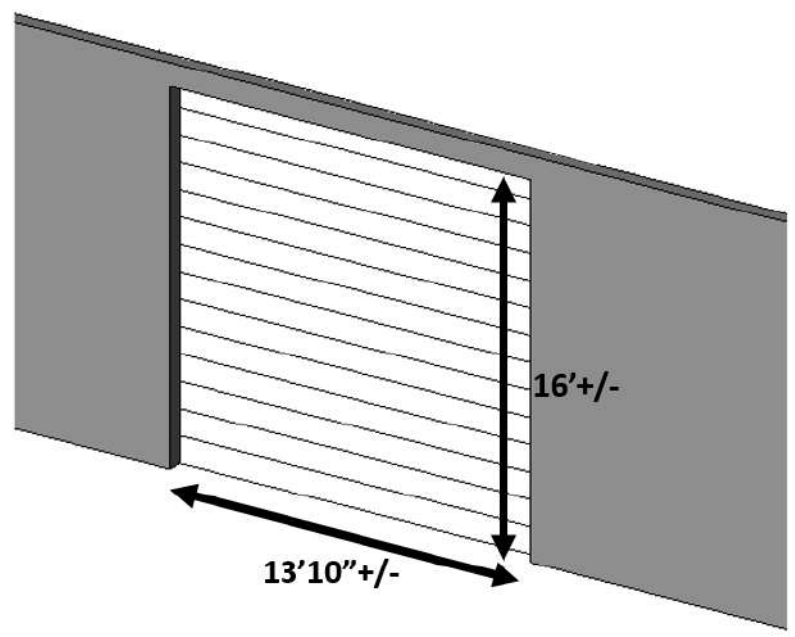
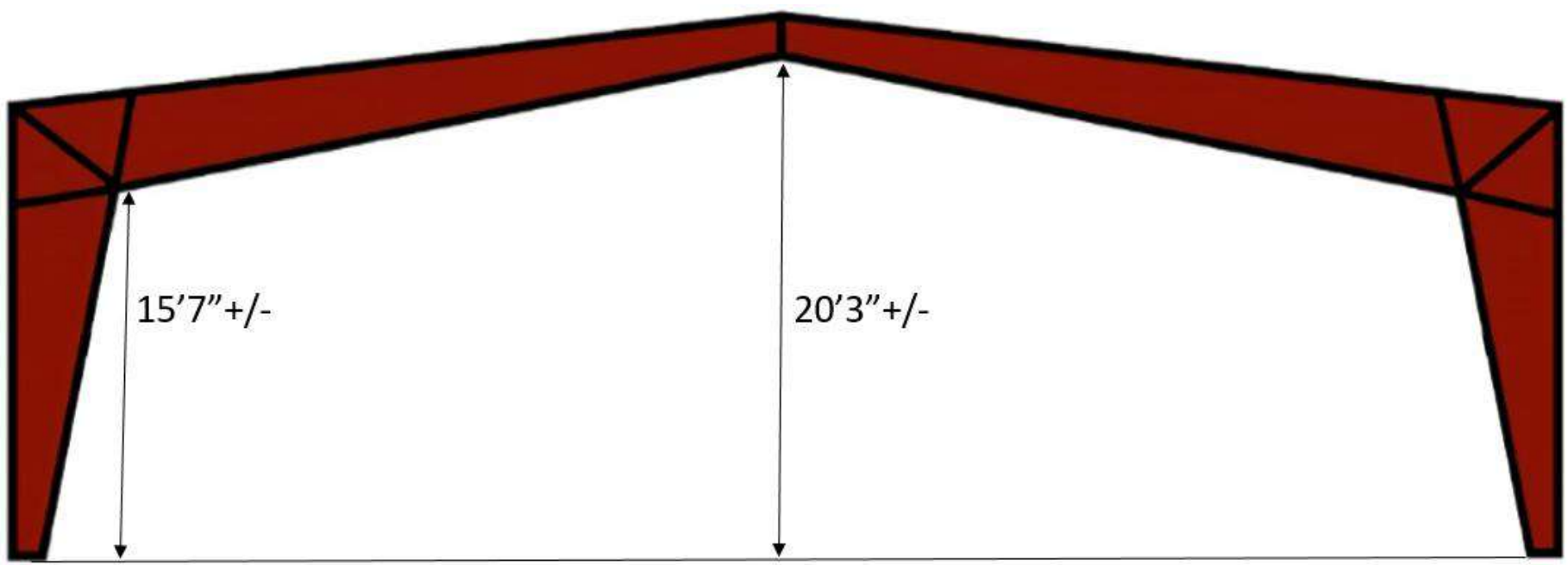

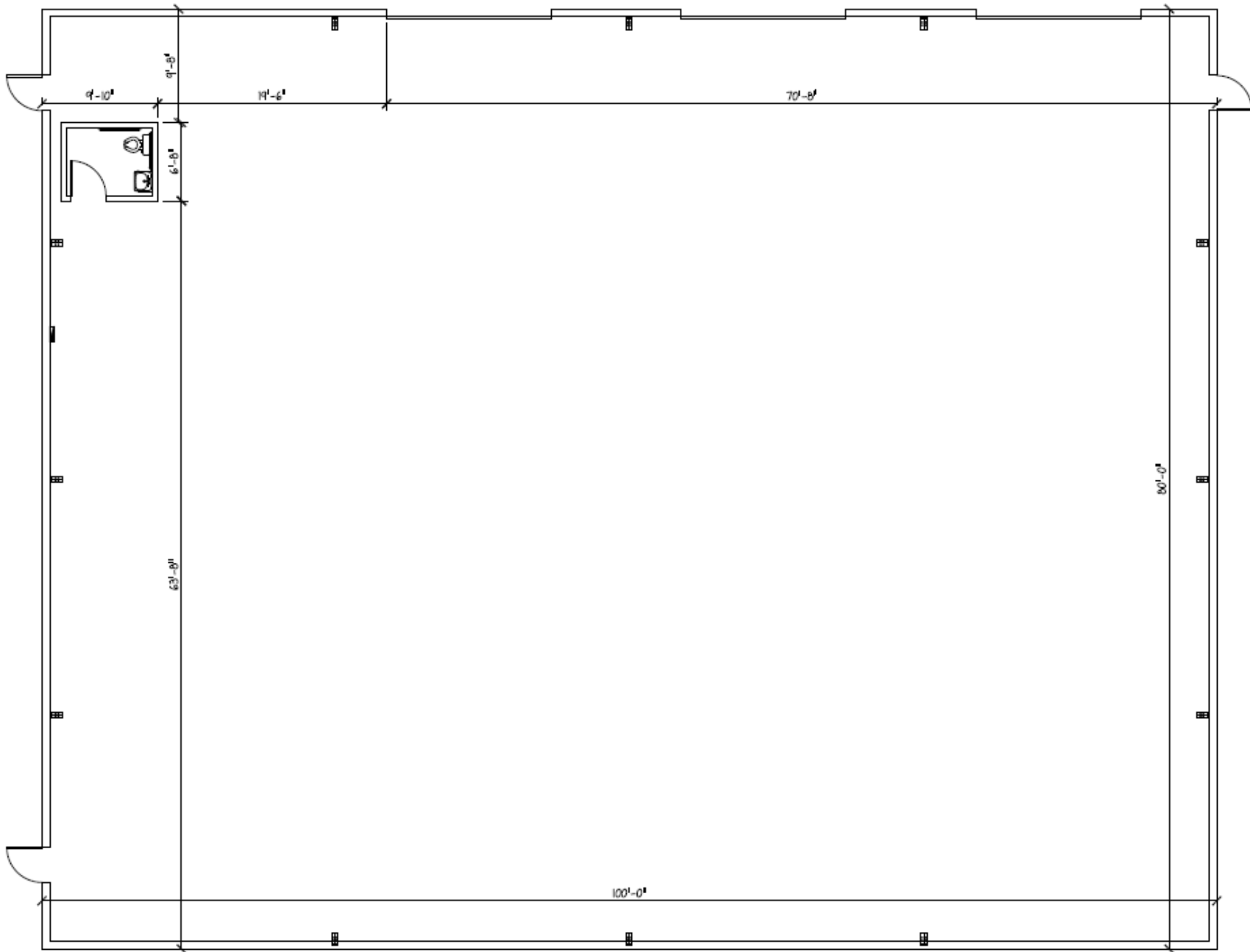

1279 COUNTY RD. 210  
WAREHOUSE  
FLOOR 01  
0' 3' 6' 10'



**CLEARCREEK**  
BROTHERS MANAGEMENT, LLC

**1279 CR-210 W, St. Johns County, Florida**

Nestled in the vibrant heart of St. Johns County, Florida, the area around 1279 CR-210 W embodies a harmonious blend of suburban serenity and modern convenience.

This rapidly growing region features master-planned communities like St. Johns Forest and SilverLeaf, offering gated residences, neighborhood parks, extensive sidewalks, and award-winning amenities including pools, fitness centers, and recreational trails.

Residents benefit from top-rated A-rated schools, easy access to major roads such as I-95, and proximity to shopping centers, dining options, and golf courses. Just a short drive away lie the pristine beaches of St. Augustine and the bustling metro area of Jacksonville, providing endless opportunities for cultural activities, historic exploration, and coastal leisure. With its stunning natural scenery, safe and welcoming neighborhoods, and exceptional quality of life, this locale is an ideal haven for families, professionals, and those seeking a balanced Florida lifestyle.

This information has been secured from sources we believe to be reliable, but we make no representations or warranties, expressed or implied, as to the accuracy of the information. References to square footage or age are approximate. Buyer must verify the information and bears all risk for any inaccuracies. Any projections, opinions, assumptions or estimates used herein are for example purposes only and do not represent the current or future performance of the property. GROK sources document available upon request. Boundary line is approximate – refer to survey.

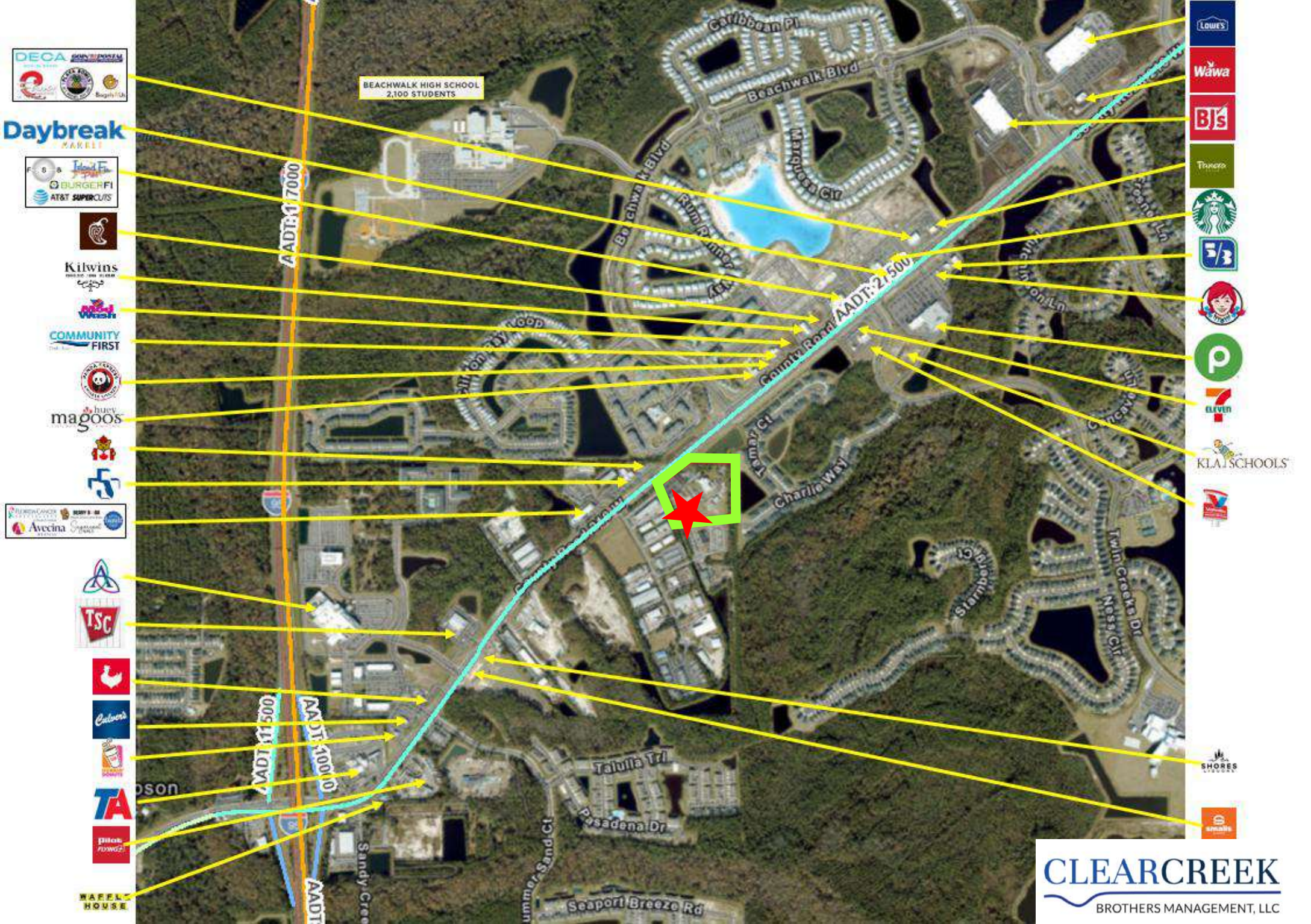

This information has been secured from sources we believe to be reliable, but we make no representations or warranties, expressed or implied, as to the accuracy of the information. References to square footage or age are approximate. Buyer must verify the information and bears all risk for any inaccuracies. Any projections, opinions, assumptions or estimates used herein are for example purposes only and do not represent the current or future performance of the property. GROK sources document available upon request.

## ABOUT THE PROPERTY

5

<b>ADDRESSES:</b>	1285 County Road 210 W, St. Johns, FL 32259
<b>EXISTING BUILDING SIZES:</b>	8,000+/-
<b>BUILDINGS BUILT:</b>	2007
<b>TOTAL LAND AREA:</b>	1.62+/- Acres
<b>PARCEL NUMBERS:</b>	To Be Determined
<b>2024 FL DOT TRAFFIC COUNTS:</b>	27,500 AADT
<b>ZONING:</b>	PUD Planned Development – City of St Johns
<b>FRONTAGE:</b>	No Frontage
<b>EXPENSES:</b>	DURING DUE DILIGENCE
<b>STATED INCOME:</b>	DURING DUE DILIGENCE

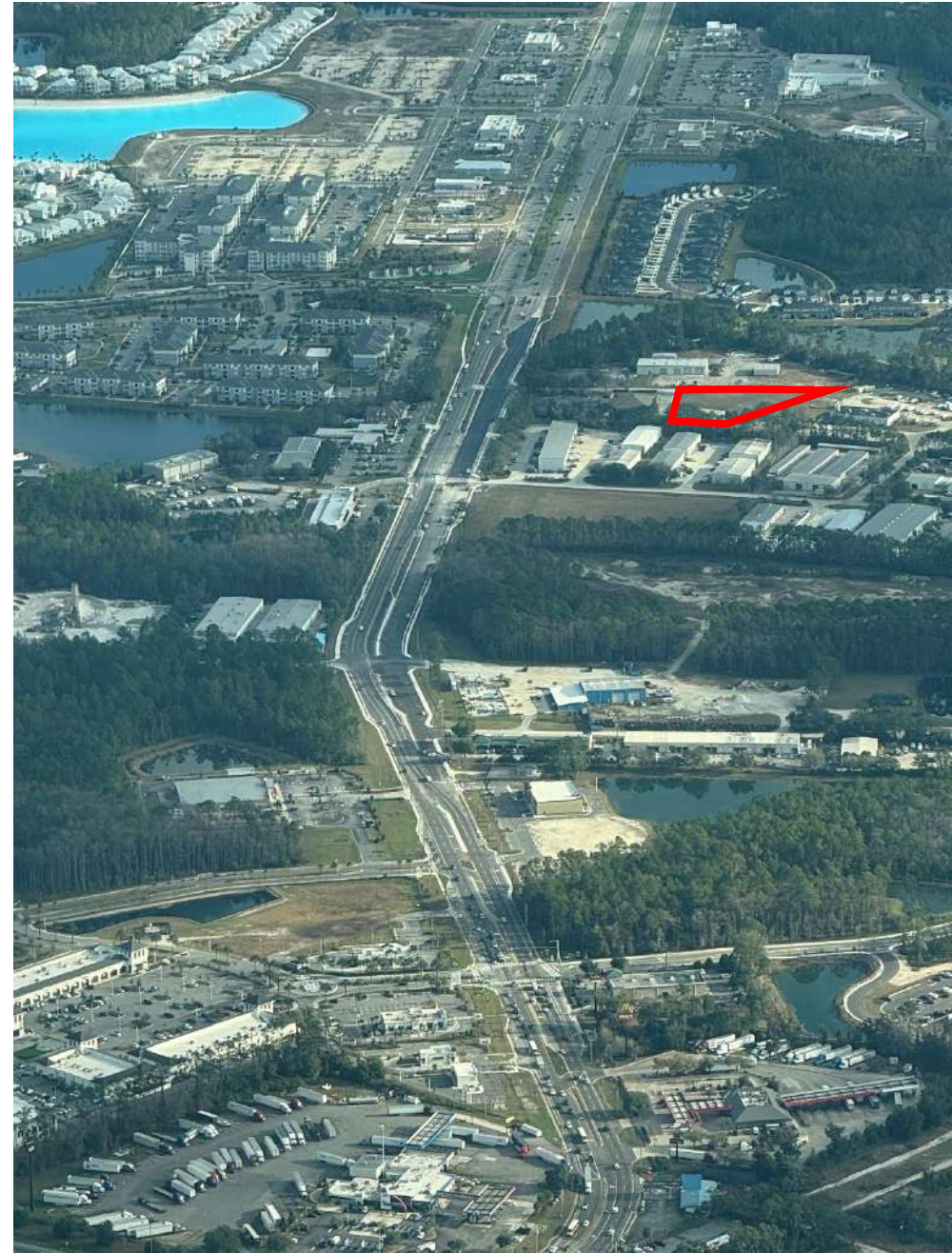

**CLEARCREEK**  
BROTHERS MANAGEMENT, LLC

# SITE PLAN

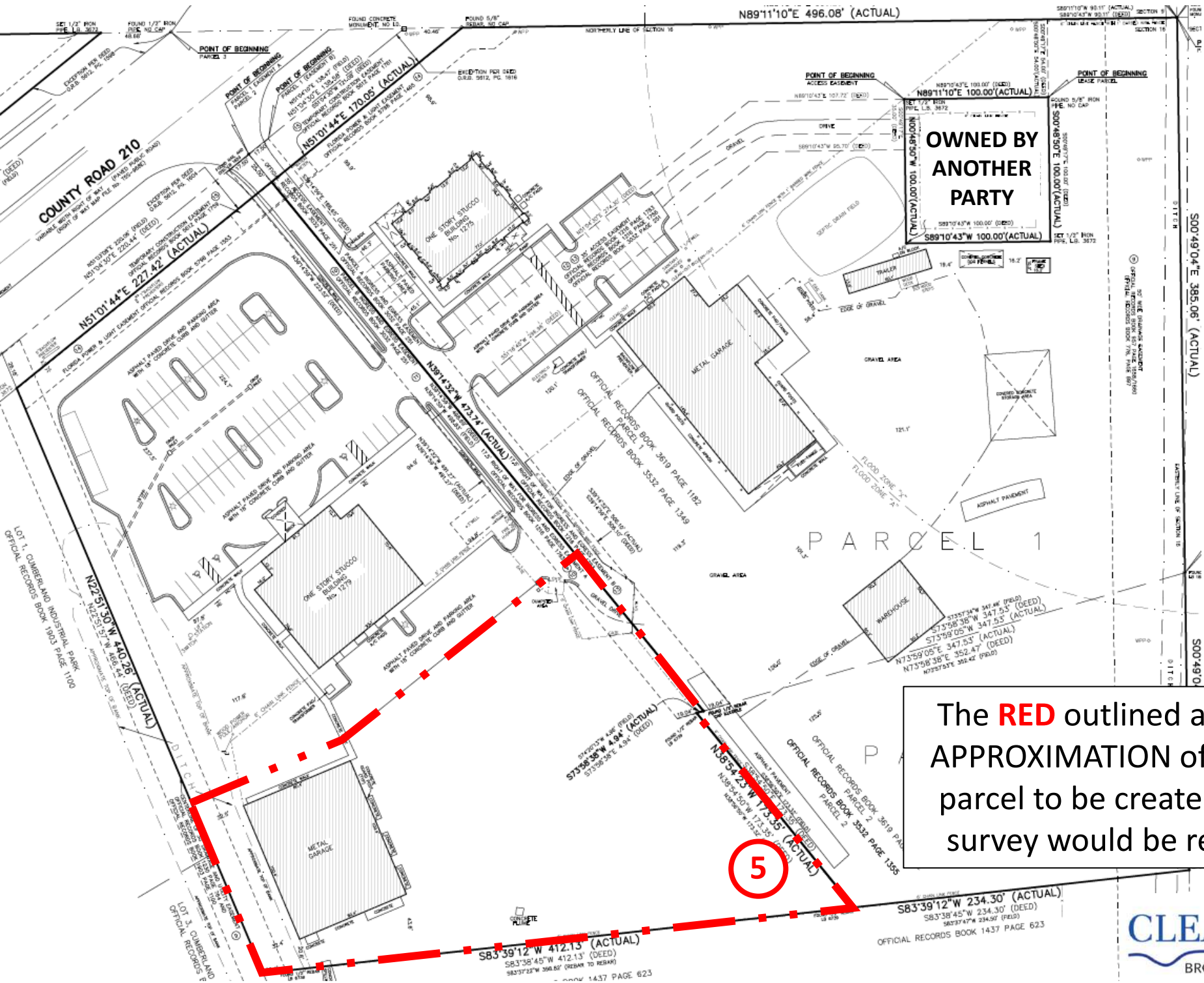

The **RED** outlined area is an APPROXIMATION of the new parcel to be created; a new survey would be required.



# DEMOGRAPHICS



## Executive Summary

1279 County Road 210 W,  
Saint Johns, Florida, 32259

Rings: 1, 3, 5 mile radii

Latitude: 30.07396

Longitude: -81.48542

Population	1 MILE	3 MILES	5 MILES
2010 Population	115	11,577	28,779
2020 Population	931	20,938	66,146
2025 Population	4,668	28,123	94,726
2030 Population	5,627	32,620	112,160
2010-2020 Annual Rate	23.26%	6.10%	8.68%
2020-2025 Annual Rate	35.95%	5.78%	7.08%
2025-2030 Annual Rate	3.81%	3.01%	3.44%

2020 Male Population	48.4%	48.9%	48.4%
2020 Female Population	51.6%	51.1%	51.6%
2020 Median Age	35.8	36.1	37.2

2025 Male Population	49.6%	49.5%	49.1%
2025 Female Population	50.4%	50.5%	50.9%
2025 Median Age	35.5	36.1	38.4

Race and Ethnicity	1 MILE	3 MILES	5 MILES
2025 White Alone	65.2%	67.8%	68.1%
2025 Black Alone	7.3%	6.8%	6.9%
2025 American Indian/Alaska Native Alone	0.6%	0.4%	0.3%
2025 Asian Alone	11.1%	10.2%	10.2%
2025 Pacific Islander Alone	0.0%	0.1%	0.1%
2025 Other Race	2.3%	2.4%	2.6%
2025 Two or More Races	13.4%	12.4%	11.9%
2025 Hispanic Origin (Any Race)	13.2%	12.4%	11.7%

Households	1 MILE	3 MILES	5 MILES
2025 Wealth Index	162	166	160
2010 Households	39	3,747	9,966
2020 Households	301	6,724	23,054
2025 Households	1,715	9,657	33,010
2030 Households	2,059	11,180	38,798
2010-2020 Annual Rate	22.67%	6.02%	8.75%
2020-2025 Annual Rate	39.30%	7.14%	7.08%
2025-2030 Annual Rate	3.72%	2.97%	3.28%
2025 Average Household Size	2.72	2.91	2.86

Median Household Income	1 MILE	3 MILES	5 MILES
2025 Median Household Income	\$134,583	\$145,057	\$133,546
2030 Median Household Income	\$160,942	\$165,764	\$152,905
2025-2030 Annual Rate	3.64%	2.70%	2.74%

Average Household Income	1 MILE	3 MILES	5 MILES
2025 Average Household Income	\$198,968	\$194,618	\$176,056
2030 Average Household Income	\$230,905	\$219,659	\$195,782
2025-2030 Annual Rate	3.02%	2.45%	2.15%

Per Capita Income	1 MILE	3 MILES	5 MILES
2025 Per Capita Income	\$71,229	\$64,383	\$62,815
2030 Per Capita Income	\$82,330	\$72,260	\$69,377
2025-2030 Annual Rate	2.94%	2.34%	2.01%

Housing	1 MILE	3 MILES	5 MILES
2025 Housing Affordability Index	92	102	93
2010 Total Housing Units	53	4,072	10,796
2010 Owner Occupied Housing	30	3,236	7,997
2010 Renter Occupied Housing	9	511	1,969
2010 Vacant Housing Units	14	325	830

2020 Total Housing Units	439	7,408	24,423
2020 Owner Occupied Housing	239	5,400	17,644
2020 Renter Occupied Housing	62	1,324	5,410
2020 Vacant Housing Units	115	744	1,614

2025 Total Housing Units	2,223	11,195	36,283
2025 Owner Occupied Housing	1,282	7,712	25,519
2025 Renter Occupied Housing	433	1,945	7,491
2025 Vacant Housing Units	508	1,538	3,273

2030 Total Housing Units	2,500	12,659	41,866
2030 Owner Occupied Housing	1,410	8,697	29,629
2030 Renter Occupied Housing	650	2,482	9,169
2030 Vacant Housing Units	441	1,479	3,068

In the identified area, the current year population is 94,726. In 2020, the Census count in the area was 66,146. The rate of change since 2020 was 7.08% annually. The five-year projection for the population in the area is 112,160 representing a change of 3.44% annually from 2025 to 2030. Currently, the population is 49.1% male and 50.9% female.

The median age in this area is 38.4, compared to U.S. median age of 39.6.

Current median household income is \$133,546 in the area, compared to \$81,624 for all U.S. households. Median household income is projected to be \$152,905 in five years, compared to \$92,476 all U.S. households.

Current average household income is \$176,056 in this area, compared to \$116,179 for all U.S. households. Average household income is projected to be \$195,782 in five years, compared to \$128,612 for all U.S. households.

Current per capita income is \$62,815 in the area, compared to the U.S. per capita income of \$45,360. The per capita income is projected to be \$69,377 in five years, compared to \$50,744 for all U.S. households.

This information has been secured from sources we believe to be reliable, but we make no representations or warranties, expressed or implied, as to the accuracy of the information. References to square footage or age are approximate. Buyer must verify the information and bears all risk for any inaccuracies. Any projections, opinions, assumptions or estimates used herein are for example purposes only and do not represent the current or future performance of the property. GROK sources document available upon request.

## County Road 210, St. Johns, FL

County Road 210 (CR 210) stands as a high-traffic, high-potential commercial corridor in rapidly expanding western St. Johns County, serving as a vital east-west connector between **I-95**, **US 1**, and key master-planned communities. This prime artery directly benefits from proximity to **St. Augustine** (tourism & historic draw), **Jacksonville** (business & logistics hub), **Ponte Vedra Beach** (luxury & golf prestige) and **Nocatee** (one of the fastest growing communities in the nation 2020)

### Major Infrastructure Upgrades Driving Value

- **CR 210 Widening Project** (Greenbriar Rd. to Cimarrone Blvd.): Major reconstruction to 4-lane urban divided arterial with median, bike lanes, and sidewalks. Paving underway; full completion targeted for **Summer 2026** — easing congestion and unlocking higher-density development.
- Additional improvements from I-95 to US 1, including added lanes, sidewalks, and interchange enhancements at US 1/CR 210 to eliminate at-grade intersections.
- Synergistic projects like CR 2209 upgrades (SR 9B to CR 210) further enhance regional connectivity.

### Booming Commercial & Mixed-Use Momentum

- **Beachwalk** community: Millions of square feet entitled for retail, office, and mixed-use in a beachfront lagoon setting; ongoing retail openings and hospitality projects (e.g., Compass Hotel by Margaritaville advancing in 2025).
- **210 East Development**: Recent sales and top-tier visibility along CR 210 for commercial pads.
- New retail/office space permitted (19,000+ SF alongside self-storage), plus fresh developments like leased retail at The Fountains at St. Johns.
- Entitled sites near I-95 ramps (e.g., 243± acres at CR 210/Moon Bay Pkwy) offer exceptional accessibility and visibility.
- Residential catalysts fueling demand: Approved 300-unit townhomes near CR 210/Sandy Creek; Tidal 210 townhome project advancing; proximity to top-selling communities like **SilverLeaf** (west of I-95 on CR 210 corridor), **Beacon Lake**, and others.

**Strategic Advantages for Investors** CR 210's corridor delivers strong demographics, limited prime competition, rapid absorption in retail/hospitality/office, and long-term appreciation driven by population surge, infrastructure billions, and master-planned expansions.

**Position your commercial portfolio along St. Johns County's most dynamic corridor—CR 210 offers unmatched access, v**  
Contact for current listings, entitled sites, and development opportunities.



# Strategic Advantages for Investors



1. **Explosive Affluent growth corridor** — One of Northeast Florida's fastest-growing areas, driven by massive master-planned communities (e.g., Shearwater, RiverTown, Beachwalk, Ashford Mills, SilverLeaf) bringing affluent residents and high household incomes (often >\$175K within miles).



2. **Prime accessibility & visibility** — Direct proximity to I-95 interchanges (often 1 mile or less), high average daily traffic (25,000+ vehicles in segments), and strong exposure for retail, restaurants, hotels, offices, medical, and service uses.



3. **Ongoing & planned momentum** — Active developments (e.g., 210 East, The Fountains at St. Johns, potential grocery anchors like Harris Teeter-sized stores, Margaritaville hotel, self-storage/office/retail pads) signal investor confidence, rising values, and demand in an underserved high-growth zone.

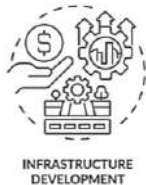

INFRASTRUCTURE  
DEVELOPMENT

4. **Supportive infrastructure & zoning** — Many parcels are entitled/ready for intensive commercial/mixed-use (retail, office, light industrial); county investments in road widening, infrastructure (\$800M+ capital projects), and business-friendly policies support long-term viability.



5. **Economic tailwinds** — St. Johns County's top-ranked growth, proximity to Jacksonville markets, affluent demographics, and incentives drive strong rental demand, appreciation, and income potential for commercial properties.

In short, CR-210 offers high-traffic, high-growth positioning in Florida's booming northern St. Johns suburbs—ideal for capital appreciation and steady returns in retail/service/hospitality sectors. Site-specific details vary (e.g., east vs. west of I-95), so verify with local brokers or county resources.

## Prime Commercial Real Estate in St. Johns County, Florida

Capitalize on one of Florida's hottest commercial markets—where explosive growth meets strategic location.

St. Johns County recorded nearly **\$500 million** in major commercial deals in 2025, with commercial permit valuations surging to **\$1.1 billion**. High-profile transactions like the \$149 million Sawgrass Marriott acquisition highlight robust investor confidence.

Positioned perfectly between:

- **Historic St. Augustine** — tourism powerhouse driving hospitality, retail, and experiential demand.
- **Dynamic Jacksonville** — seamless access to Northeast Florida's business hub, logistics, and workforce.
- **Prestigious Ponte Vedra Beach** — luxury market fueling upscale retail, office, hospitality, PGA HQ and The Players Championship at Sawgrass.

Benefit from booming master-planned communities (Nocatee, World Golf Village, Beachwalk), population influx, top-tier demographics, and major projects including new hotels, retail centers, and mixed-use opportunities.

Whether you're targeting retail, office, industrial, hospitality, or land for development, **St. Johns County** delivers strong absorption, limited competition in key submarkets, and exceptional long-term appreciation.

**Secure your stake in Florida's fastest-growing commercial corridor.**



**CLEARCREEK**  
BROTHERS MANAGEMENT, LLC



**Michael Woods**

Licensed Real Estate Broker  
Clear Creek Brothers Management LLC  
Direct: (980) 262-4200  
Cell: (302) 559-0012  
michael@ccbcre.com  
FL: BK3588582



**Alexandra Papageorge**

Licensed Real Estate Broker  
Clear Creek Brothers Management LLC  
Direct: (980) 262-4200  
Cell: (704) 804-1597  
alexandra@clearcreekbrothers.com  
FL: SL3623743