

# For Lease / 625sf - 5,406sf Office & Retail

5550 Eastex Frwy. Beaumont, TX 77706



**COLDWELL BANKER  
COMMERCIAL**  
ARNOLD AND  
ASSOCIATES



**Expansive Multi-Tenant Flex Property Offers  
Various Suites and Retail Space**

**Great Location - West Beaumont - Dowlen Road Exit  
Quiet Setting, 109 Parking Spaces**



Coldwell Banker Commercial  
Arnold and Associates  
1 Acadiana Court  
Beaumont, TX 77706

TAMMIEY LINSOMB, AGENT  
O: 409-833-5055 M: 409-673-6057  
[tammiey@cbcaaa.com](mailto:tammiey@cbcaaa.com)  
[www.cbcaaa.com](http://www.cbcaaa.com)

©2017 Coldwell Banker Real Estate LLC, dba Coldwell Banker Commercial Affiliates. All Rights Reserved. Coldwell Banker Real Estate LLC, dba Coldwell Banker Commercial Affiliates fully supports the principles of the Equal Opportunity Act. Each Office is Independently Owned and Operated. Coldwell Banker Commercial and the Coldwell Banker Commercial Logo are registered service marks owned by Coldwell Banker Real Estate LLC, dba Coldwell Banker Commercial Affiliates.

# For Lease - 29,241 SF Retail/Office Space

5550 Eastex Frwy. Beaumont, TX 77706



**COLDWELL BANKER  
COMMERCIAL**  
ARNOLD AND  
ASSOCIATES

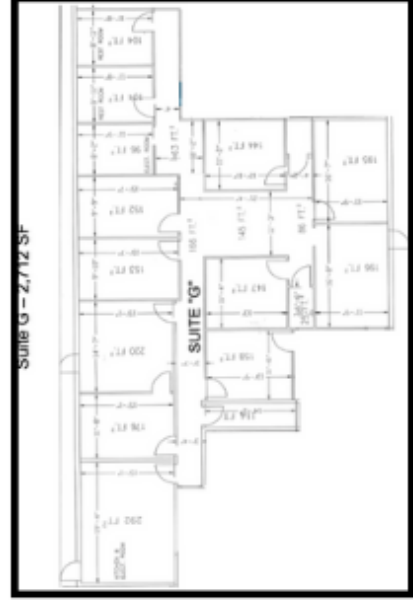

**\$4,068.00 /month**

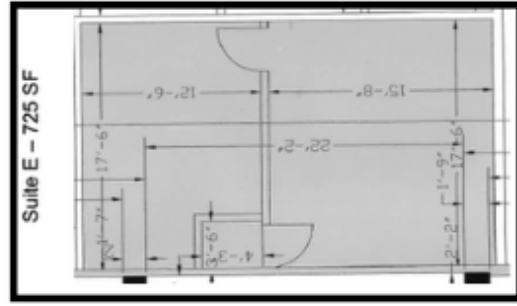

**\$1,087.50/month**

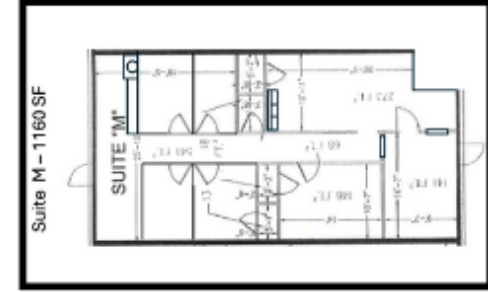

**\$1,740.00/month**

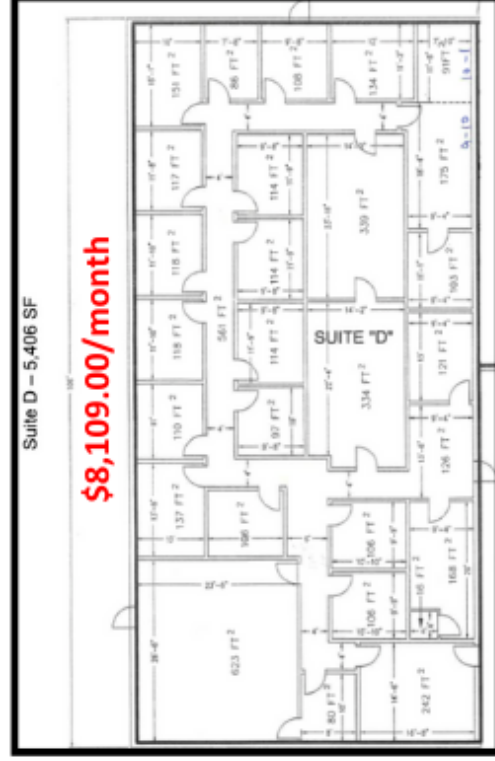

**\$8,109.00/month**

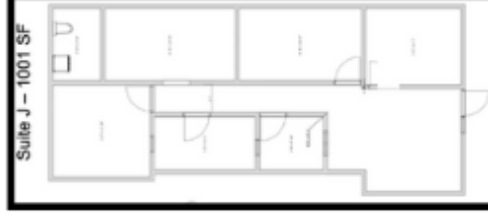

**\$1,501.50/month**

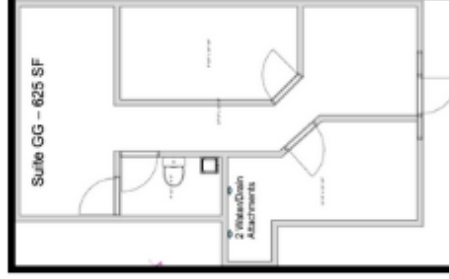

**\$937.50/month**



**TAMMIEY LINSOMB, AGENT**  
O: 409-833-5055 M: 409-673-6057  
tammiey@cbcaaa.com  
www.cbcaaa.com

Coldwell Banker Commercial  
Arnold and Associates  
1 Acadiana Court  
Beaumont, TX 77706

©2017 Coldwell Banker Real Estate LLC, dba Coldwell Banker Commercial Affiliates. All Rights Reserved. Coldwell Banker Real Estate LLC, dba Coldwell Banker Commercial Affiliates fully supports the principles of the Equal Opportunity Act. Each Office is Independently Owned and Operated. Coldwell Banker Commercial and the Coldwell Banker Commercial Logo are registered service marks owned by Coldwell Banker Real Estate LLC, dba Coldwell Banker Commercial Affiliates.

# For Lease - 29,241 SF Office/Retail Space

5550 Eastex Frwy. Beaumont, TX 77706

**COLDWELL BANKER  
COMMERCIAL**  
**ARNOLD AND  
ASSOCIATES**



## Features:

- Multiple Tenant - 1 Story Spaces
- 3.73 parking spaces per 1,000 sf leased
- Built in 1982 with renovations over the years
- Located on 3 acres just off Hwy. 96 North/ Eastex Frwy - 2 miles from IH 10 - Signage on Monument and building Available
- Stucco Front Building
- Easy Access - Two entrances
- Undergoing Renovations!
- Near local retail (Target, Best Buy, Parkdale Mall), restaurants, grocery stores, hotels and 20 minutes from Jefferson County Airport. Close to local industry and refineries.
- New Ownership/ New Management

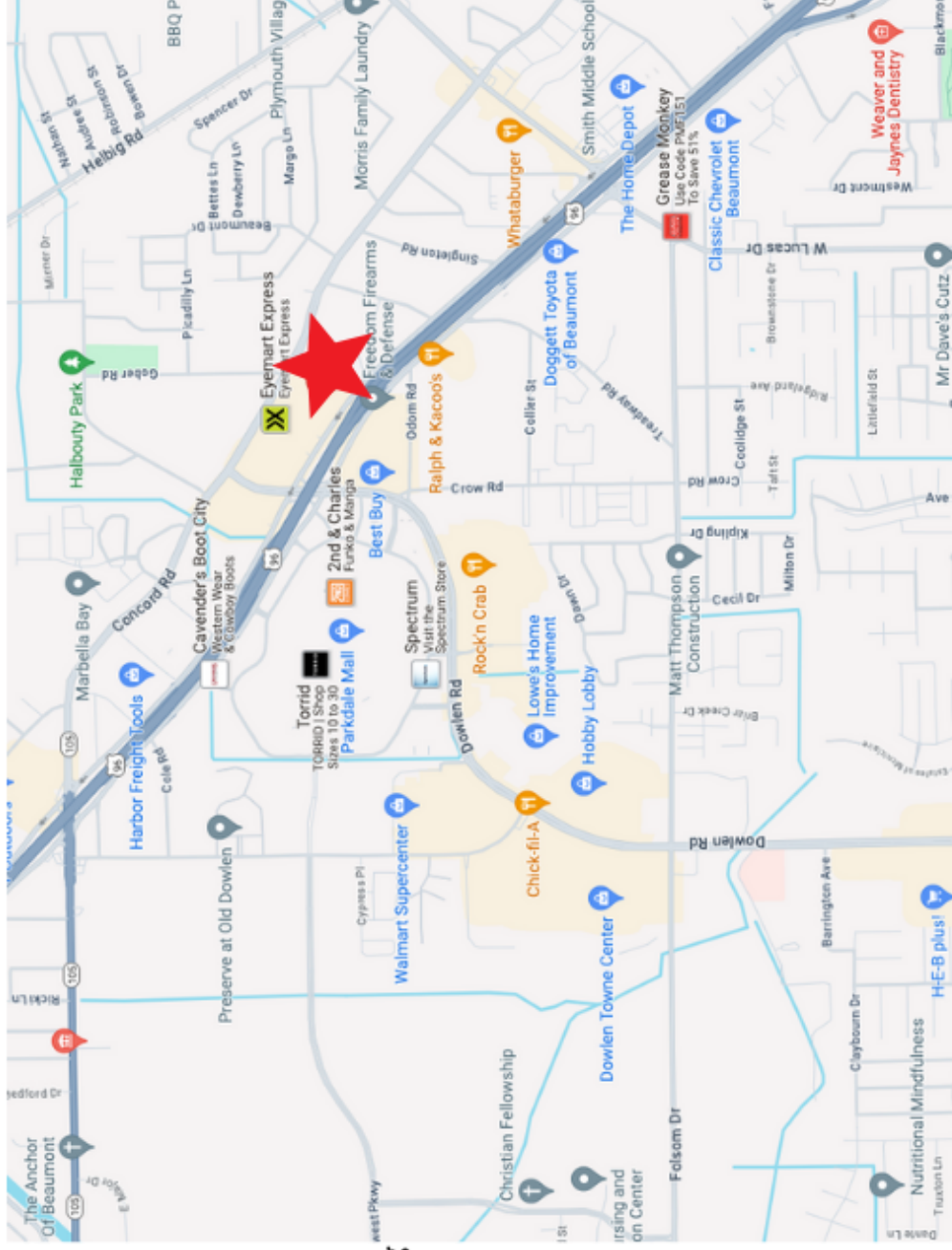

Coldwell Banker Commercial  
Arnold and Associates  
1 Acadiana Court  
Beaumont, TX 77706

**TAMMIEY LINSOMB, AGENT**  
O: 409-833-5055 M: 409-673-6057  
[tammiey@cbcaaa.com](mailto:tammiey@cbcaaa.com)  
[www.cbcaaa.com](http://www.cbcaaa.com)

©2017 Coldwell Banker Real Estate LLC, dba Coldwell Banker Commercial Affiliates. All Rights Reserved. Coldwell Banker Real Estate LLC, dba Coldwell Banker Commercial Affiliates fully supports the principles of the Equal Opportunity Act. Each Office is Independently Owned and Operated. Coldwell Banker Commercial and the Coldwell Banker Commercial Logo are registered service marks owned by Coldwell Banker Real Estate LLC, dba Coldwell Banker Commercial Affiliates.

# For Lease / 625sf - 5,406sf Office & Retail

5550 Eastex Frwy. Beaumont, TX 77706



**COLDWELL BANKER  
COMMERCIAL**  
ARNOLD AND  
ASSOCIATES



**Various Sizes  
Of Space  
Available**

Coldwell Banker Commercial  
Arnold and Associates  
1 Acadiana Court  
Beaumont, TX 77706

**TAMMIEY LINSOMB, AGENT**  
O: 409-833-5055 M: 409-673-6057  
[tammiey@cbcaaa.com](mailto:tammiey@cbcaaa.com)  
[www.cbcaaa.com](http://www.cbcaaa.com)

©2017 Coldwell Banker Real Estate LLC, dba Coldwell Banker Commercial Affiliates. All Rights Reserved. Coldwell Banker Real Estate LLC, dba Coldwell Banker Commercial Affiliates fully supports the principles of the Equal Opportunity Act. Each Office is Independently Owned and Operated. Coldwell Banker Commercial and the Coldwell Banker Commercial Logo are registered service marks owned by Coldwell Banker Real Estate LLC, dba Coldwell Banker Commercial Affiliates.



11/2/2015

## Information About Brokerage Services

Texas law requires all real estate licensees to give the following information about brokerage services to prospective buyers, tenants, sellers and landlords.

- **TYPES OF REAL ESTATE LICENSE HOLDERS:**
  - A **BROKER** is responsible for all brokerage activities, including acts performed by sales agents sponsored by the broker.
  - A **SALES AGENT** must be sponsored by a broker and works with clients on behalf of the broker.
- A **BROKER'S MINIMUM DUTIES REQUIRED BY LAW** (a listed) is the person or party that the broker represents;
  - file the interests of the client above all others, including the broker's own interests;
  - inform the client of any material information about the property or transaction received by the broker;
  - answer the client's questions and present any offer to or counter-offer from the client; and
  - treat all parties to a real estate transaction honestly and fairly.

### A LICENSE HOLDER CAN REPRESENT A PARTY IN A REAL ESTATE TRANSACTION:

**AS AGENT FOR OWNER (SELLER/LANDLORD):** The broker receives the property owner's agent through an agreement with the owner, usually in a written listing to sell or property management agreement. An owner's agent must perform the broker's minimum duties above and must inform the owner of any material information about the property or transaction known by the agent, including information disclosed to the agent or subject to the buyer or buyer's agent.

**AS AGENT FOR BUYER/TENANT:** The broker becomes the buyer's/tenant's agent by agreeing to represent the buyer, usually through a written representation agreement. A buyer's agent must perform the broker's minimum duties above and must inform the buyer of any material information about the property or transaction known by the agent, including information disclosed to the agent by the seller or seller's agent.

**AS AGENT FOR BOTH - INTERMEDIARY:** To act as an intermediary between the parties the broker must first obtain the written agreement of each party to the transaction. The written agreement must state who will pay the broker and, in conspicuous bold or underlined print, set forth the broker's obligations as an intermediary. A broker who acts as an intermediary:
 

- Must treat all parties to the transaction impartially and fairly;
- May, with the parties' written consent, appoint a different licensee holder associated with the broker to each party (owner and buyer) to communicate with, provide opinions and advice to, and carry out the instructions of each party to the transaction.
- Must not, unless specifically authorized in writing to do so by the party, disclose:
  - that the offeror will accept a price greater than the price submitted in a written offer; and
  - any confidential information or any other information that a party specifically instructs the broker in writing not to disclose, unless required to do so by law.

**AS SUBAGENT:** A licensee holder acts as a subagent when acting as a buyer in a transaction without an agreement to represent the buyer. A subagent can assist the buyer but does not represent the buyer and must place the interests of the owner first.

**TO AVOID DISPUTES, ALL AGREEMENTS BETWEEN YOU AND A BROKER SHOULD BE IN WRITING AND CLEARLY ESTABLISH:**

- The broker's duties and responsibilities to you, and your obligations under the representation agreement.
- Who will pay the broker for services provided to you, when payment will be made and how the payment will be calculated.

**LICENSE HOLDER CONTACT INFORMATION:** This notice is being provided for information purposes. It does not create an obligation for you to use the broker's services. Please acknowledge receipt of this notice below and retain a copy for your records.

<b>Coldwell Banker Commercial Arnold and Associates</b>	0519783	0519783	0519783	0519783
Licensed Broker Firm Name of Primary Assumed Business Name	License No.	Equal Housing Opportunity	Equal Housing Opportunity	Equal Housing Opportunity
Designated Broker of Firm	License No.	Phone	Phone	Phone
<b>Shari Arnold</b>	0319221	409-833-5055	409-833-5055	409-833-5055
License Supervisor of Sales Agent	License No.	Phone	Phone	Phone
<b>Tammiey Linscomb</b>	031461	409-833-5055	409-833-5055	409-833-5055
Sales Agent/Associate's Name	License No.	Phone	Phone	Phone
<b>Buyer/Tenant/Client/Landlord Interests</b>	Date			

Regulated by the Texas Real Estate Commission

Information available at [www.trec.texas.gov](http://www.trec.texas.gov)  
 (409) 1-8 DARE  
 For more information, please contact the Texas Real Estate Commission at (505) 224-3400, (505) 224-3400, or [www.trec.texas.gov](http://www.trec.texas.gov)