

#3 (RIGHT MIDDLE BUILDING)

835 Minnie St
Jacksonville, FL 32204

NOVEMBER 7, 2024



Inspector
Jordan Berman

Jordan Berman

HI9212

904-352-3733

Admin@newinspections.com



INSPECTIONS

Inspector

Juan Vega

Juan L. Vega

HI8278

904-352-3733

Admin@newinspections.com

TABLE OF CONTENTS

1: Inspection Details	
2: Exterior	4
3: Roof	4
4: Water Heater	10
5: Interior Areas	13
6: Electrical	16
7: Heating, Cooling	21
8: Kitchen	28
9: Bathroom(s)	33
10: Plumbing	35
11: Attic, Roof Structure, & Ventilation	42
12: Structural Components	43
13: Other	44
14: Sewer Scope	45
15: Important Information/Limitations	47
Standards of Practice	49
	52

SUMMARY



MINOR



MODERATE



SIGNIFICANT

These summary pages are not the entire report. The complete report may include additional information of interest or concern to you. It is strongly recommended that you promptly read the complete report. For information regarding the negotiability of any item in this report under the real estate purchase contract, contact your Florida real estate agent or an attorney.

- ⊖ 2.2.1 Exterior - Walkways, Patios & Driveways: Settled Concrete at exterior
- ⊖ 2.3.1 Exterior - Siding, Flashing & Trim: Damage at siding/Trim
- 🔧 2.4.1 Exterior - Windows: Missing/damaged Window Screens
- 🔧 2.5.1 Exterior - Exterior Doors: Loose threshold at main entry door
- 🔧 2.5.2 Exterior - Exterior Doors: Wood Decay - Lower Door Trim
- 🔧 2.9.1 Exterior - Vegetation, Grading, Drainage & Retaining Walls: Negative Slopes in the grade
- 🔧 2.11.1 Exterior - Hose Bibbs: Inoperable hose bib
- ⚠️ 3.2.1 Roof - Roof Coverings: Roof concerns/leaks
- ⊖ 4.2.1 Water Heater - Water Heater Condition: Older water heaters
- ⊖ 4.2.2 Water Heater - Water Heater Condition: No drain pan installed under water heater
- ⊖ 5.5.1 Interior Areas - Windows: Aged windows show general wear and tear from the older age
- 🔧 5.6.1 Interior Areas - Interior Doors: Door does not latch properly
- 🔧 5.6.2 Interior Areas - Interior Doors: Door rubs against the frame
- ⊖ 5.10.1 Interior Areas - Surfaces - Overall: Dead roaches
- ⊖ 6.11.1 Electrical - Electrical Outlets: Tester shows open ground at electrical outlets
- ⊖ 6.11.2 Electrical - Electrical Outlets: 2 Prong Outlet
- ⊖ 6.12.1 Electrical - GFCI & AFCI: No GFCI in bathroom
- ⊖ 7.3.1 Heating, Cooling - Inside Unit: No overflow safety switch or drain pan under air handler
- ⊖ 7.6.1 Heating, Cooling - Air Supply/Registers: Fungi growth near air vent
- ⊖ 7.9.1 Heating, Cooling - Condensate Drain Pipe: Condensate Drain Pipe Terminated Near Foundation and damaged at siding connection
- 🔧 8.7.1 Kitchen - Ranges/Ovens/Cooktops: Anti-Tip Bracket Missing at ovens
- 🔧 8.7.2 Kitchen - Ranges/Ovens/Cooktops: Inoperable Oven Light
- 🔧 9.3.1 Bathroom(s) - Plumbing Fixtures (faucets, shower heads, etc.): Missing faucet Aerator
- ⊖ 9.5.1 Bathroom(s) - Shower walls and floor: Wear at bathrooms/showers
- ⊖ 9.7.1 Bathroom(s) - Toilets: Toilet loose at floor connection and fungi growth/leak
- ⊖ 12.2.1 Structural Components - Foundation: Settlement
- ⊖ 13.3.1 Other - General Wear and Tear: General Wear and Tear
- ⊖ 14.2.1 Sewer Scope - Drain System: Sewer scope

1: INSPECTION DETAILS

Information

General: Occupancy

Occupied, Furnished

General: In Attendance

Tenant, Client Representative, Inspector

General: Approximate Age of Building

Over 70 years

General: Type of Building

Multi-Family

General: Weather Conditions

Cloudy

General: Temperature at the Time of Inspection

Greater Than 65 Degrees, 80+ Degrees

General: Rain in last 3 days

Yes

General: Older Home

This home is 70 years or older and the home inspector considers this while inspecting. It is common to have areas that no longer comply with current code. This is not a new home and this home cannot be expected to meet current code standards. While this inspection makes every effort to point out safety issues, it does not inspect for code. It is common that homes of any age will have had repairs performed and some repairs may not be in a workmanlike manner. Some areas may appear less than standard. This inspection looks for items that are not functioning as intended. It does not grade the repair. It is common to see old plumbing or mixed materials. Sometimes water signs in crawlspaces or basements could be years old from a problem that no longer exists. Or, it may still need further attention and repair. Determining this can be difficult on an older home. Sometimes in older homes, there are signs of damage to wood from wood-eating insects. Having this is typical and fairly common. If the home inspection reveals signs of damage you should have a pest control company inspect further for activity and possible hidden damage. Always consider hiring the appropriate expert for any repairs or further inspection.

2: EXTERIOR

Information

General Info: Driveway

Street Parking

General Info: Siding Material

Stucco, Block

General Info: Soffit & Fascia Material

Not Present

General Info: Vegetation Obscuring Wall(s) Visibility?

Partial

General Info: Exterior Maintenance Video
Walkways, Patios & Driveways: Driveway Material

Concrete



Exterior - Home Maintenance



General Info: Exterior Photos



Limitations

General Info

UPPER LEVEL SURFACES

FYI - Due to their height from the ground, the upper-level exterior surfaces and details of the sections of the home were physically inaccessible for thorough review. Reportable conditions may be present which I was unable to observe. The State of Florida Standards of Practice states that a representative sample of exterior components shall be inspected on each side of the home when multiple pieces make up an item or component (i.e. cladding, windows, overhangs, etc.). We try to ensure that all portions are inspected but height from the ground, vegetation, or other factors may prevent full accessibility or visibility of some items.

Siding, Flashing & Trim

SIDING FLASHING AND TRIM INFORMATION

The walls and wall cladding were inspected looking for significant damage, presence of proper flashings, and potential water entry points, etc. No reportable deficiencies were visibly present at the time of inspection unless otherwise noted in this report.

Vegetation, Grading, Drainage & Retaining Walls

GRADING LIMITATIONS

The performance of the grading and lot drainage is limited to the conditions existing at the time of the inspection only. I cannot guarantee this performance as conditions constantly change. Heavy rain or other weather conditions may reveal issues that were not visible or foreseen at the time of inspection. Furthermore, items such as leakage in downspouts and gutter systems are impossible to detect during dry weather and can add moisture to the soil in the area around the foundation. The inspection of the grading and drainage performance in relation to moisture infiltration through foundation walls or under slabs, therefore, is limited to the visible conditions at the time of inspection, and evidence of past problems. I recommend consulting with the sellers as to any previous moisture intrusion into the home, as well as reading over the Sellers Disclosure which should list any such issues.

Recommendations

2.2.1 Walkways, Patios & Driveways

Moderate

SETTLED CONCRETE AT EXTERIOR

The concrete has settled at the exterior. The concrete is uneven or has sunken downwards in areas, which can cause a potential tripping hazard. Recommend repairing the concrete as needed or monitoring and being cautious of this.

Recommendation

Contact a qualified concrete contractor.



2.3.1 Siding, Flashing & Trim

Moderate

DAMAGE AT SIDING/TRIM

Damage was present to the siding and/or trim in the areas pictured below. Recommend repairing the siding to ensure proper drainage and to allow for normal wear and tear.

Recommendation

Contact a qualified professional.



2.4.1 Windows

Minor

MISSING/DAMAGED WINDOW SCREENS

Some missing and damaged window screens noted. Recommend repair as desired to reduce possible pest entry when the windows are open.

Recommendation

Contact a qualified professional.



2.5.1 Exterior Doors

Minor

LOOSE THRESHOLD AT MAIN ENTRY DOOR

The lower threshold is loose at the main entry door. Recommend repair, so the threshold is secure.

Recommendation

Contact a qualified handyman.



2.5.2 Exterior Doors

 Minor

WOOD DECAY - LOWER DOOR TRIM

Wood decay noted at unit 825 exterior door's lower door jamb. Recommend repair to allow for normal wear and tear.

Wood decay is common for exterior doors with only a small roof overhang above it or where wind driven rain can enter. This can allow water to run down the seams during wind driven rain. This is a exterior rated door, so this is okay, but wood decay is commonly found at these doors after enough time. Adding storm doors or extending the roof overhang can help reduce this.

Recommendation

Contact a qualified professional.



825

2.9.1 Vegetation, Grading, Drainage & Retaining Walls

 Minor

NEGATIVE SLOPES IN THE GRADE

There are a few negative slopes that does not appear to drain water away from the home. Recommend correcting the grading or drainage so water is diverted away from the structure. Typically dirt needs to be added, compacted and sloped away from the home to allow for better drainage or underground drains can be added.

Recommendation

Contact a qualified handyman.



2.11.1 Hose Bibbs

 Minor

INOPERABLE HOSE BIB

The hose bibbs were inoperable at the right side of the home, likely due to the repiping of some of the plumbing components (the original pipes are disconnected, so the new pipes can be installed). This is typically okay, as it is assumed this is due to the supply pipe replacement. Recommend asking the seller for additional info.

Recommendation

Contact the seller for more info



right side of home

3: ROOF

Information

General Info: Roof & Gutter Maintenance
Video

General Info: Roof Covering Material
Rubber Roof Membrane

General Info: Inspection Method
Walked the Roof Where Possible

Roof & Gutter Maintenance



General Info: Roof Covering Install Date
(If Permit Found)

2014

General Info: General Views of Roof



General Info: Roof Limitations

The inspection of the roof and its covering material is limited to the conditions on the day of the inspection only. The roof covering material, visible portions of the roof structure from within the attic (if applicable), and interior ceilings, were inspected looking for indications of current or past leaks. Future conditions and inclement weather may reveal leaks that were not present at the time of inspection. Any deficiencies noted in this report with the roof covering or indications of past or present leaks should be evaluated and repaired as needed by a licensed roofing contractor.

Skylights, Chimneys & Other Roof Penetrations: Roof Protrusions Information

The plumbing stack vents, their related rain boots, and other roof penetrations were inspected by looking at their clearance, the integrity of their boots, for proper installation, or any significant defects. No reportable conditions were present at the time of inspection unless otherwise noted in this report.

Limitations

Roof Flashings

ROOF FLASHING INFORMATION & LIMITATIONS

Visible portions of the flashings were inspected looking for significant deficiencies (drip edge, sidewall, headwall, counter, step, etc - as applicable). **Typically most areas of flashings are not visible as they are covered by the roof covering material and/or the wall cladding** (as applicable), and these areas are excluded from this inspection. Therefore functionality has to be determined by looking for moisture intrusion on ceilings where the flashing was presumed to be in place, or on the roof decking from within the attic (as accessible). No reportable conditions were observed at visible portions, at the time of inspection, unless otherwise noted in this report.

Recommendations

3.2.1 Roof Coverings

 Significant

ROOF CONCERNS/LEAKS

Water stains noted on the ceilings and walls in multiple areas. The stains had low moisture levels according to the moisture meter, but in my personal opinion this likely will leak during very excessive rains or in the some-what near future. The roof covering shows multiple repairs around the roof. Sealants were applied, as well as elastomeric or silicone roof coatings, but this was a lot of different areas. The chimneys are no longer active, but still need to be maintained. The rain caps show corrosion. There is multiple areas of standing water. While some standing water can be common for flat roofs, but was a lot of different areas and the roof covering is bubbling in areas and moves when stepped on. Recommend further evaluation by a roofing contractor and repair or replace as needed.

Recommendation

Recommend monitoring.

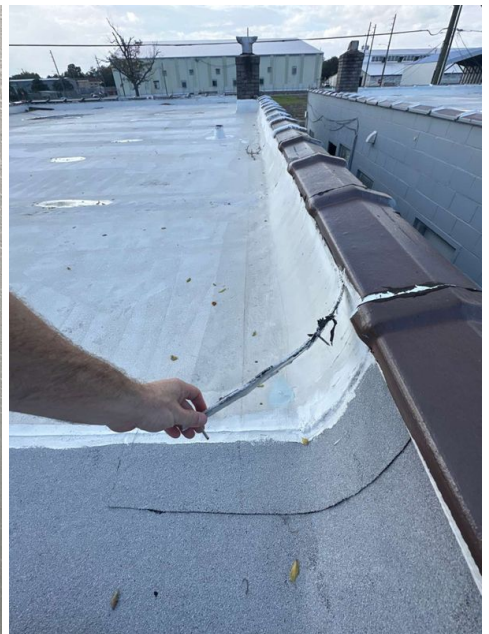
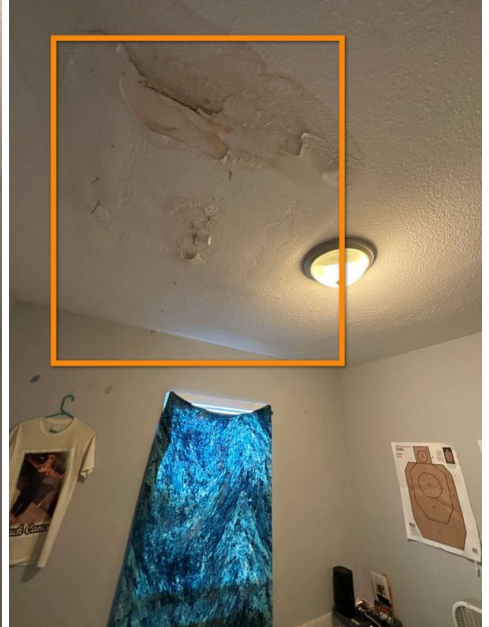

827



4: WATER HEATER

Information

General Info: Water Heater Location

Interior Closet

General Info: General View of Water Heater(s)

The water heater(s) appeared to be functioning properly at the time of inspection.

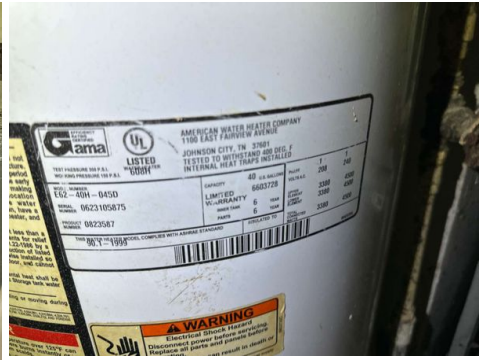
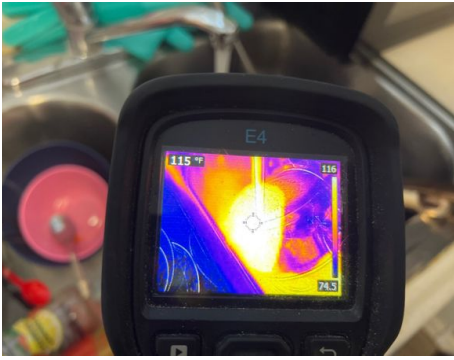

General Info: Discharge Pipe Present

A TPR valve discharge pipe was present. No deficiencies were observed unless otherwise noted in this report.

Water Heater Condition: Tank Water Heater

Most manufacturers have life expectancies of 10-14 years. This is for your information.

Recommendations

4.2.1 Water Heater Condition

OLDER WATER HEATERS

The water heaters are older (2006 and 2014). The water heaters were operable during the inspection, but are older units. Recommend monitoring and budgeting for future replacement.

Recommendation

Recommend monitoring.

Moderate



827

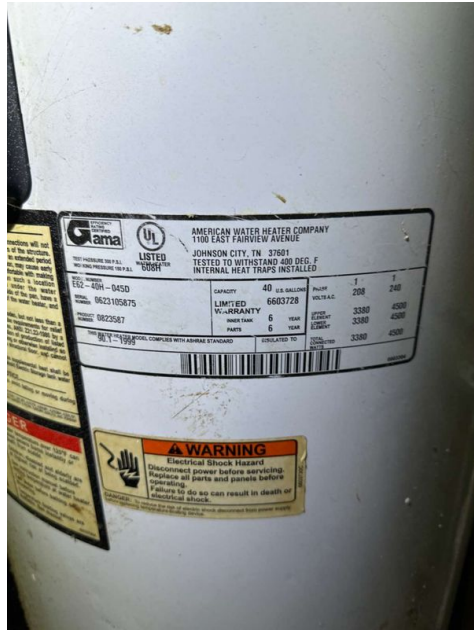

825

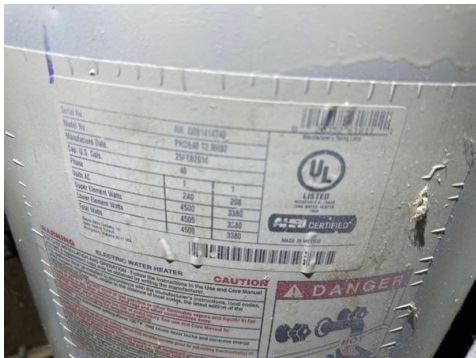

4.2.2 Water Heater Condition

Moderate

NO DRAIN PAN INSTALLED UNDER WATER HEATER

Unit 827s water heater is located inside the home or is near components that could be effected if the water heater leaks overtime. Recommend installing a drain pan underneath the unit as a precautionary measure in case of leaks (no drain pan present).

Recommendation

Contact a qualified professional.



5: INTERIOR AREAS

Information

General Info: Interior Maintenance Video

Interior - Home Maintenance



General Info: View of Interior Rooms

General view of interior rooms.

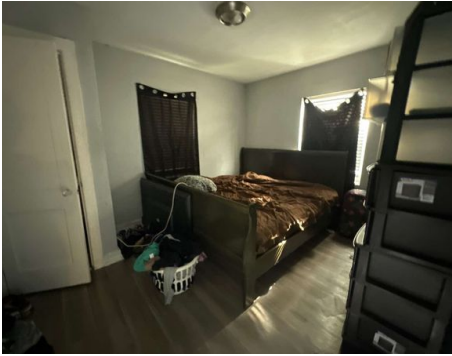
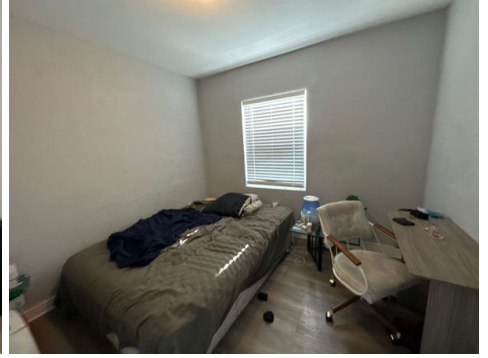
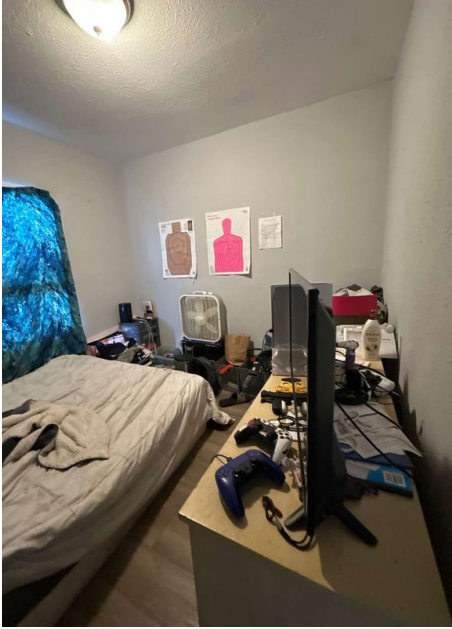

Limitations

Walls

WALLS INFORMATION

Visible portions of the interior walls were inspected looking for signs of moisture infiltration, settlement cracking, significant damage, or other significant deficiencies. No reportable deficiencies were observed at the time of inspection unless otherwise noted in this report.

Walls

WALL/CEILING CRACK(S) INFORMATION/LIMITATIONS

Cracks are reported on by their presence, location, and visual condition as existing at the time of inspection only. I can not render a professional opinion as to a cracks severity, cause, or whether it has been recently active. **Only a Structural Engineer can render a judgement on the severity and cause of settlement; movement; thermal expansion; and cracks; and they should be consulted as desired.**

Ceilings

CEILINGS INFORMATION

The ceilings throughout the home were inspected looking for moisture intrusion/staining due to roof leaks or leaking plumbing pipes. Settlement cracks, and significant defects were also inspected for. No reportable conditions or moisture stains were visibly present at the time of inspection unless otherwise noted in this report.

Ceilings

MOISTURE STAINS INFORMATION

The ceilings throughout the home were inspected looking for moisture stains from roof leaks, plumbing leaks, or other sources. No moisture stains were present on the ceilings at the time of inspection unless otherwise noted in this report.

Windows

WINDOWS INFORMATION

The windows were inspected by operating a representative number (I will try and operate every window in the home, but access, height restrictions and personal belongings may block accessibility to some). Their operation was tested, along with looking for damage, broken glass, failed seals, etc. No reportable deficiencies were present unless otherwise noted in this report.

Windows

GLASS SEAL FAILURE LIMITATIONS

Reporting on double pane glass seal failure is not required by the State of FL Standards of Practice, and lies beyond the scope of a home inspection, as glass may not show signs of seal failure at the time of inspection, but may become visible later due to changes in conditions. Desiccant material in the glass spacer can absorb moisture in between the panes, essentially masking seal failure. Also, changes in weather conditions (high humidity, etc.) may reveal seal failure that was not visible at the time of inspection. Seal failure is where the double pane glass loses its adhesion with the inner spacer, allowing moisture and debris in between the panes of glass. We will report on any insulated glass units that were showing signs of seal failure at the time of inspection, but this should not be relied upon as a complete listing of affected units. If glass seal failure is a concern, you are advised to seek the services of a window or glass repair contractor.

Floors

FLOORS INFORMATION

Visible portions of the floors throughout the home were inspected looking for significant floor deficiencies. No reportable conditions were visibly present at the time of inspection unless otherwise noted in this report.

Surfaces - Overall

SURFACES INFORMATION

Visible portions of the interior wall, floor, and ceiling surfaces were inspected looking for indications of moisture intrusion, settlement, or other significant defects. Cosmetic and minor deficiencies are not typically reported on, but may be noted while looking for significant defects, any listing of these items should not be construed as an all-inclusive listing. No reportable conditions were observed at the time of inspection unless otherwise noted in this report.

Recommendations

5.5.1 Windows

Moderate

AGED WINDOWS SHOW GENERAL WEAR AND TEAR FROM THE OLDER AGE

There were windows present that were difficult to operate, did not operate as intended, and/or had other age related deficiencies. Some windows were tight and difficult to open, some windows were difficult to lock. The plastic window pane trim is loose or missing in areas. Some water stains and minor fungi growth were noted at the window frames, likely from condensation overtime which is common for windows of this age. Having older windows is okay, but perfect function should not be expected. Some replacement window panes noted, so there has been repairs. Recommend consider upgrading the windows in the future.

Recommendation

Contact a qualified window repair/installation contractor.



827

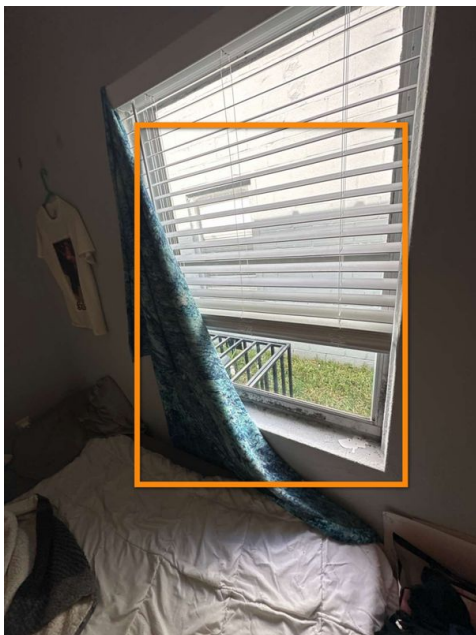

827



827 (tight)

5.6.1 Interior Doors

DOOR DOES NOT LATCH PROPERLY

 Minor

Unit 827s bedroom closet doors latching assembly (deadlatch) does not latch to the strike plate on the door frame. I was able to pull the door open when the door was fully shut. Needs adjustment.

Recommendation

Contact a qualified handyman.



827

5.6.2 Interior Doors

DOOR RUBS AGAINST THE FRAME

 Minor

Unit 825s bedroom closet door rubs against or hits the door frame when opened/closed, making operation slightly difficult. Needs adjustment or repair to allow for a better clearance.

Recommendation

Contact a qualified handyman.

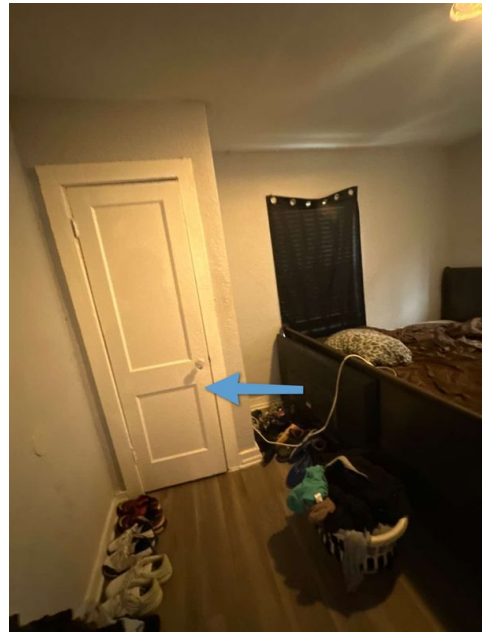

825

5.10.1 Surfaces - Overall

Moderate

DEAD ROACHES

Dead roaches found in many areas. Recommend further evaluation by pest control company and repair or treat as needed.

Recommendation

Contact a qualified professional.

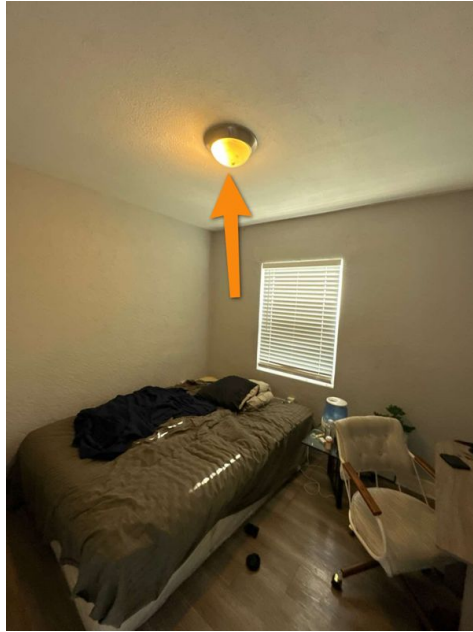

825

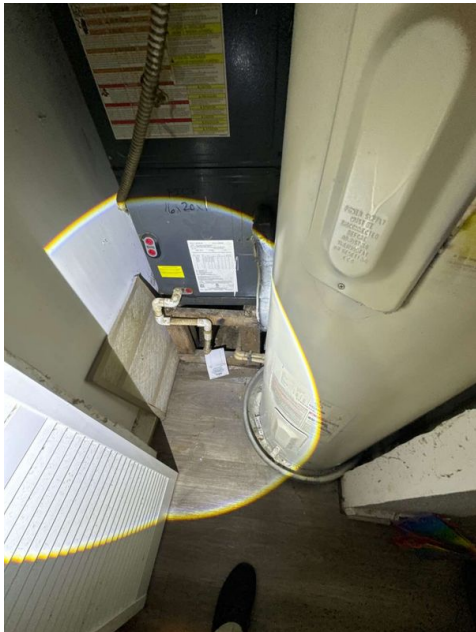

6: ELECTRICAL

Information

General Info: Electrical Maintenance Video

General Info: Electrical Panel / Service Equipment Location
Hallway

General Info: Electrical Panel Manufacturer
Siemens

Home Maintenance - Electrical



General Info: Service Entrance Type
Overhead Service Drop

General Info: Visible Branch Wiring Type
NM Sheathed Cable, Braided Cloth NM

General Info: 15 & 20amp Branch Wiring Metal Type
Copper

General Info: Pictures of Electrical Panel/Service Equipment

The main electrical panel (called service equipment when it contains the service disconnect) was inspected looking for any wiring deficiencies or damage that may be present in the panel. No indications of reportable conditions were present at the time of inspection unless otherwise noted in this report.

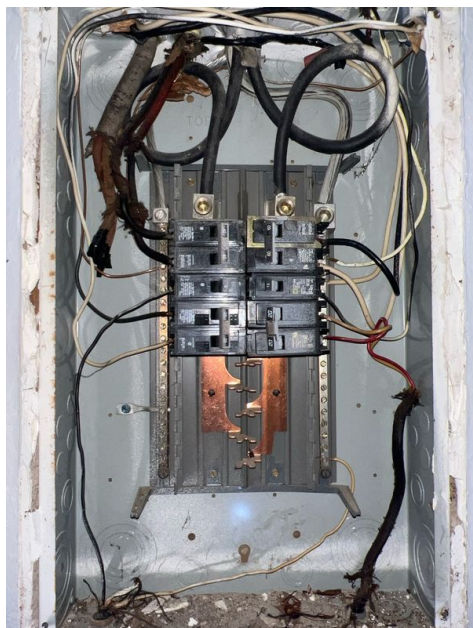
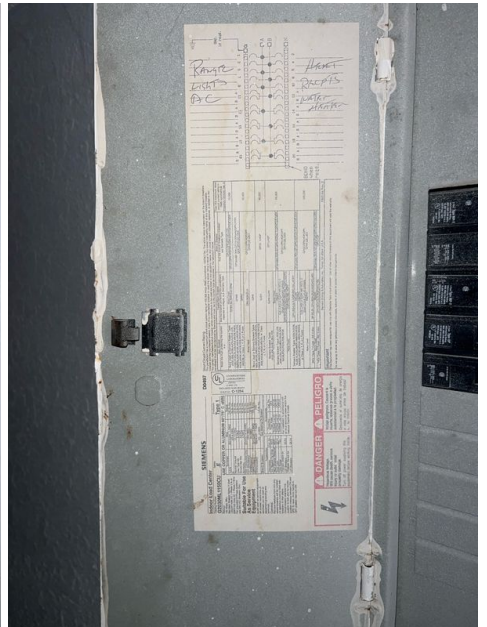

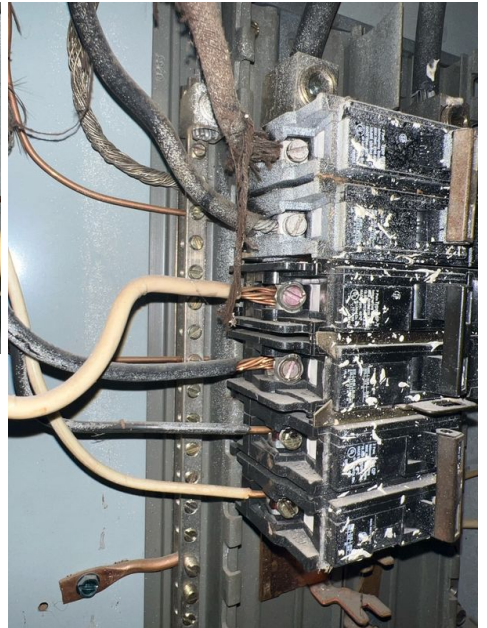
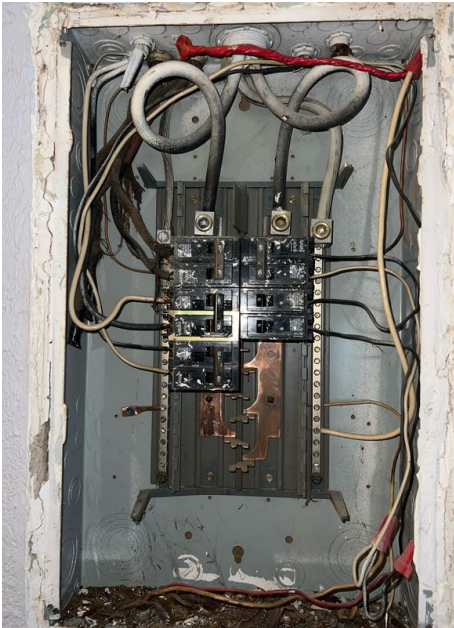
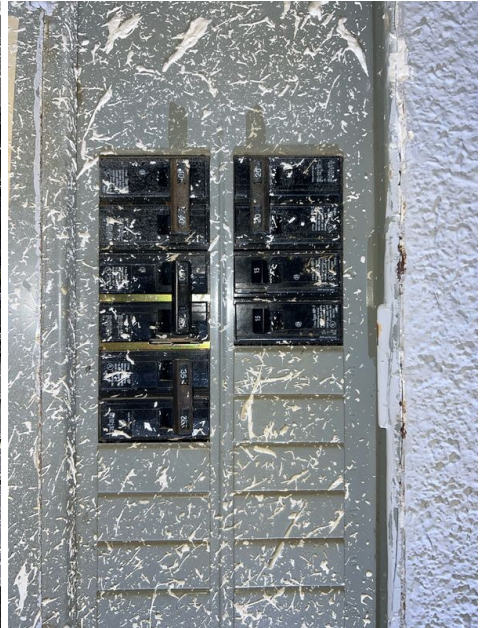
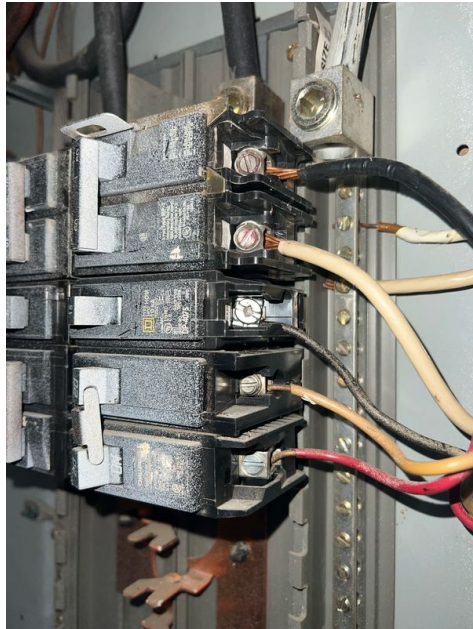
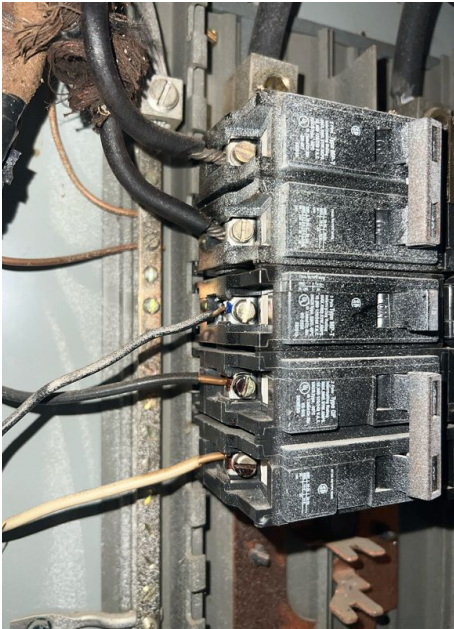

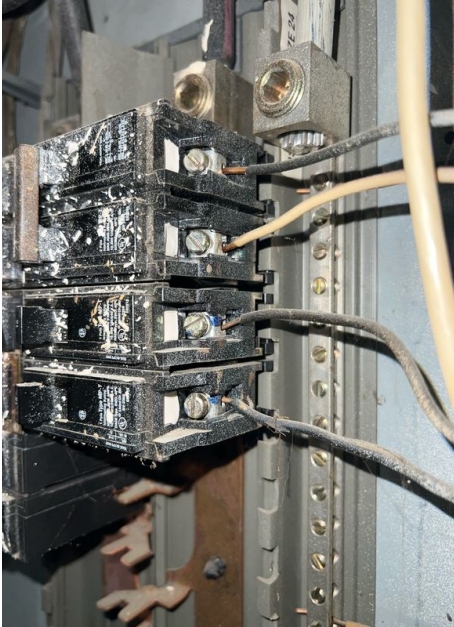

General Info: No Hot Spots Observed with IR Camera

No hot spots or anomalies were observed in the electrical panel, under current loading conditions, during the inspection.

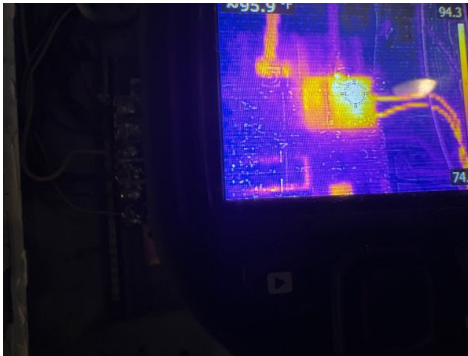

General Info: Main Breaker / Service Disconnect Location

At Main Breaker by Exterior Meter

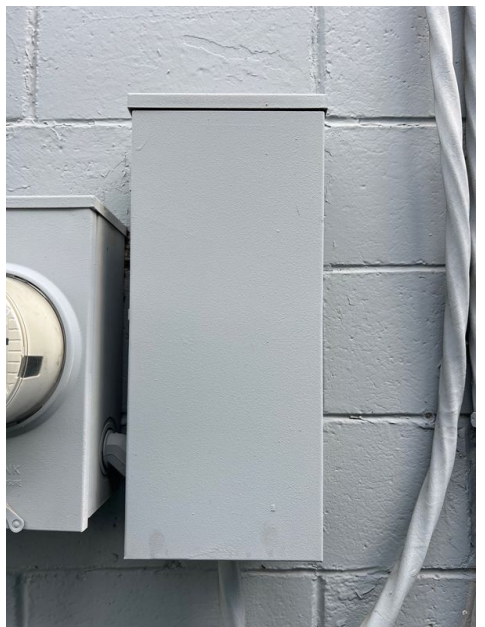



General Info: Service Amperage

150amps 120/240VAC



Smoke Detectors: Recommend testing the smoke detectors.

The smoke detector should be tested at common hallway to bedrooms upon moving into home. We do not test the smoke detectors for function.

Limitations

General Info

BREAKERS INFORMATION

The breakers were inspected looking for any visible signs of damage due to arcing, heat, etc. Corresponding conductors were inspected looking for multiple lugging, sizing, damage, etc. No deficiencies were present at the time of inspection unless otherwise noted in this report.

General Info

GFCI INFORMATION

Ground Fault Circuit Interrupter (GFCI) is a protection feature that allows a circuit or receptacle to "trip" or "shut off" if as little as a 5 milliamp differential is detected between the "hot" and "neutral" conductors. This protection is recommended for receptacles within 6 feet of a sink's edge, or where something plugged into a receptacle could come into contact with water, including: bathrooms, kitchens, on the exterior, in garages, laundry rooms, and basements and crawl spaces. Although GFCI protection may not have been required in some or all of these areas when the home was built, their installation is highly recommended and is typically inexpensive.

GFCI protection is only tested for if the circuit is protected by a visible receptacle containing a "Test" and "Reset" button, or a GFCI breaker in the electrical panel, as the UL (underwriters laboratory) only recognizes testing this protection by depressing the "Test" button on the receptacle or breaker, and not by the use of a polarity tester. As well, testing with a polarity tester can trip a hidden GFCI leaving the circuit inoperable. Please see above for area(s) that were not able to be tested or confirmed for GFCI protection, and these area(s) are recommended to be tested for GFCI protection at a time when personal belongings have been removed from the home.

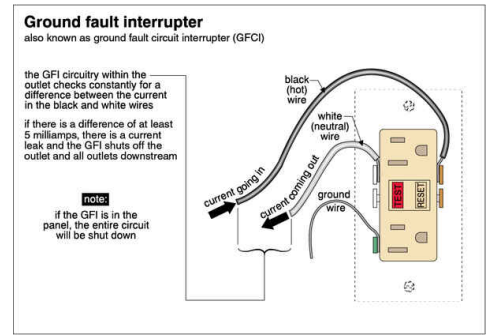

General Info

BRANCH WIRING INFORMATION

The branch wiring was inspected at visible portions looking for any significant deficiencies or defects that could be a fire and/or safety hazard; including but not limited to: connections made outside of a junction box, wiring terminations, open junction boxes, damage, the wiring material, improper support, etc. The majority of branch feeders are not visible due to being behind wall and ceiling coverings, insulation, etc. No significant deficiencies were visibly present at the time of inspection unless otherwise noted in this report.

General Info

LOW VOLTAGE SYSTEMS/WIRING NOT INSPECTED

Any low voltage systems in the home were not inspected and are excluded from this inspection. Including but not limited to: phone/telecom systems, cable coaxial systems, ethernet wiring, alarm systems, low voltage lighting and applicable wiring, etc.

Smoke Detectors

SMOKE ALARMS INFORMATION

Smoke alarms are recommended to be installed in each sleeping room, (1) outside of each sleeping room(s), and one per level including habitable attics and basements. **I recommend replacing the batteries and testing the smoke alarms before spending your first night in the home.** Several other recommendations relating to smoke alarms and fire safety are recommended by the NFPA, and can be found here:

<http://www.nfpa.org/public-education/by-topic/smoke-alarms/installing-and-maintaining-smoke-alarms>

Smoke Detectors

SMOKE ALARMS NOT TESTED

The smoke alarm units were not tested due to the possibility of them being integrated with the whole structure fire alarm system. I recommend consulting with the sellers as to their operation as well as confirming they are operational.

Recommendations

6.11.1 Electrical Outlets

Moderate

TESTER SHOWS OPEN GROUND AT ELECTRICAL OUTLETS

The electrical outlets pictured below showed an improper ground according to the receptacle tester. An open ground outlet can cause an electrical surge to the connected device resulting in damage or electrical shock. Recommend further evaluation and repair by a qualified electrical contractor.

Recommendation

Contact a qualified professional.



825

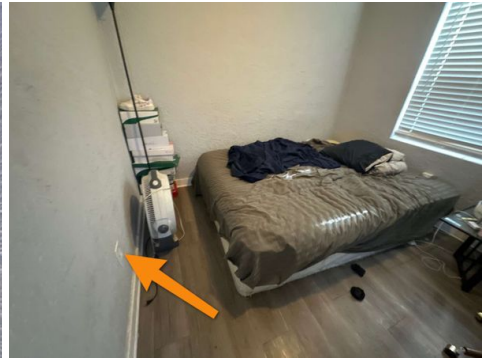

825

6.11.2 Electrical Outlets

Moderate

2 PRONG OUTLET

Unit 827s bedroom has a 2 prong receptacle. This type of outlets do not have a ground, which can be common for older homes (lack of grounds in the wiring). Recommend upgrading for safety.

Recommendation

Contact a qualified electrical contractor.

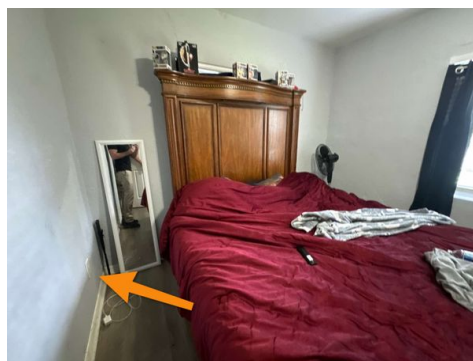
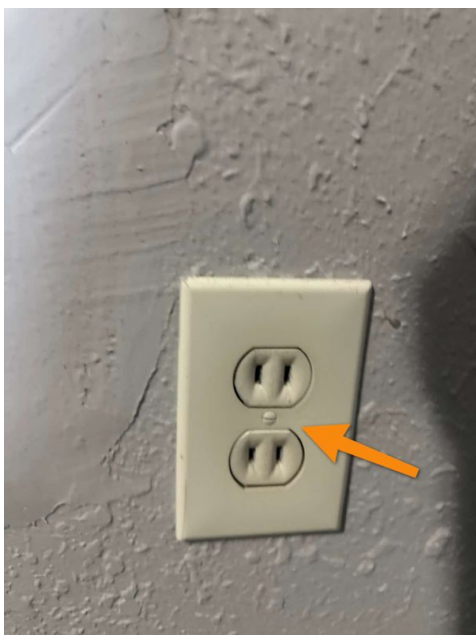

827

6.12.1 GFCI & AFCI

Moderate

NO GFCI IN BATHROOM

Recommend installing ground fault circuit interrupter (GFCI) protection to the electrical outlet in unit 827s bathroom. While this may have not been required when the home was built, upgrading is recommended for safety.

Recommendation

Contact a qualified professional.

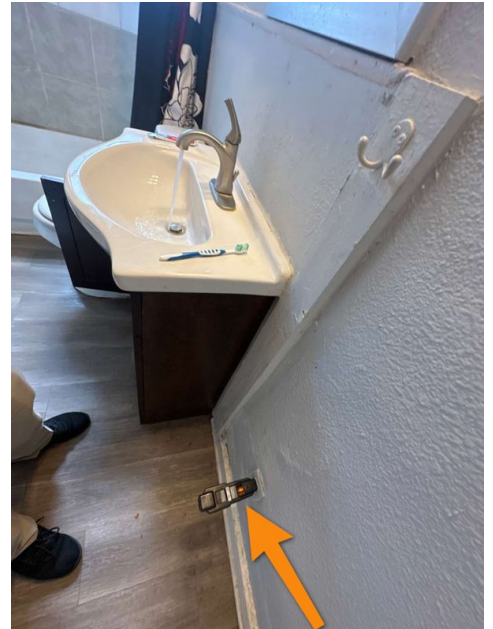

825

7: HEATING, COOLING

Information

General Info: Manufacturer
Goodman

General Info: Energy Source & Type
Electric Condensing Unit (Heat Pump)

General Info: HVAC Maintenance Video

HVAC Maintenance



Watch on

General Info: General View of HVAC System

The interior and exterior unit(s) were inspected visually and tested by ensuring they responded to normal operating controls (at the thermostat), and that conditioned air was produced. The unit(s) responded to normal operating controls and no indications of deficiencies were observed at the time of inspection, unless otherwise noted in this report.



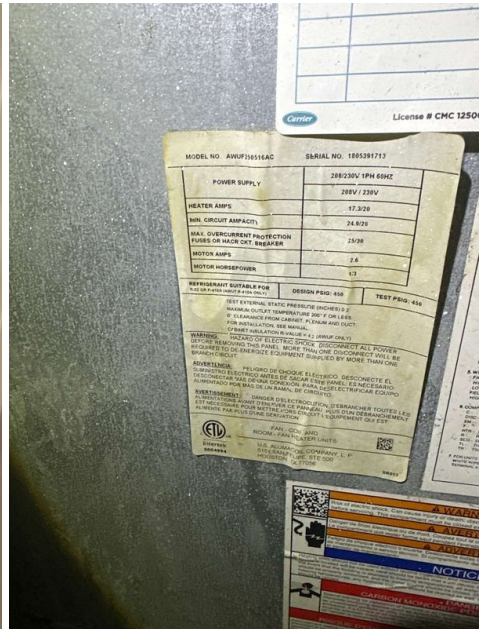

827

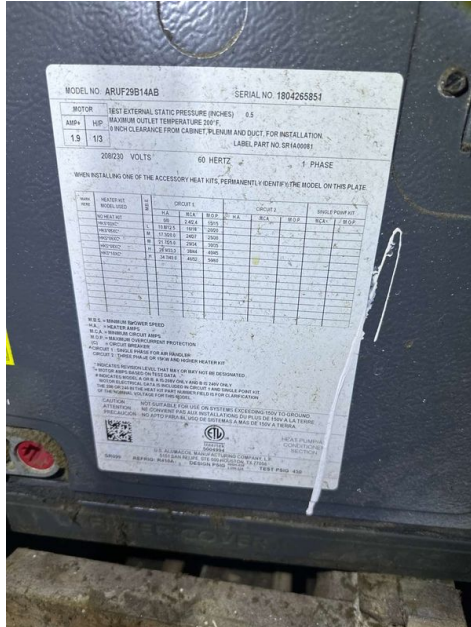

825

General Info: Air/Return Supply Information

An infrared camera was used to show the system responded to normal operating controls, at the time of inspection. **These images are not intended to show the exact temperature differential produced, the efficiency, or performance of the system, which lies beyond the scope of a home inspection.** HVAC thermometers (wet bulb) are required for accurate readings, and measurement points would be carried out at a different location by an HVAC contractor. Typical temperature differentials between return and supply air is 10 - 20 degrees in cooling mode, and 15 - 25 degrees in heating mode. Several factors can affect these numbers, such as, but not limited to: indoor ambient air temperature, exterior ambient air temperature, humidity, cleanliness of the air filter and evaporator, etc.

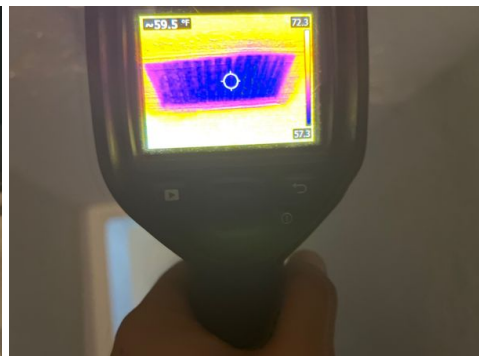

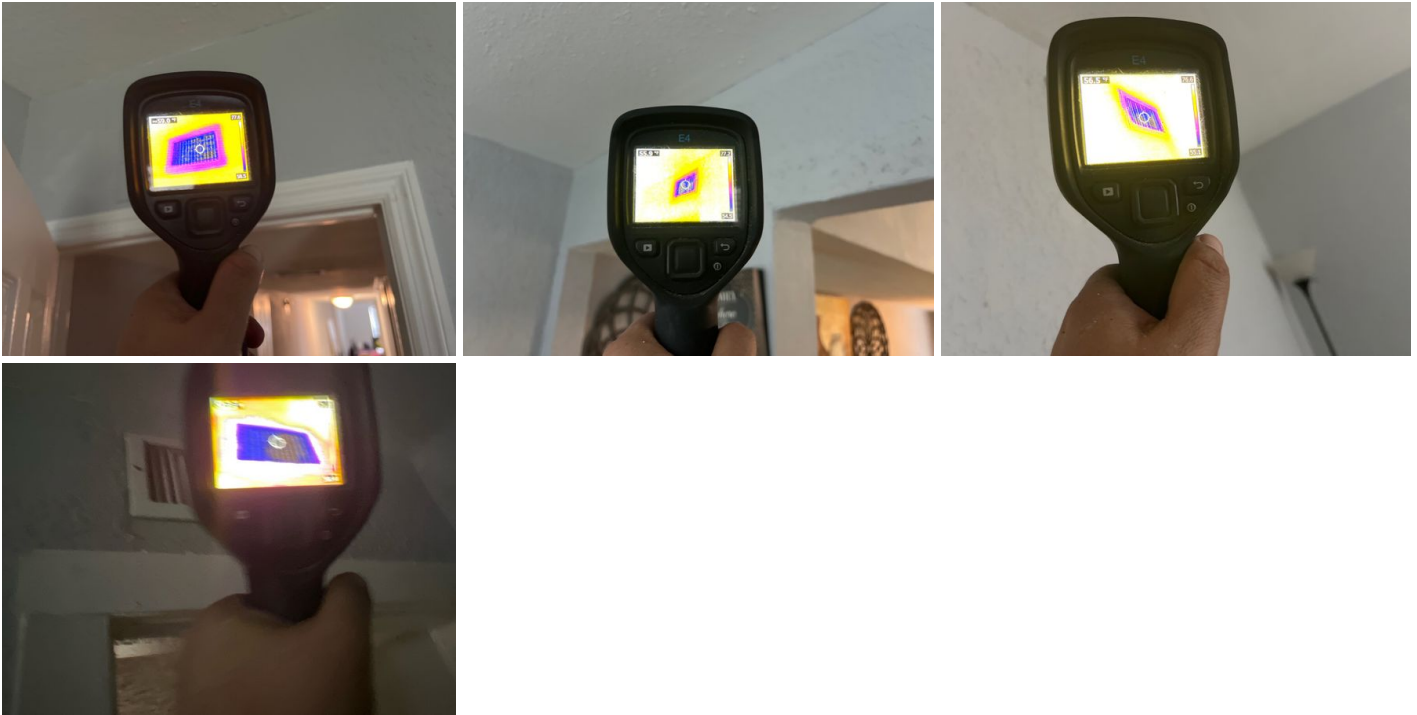

Air Return/Filter: Temperature Reading

A temperature reading of the return air was taken at the time of inspection, to provide a baseline to compare output temperatures to, showing the system responded to normal operating controls.



Air Return/Filter: Filter/Plenum Information

The return air grille, air filter, and return air plenum were inspected at visible portions looking for any significant deficiencies, gaps in the plenum, dirty filter(s), or an accumulation of dust. I recommend changing the filter every 30 days - 3 months depending on the style of filter used. This is one of the most important "maintenance" items you can perform as a dirty filter puts additional strain on the air handler and may cause damage to the unit.

Recommendations

7.3.1 Inside Unit

Moderate

NO OVERFLOW SAFETY SWITCH OR DRAIN PAN UNDER AIR HANDLER

There is either no drain pan or no overflow safety float switch under the air handler in unit 827. This does not allow for any leak protection in case the unit leaks in the future. Recommend consider adding a overflow safety float switch or drain pan or at least being cautious of this and monitoring periodically. There are also signs of previous leaks. Recommend further evaluation and repair as needed.

Recommendation

Contact a qualified professional.



825

7.6.1 Air Supply/Registers

 Moderate
FUNGI GROWTH NEAR AIR VENT

Fungi growth noted around unit 827s bathroom air vent, likely from typical condensation overtime. Recommend further evaluation and treatment or repair as needed.

Recommendation

Contact a qualified professional.



827

7.9.1 Condensate Drain Pipe

 Moderate
CONDENSATE DRAIN PIPE TERMINATED NEAR FOUNDATION AND DAMAGED AT SIDING CONNECTION

The condensate drain pipe terminated at or near the foundation of the home. This can allow water to saturate the soil in this area, possibly entering back into or under the structure. Extending the drain pipe, away from the foundation, is recommended to be conducted by a qualified person as needed. The condensation drain pipe at the left side of the home is damaged at the siding, so water is running down the siding here and needs repair so water does not seep to the interior.

Recommendation

Contact a qualified professional.



right side of home

8: KITCHEN

Information

Ranges/Ovens/Cooktops: Energy Source
Electric

General Info: General View of Kitchen



General Info: Under Sink Pictures Kitchen



General Info: Cooktop Information

All cooktop heating elements were turned to "High", and were functional at the time of inspection. No deficiencies were observed at the time of inspection unless otherwise noted in this report.



General Info: Oven Information

The oven was operated by placing into "Bake" mode, but then quickly turned off. We do not test ovens for full heat or full function, but we do turn the oven on to ensure it is heating. We test the stove, but not the oven fully due to the risks of potentially leaving the oven on after the inspection (we test the heat, but do not leave the oven on to pre heat to a desired temperature). The liability is simply too much of a risk to test the oven during an extended period of time to pre heat the oven. Recommend testing the unit to ensure proper function as a precautionary measure or asking the seller for additional info.



General Info: Fridge General Pictures



Undersink Plumbing - Kitchen: Plumbing Information

The supply and drain pipes were inspected looking for leaks, improper installation, and other deficiencies. No reportable conditions were observed at the time of inspection unless otherwise noted in this report.

Recommendations

8.7.1 Ranges/Ovens/Cooktops

**ANTI-TIP BRACKET MISSING AT OVENS**

An anti-tip bracket was not present for the the range (for all 8 units, not just this report). An anti-tip bracket prevents the range from tipping over, if weight is applied to an open oven door, such as a child stepping or sitting on the door. Ranges contain a warning label on the inside of the oven door with more information. This bracket can be purchased at home improvement stores for approximately ten dollars. The installation of an anti-tip bracket is recommended for safety, but a minor concern.

Recommendation

Contact a qualified professional.



8.7.2 Ranges/Ovens/Cooktops

**INOPERABLE OVEN LIGHT**

The oven light was inoperable during the inspection. Recommend replacing the light bulb or repair if necessary.

Recommendation

Contact a handyman or DIY project



9: BATHROOM(S)

Information

General Info: General View of Bathrooms

General view of the bathrooms.

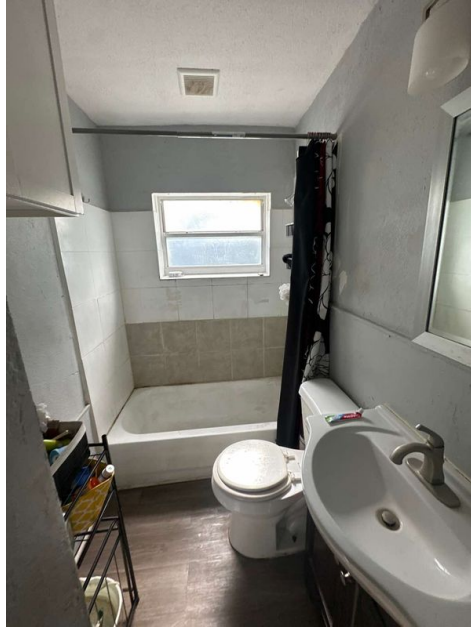

General Info: Ventilation Sources

Ventilation Fan(s)



General Info: Bathroom Plumbing Pictures



Toilets: Toilet(s) Information

The toilets were inspected by flushing them to ensure they were flushing adequately and to determine no leaks were present at the water supply line or tank location. No deficiencies were observed at the time of inspection unless otherwise noted in this report.

Limitations

General Info

SINK PLUMBING INFORMATION

The visible portions of the sink plumbing was inspected by running water through the drain pipe for over one minute and looking for leaks from the drain pipe / trap assembly, water supply lines, and areas underneath of the sink area (ceiling below/basement/crawl space). Other significant defects are also looked for with the plumbing. No reportable conditions were observed at the time of inspection unless otherwise noted in this report.

Shower walls and floor

SHOWER WALLS INFORMATION

The shower walls were inspected looking for any significant damage or areas that could allow for water infiltration behind the walls. No reportable conditions were present at the time of inspection unless otherwise noted in this report.

Counters and Cabinets

CABINET & COUNTERTOP(S) INFORMATION

The cabinets and countertops were inspected by looking for significant defects. No deficiencies were observed at the time of inspection unless otherwise noted in this report.

Ventilation

VENTILATION INFORMATION

The bathroom ventilation is reported on by its source; windows or ventilation fans are acceptable forms of ventilation for bathrooms containing a tub and/or shower. If fans are present they will be tested by operating the switch and listening for proper air flow. Although windows in a bathroom can substitute for a fan, a fan is still recommended due to not utilizing windows in colder winter months. No deficiencies were observed with the ventilation at the time of inspection unless otherwise noted in this report.

Recommendations

MISSING FAUCET AERATOR

Unit 827s bathroom sink faucet had an erratic flow. The aerator (the screen at the terminating end of the faucet that mixes air with water) is missing. Recommend repair as needed.

[DIY Video Link](#)

Recommendation

Contact a qualified plumbing contractor.

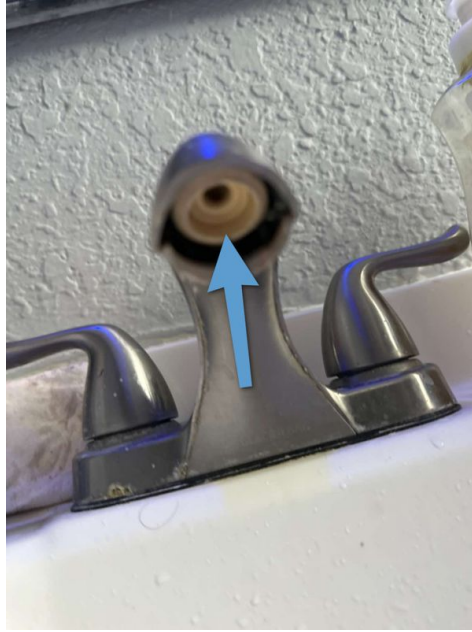
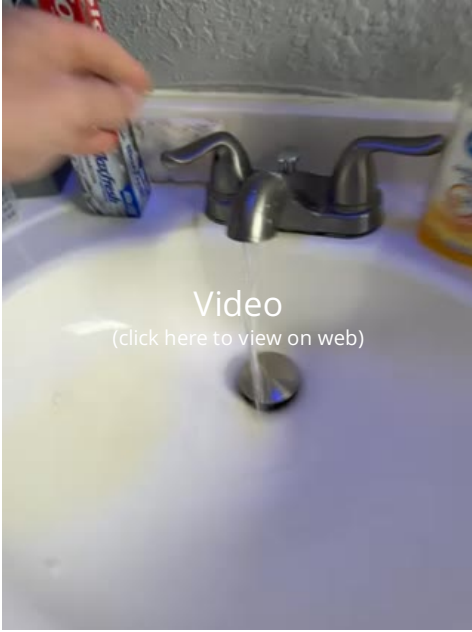

827

9.5.1 Shower walls and floor

Moderate

WEAR AT BATHROOMS/SHOWERS

A paint type of refinish was applied to the shower walls and bathtub in unit 827, which is okay, but this coating has failed in areas and is chipped and peeling. Some areas need caulking as well. There is also wear at unit 825s bathtub, as well as standing water in both units bathrooms from an inadequate drainage pitch. Recommend repair as needed.

Recommendation

Contact a qualified professional.

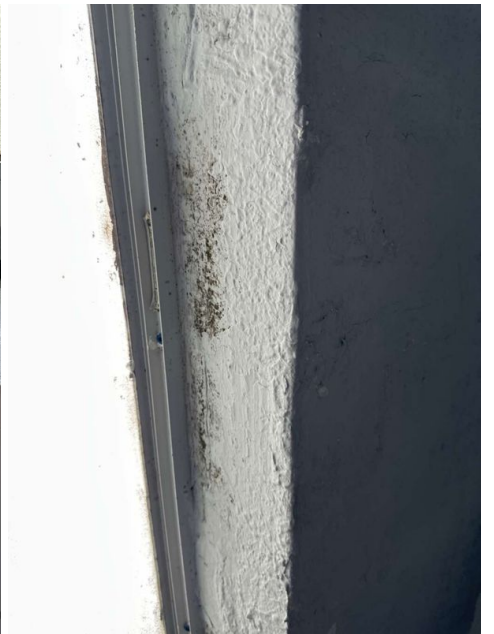

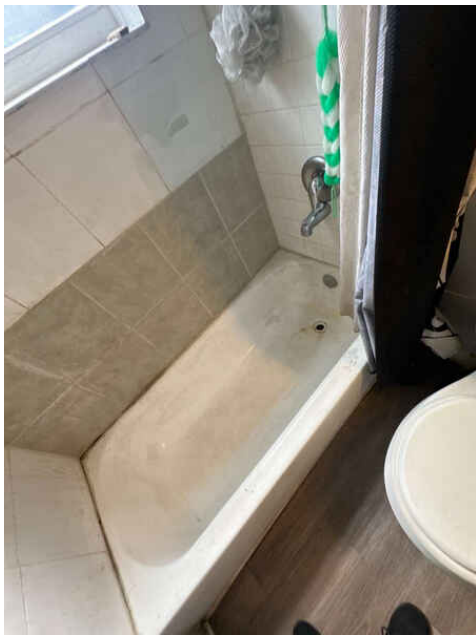

825

9.7.1 Toilets

Moderate

TOILET LOOSE AT FLOOR CONNECTION AND FUNGI GROWTH/LEAK

Unit 827s bathroom toilet is loose from the floor connection. Repairs may involve re-setting the toilet on a new wax seal. There is also fungi growth and a lot of water stains at the baseboard behind the toilet, so the toilet could be leaking from time to time if moved too far or there is excessive water overspray during showers, but needs further evaluation and repair by a plumber.

Recommendation

Contact a qualified plumbing contractor.



827



827

10: PLUMBING

Information

General Info: Water Pressure (Approx.)
Not Tested

General Info: Water Distribution Pipe Material (Visible Portions)
CPVC

General Info: DWV Material Type (Visible Portions)
PVC

General Info: Main Gas Shut Off Valve Location
N/A

General Info: Plumbing Maintenance Video

Plumbing Maintenance



General Info: Main Shut Off Valve Location
Exterior Right, Exterior Left



Main Cleanout: Cleanout Location
Left Exterior

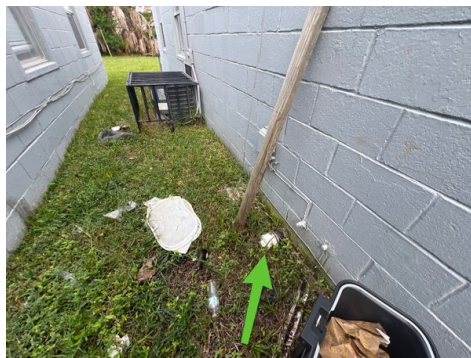

Functional Flow: Flow Information

Water was ran from multiple faucets simultaneously to gauge that there was not a significant reduction in flow as a result of doing so. No significant reduction occurred at the time of inspection unless otherwise noted in this report.

Functional Drainage: Drainage Information

Water was ran through all drains in the home for an extended period of time to determine if functional drainage was occurring. No hindered drainage was present at the time of inspection unless otherwise noted in this report. Lived-in conditions can not be adequately replicated during an inspection and I have no control of future drainage conditions due to lived-in usage (solids being flushed down the system, etc.).

11: ATTIC, ROOF STRUCTURE, & VENTILATION

Information

General Info: Inspection Method

Not Inspected

General Info: Roof Structure Type

Not Fully Visible

General Info: Roof-Type

Flat

General Info: Insulation Type

Undetermined

General Info: Ventilation Types

No True Ventilation Source

Limitations

General Info

ATTIC NOT PRESENT - LOW ROOF PITCH

Due to the low pitch and roof design of this portion of the home, no attic was present. Any items located between the interior ceilings and roof are excluded from this inspection (electrical wiring, insulation level, framing, etc.)

Roof Structure/Framing

LIMITED ACCESS

The attic access was limited due to the type of construction, insulation and obstructions. Not all areas were visible or accessible.

Ventilation

VENTILATION LIMITATIONS

The attic ventilation was reported on by a visual inspection of the above designated ventilation sources, and looking for indications of improper ventilation. Measurements of ventilation sources are beyond the scope of a home inspection and were not conducted. No indications of inadequate ventilation was observed at the time of inspection unless otherwise noted in this report.

The attic and roof cavity ventilation is a frequently-misunderstood element of residential construction. All roof cavities are required to have ventilation. The general default standard is 1 sq ft of ventilation for every 150 sq ft of attic area and ideally, this comes from at least 60% lower roof cavity ventilation and 40% upper, but this is a wild over-simplifications of the subject. As a good guiding principle the most important elements for healthy attic spaces are:

- Make sure the ceiling between the living space and the attic is airtight.
- Ventilate consistently across the whole lower part of the roof cavity with low, intake soffit venting.
- Upper roof cavity venting is less important and if over-installed can exacerbate heat loss into the attic from the living space.
- Avoid power ventilators which can depressurize the attic and exacerbate air migration from the house into the attic.

For more information, please see: <https://www.greenbuildingadvisor.com/article/lstibureks-rules-for-venting-roofs>

12: STRUCTURAL COMPONENTS

Information

General: Foundation

Poured concrete

General: Floor Structure

Slab

General: Foundation Type

Monolithic Slab

General: Method used to observe**Crawlspace**

No crawlspace

General: Wall Structure

Cinder Block

Recommendations

12.2.1 Foundation

SETTLEMENT

The floors are not level and clearly has been settlement, but this is an older home, so the settlement and movement of the home appeared normal for the age and appeared realistically okay. This is an older home though, so the settlement should be monitored.

Recommendation

Recommend monitoring.



13: OTHER

Recommendations

13.3.1 General Wear and Tear

Moderate

GENERAL WEAR AND TEAR

This is not a new home, so the home has general wear and tear that can be common for its age. You should be aware of the general condition. We inspect with realistic expectations for the age of the home, but here are some photos of some of the more noticeable wear and tear items that were noted.

Recommendation

Contact a qualified professional.

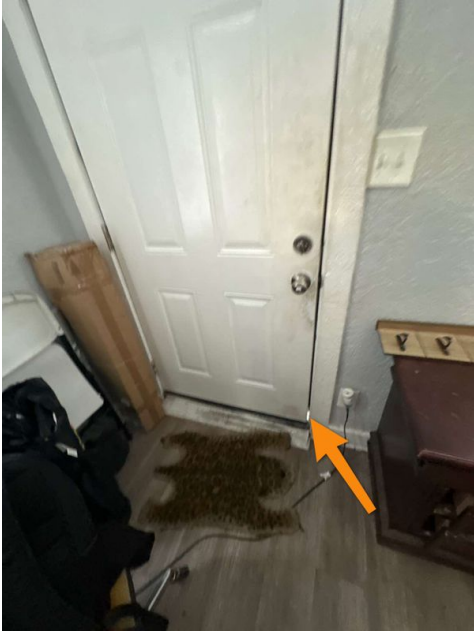

825



14: SEWER SCOPE

Information

Drain System: Main Drain Access Location

Left side of home

Overview: Overview

NEW Home Inspection services was retained for a survey of the building main sewer line in an effort to identify areas of suspect clogs or damage and to document the areas for further review. Further investigations of these areas or destructive testing may reveal additional conditions that were not readily visible at time of inspection. This report is based on information obtained at the site at the given date and time. We document our findings with videos and visual photographs of the areas. The purpose of any sewer scan service is to document problems in sewer lines. Our inspection is designed to comply with accepted industrial standards when at all possible and will be performed in a non-destructive manner, however at times destructive testing may be necessary. Prior to any destructive testing, the client will be notified and approval by the client prior to commencing additional testing. Our inspection is not meant to be a guarantee of all affected areas; only those that reveal themselves to our sewer camera, visual inspection and our experience.

This report is for the exclusive use of our Client and is not intended for any other purpose. The report is based on the information available to us at this time as described in the report. Should additional information become available at a later date, we reserve the right to determine the impact, if any, the new information may have on our discovery and recommendations and to revise our opinions and conclusions if necessary and warranted. We can make no representations regarding conditions that may be present but concealed or inaccessible during the survey. With

access and an opportunity for inspection, additional reportable conditions may be discovered. Inspection of the inaccessible areas will be performed at an additional cost after access is provided.

Orientation

We will describe the locations of the various features of this property, left or right, etc., as though we were standing in street looking at the front of building or looking at it as the cover photo.

This report includes:

Sewer inspection digital report with explanations.

Overview: Comment key and definitions

Moderate = The area while perhaps functioning as intended is in need of **moderate** repair, service; is showing signs of wear or deterioration that could result in an adverse condition at some point in the future; or considerations should be made in upgrading the area to enhance the proper function. Items falling into this category can frequently be addressed by a **qualified contractor** and are not considered routine maintenance or DIY items.

Major = The area noted poses a Major concern to the sewer lateral and or main drain line of the home.

The areas noted that are **Not** functioning as intended, or needs further evaluation by a specialized qualified licensed plumbing contractor or can cause problems to the sewer lines. Areas that can be repaired to satisfactory condition may not need replacement.

Overview: Analysis and Recommendations

We recommend that your maintenance team carefully review this report. Then, with reference to the imagery and areas denoted in the report, these areas should be physically located and given a thorough visual examination. When warranted, these areas should be subjected to a destructive investigation to confirm the analysis and determine the possible detrimental effects the blockage may have caused. We recommend a specialist conduct additional testing as needed to evaluate the reliability of system. Any destructive testing performed as authorized by the client must be repaired by others and is not considered in this scope of our work. Services such as interpretation of visual patterns documented in this report and any remedial and replacement recommendations should be performed by knowledgeable experts.

We recommend all areas we locate in this report showing blockage and other anomalies should be evaluated further to find out the cause and repaired. Our recommendations are not intended as criticisms of the building, but rather as professional opinions regarding conditions that we observed.

Our reports are designed to be clear, concise and useful. Please review this report carefully. If there is anything you would like us to explain, or if there is other information you would like, please feel free to call us as we would be happy to answer any questions.

Limitations

General

CLIENTS REPORT

This report is for the person(s) named in the Client section only. Unauthorized use is prohibited without said Client(s) and NEW Home Inspections permission. Liability under this report is limited to the party identified on the cover page of this report.

General

SEWER SCAN

A Sewer Scan was requested of the main drain line from house to city or private sewer connection. The following is a report of our findings. If a video was completed, it will be provided under attachment section.

Recommendations

14.2.1 Drain System

Moderate

SEWER SCOPE

There was a cleanout at the side of the home, which showed cast iron drain pipes that were corroded (and a lot of roaches inside). The cleanout was not connected well (I was able to pull it right out). This is an odd place for a cleanout, as usually the drain pipe leads to the sewer and into the home, but this was at the side of the home and was the only cleanout found. Cast iron drain pipes do have a life expectancy, but did show PVC piping inside the home in areas, so not all is cast iron. Recommend further evaluation and repair as needed by a plumber.

Recommendation

Contact a qualified plumbing contractor.



15: IMPORTANT INFORMATION/LIMITATIONS

Information

Important Information / Limitations: Inspection Overview

NEW Home Inspections strives to perform all inspections in substantial compliance with the Standards of Practice as set forth by the State of Florida ([FL Standards of Practice](#)). As such, we inspect the readily accessible, visually observable, installed systems and components of the home as designated in these Standards of Practice. When systems or components designated in the Standards of Practice were present but were not inspected, the reason(s) the item was not inspected will be stated. This inspection is neither technically exhaustive or quantitative.

There may be comments made in this report that exceed the required reporting of the FL Standards of Practice, these comments (if present) were made as a courtesy to give you as much information as possible about the home. Exceeding the Standards of Practice will only happen when we feel we have the experience, knowledge, or evidence to do so. There should be no expectation that the Standards of Practice will be exceeded throughout the inspection, and any comments made that do exceed the standards will be followed by a recommendation for further evaluation and repairs by applicable tradespeople.

This report contains observations of those systems and components that, in our professional judgement, were not functioning properly, significantly deficient, or unsafe. **All items in this report that were designated for repair, replacement, maintenance, or further evaluation should be investigated by qualified tradespeople within the clients contingency period**, to determine a total cost of said repairs and to learn of any additional problems that may be present during these evaluations that were not visible during a "visual only" Home Inspection.

This inspection is not equal to extended day-to-day exposure and will not reveal every concern or issue that may be present, but only those significant defects that were accessible and visible at the time of inspection. This inspection can not predict future conditions, or determine if latent or concealed defects are present. The statements made in this report reflect the conditions as **existing at the time of inspection only**, and expire at the completion of the inspection. The limit of liability of NEW Home Inspections and its employees, officers, etc. does not extend beyond the day the inspection was performed. As time and differing weather conditions may reveal deficiencies that were not present at the time of inspection, including but not limited to: roof leaks, water infiltration into crawl spaces or basements, leaks beneath sinks, tubs, and toilets, water running at toilets, the walls, doors, and flooring, may be damaged during moving, etc. Refer to the State of Florida Standards of Practice (linked to above), and the Inspection agreement regarding the scope and limitations of this inspection.

This inspection is **NOT** intended to be considered as a **GUARANTEE OR WARRANTY, EXPRESSED OR IMPLIED, regarding the operation, function, or future reliability of the home and its components. AND IT SHOULD NOT BE RELIED ON AS SUCH.** This report is only supplemental to the Sellers Disclosure and Pest (WDO) Inspection Report and should be used alongside these documents, along with quotes and advice from the tradespeople recommended in this report to gain a better understanding of the condition of the home and expected repair costs. Some risk is always involved when purchasing a property and unexpected repairs should be anticipated, as this is unfortunately, a part of home ownership. One Year Home Warranties are sometimes provided by the sellers, and are **highly recommended** as they may cover future repairs on major items and components of the home. If a warranty is not being provided by the seller(s), your Realtor can advise you of companies who offer them.

Important Information / Limitations: Notice to Third Parties

Notice to Third Parties: This report is the property of NEW Home Inspections. The Client(s) and their Direct Real Estate Representative named herein have been named as licensee(s) of this document. This document is **non-transferrable, in whole or in part, to any and all third parties, including subsequent buyers, sellers, and listing agents.** Copying and pasting deficiencies to prepare the repair request is permitted. **THE INFORMATION IN THIS REPORT SHALL NOT BE RELIED UPON BY ANY ONE OTHER THAN THE CLIENT NAMED HEREIN.** This report is governed by an Inspection agreement that contained the scope of the inspection, including limitations, exclusions, and conditions of the copyright. **Unauthorized recipients are advised to contact a qualified Home Inspector of their choosing to provide them with their own Inspection and Report.**

Important Information / Limitations: Items Not Inspected and Other Limitations

ITEMS NOT INSPECTED - There are items that are not inspected in a home inspection such as, but not limited to; fences and gates, pools and spas, outbuildings or any other detached structure, washers / dryers, storm doors and storm windows, screens, window AC units, gas furnace heat exchangers, central vacuum systems, water softeners, alarm and intercom systems, and any item that is not a permanent attached component of the home. Also drop ceiling tiles are not removed, as they are easily damaged, and this is a non-invasive inspection. Subterranean systems are also excluded, such as but not limited to: sewer lines, septic tanks, water delivery systems, and underground fuel storage tanks.

Water and gas shut off valves are not operated under any circumstances. As well, any component or appliance that is unplugged or "shut off" is not turned on or connected for the sake of evaluation. We don't have knowledge of why a component may be shut down, and can't be liable for damages that may result from activating said components/appliances.

Also not reported on are the causes of the need for a repair; The methods, materials, and costs of corrections; Recalled appliances, items, and/or components; The suitability of the property for any specialized use; Compliance or non-compliance with codes, ordinances, statutes, regulatory requirements or restrictions; The market value of the property or its marketability; The advisability or inadvisability of purchase of the property; The insurability of the structure or any of its items or components; Any component or system that was not observed; Calculate the strength, adequacy, design, or efficiency of any system or component; Enter any area or perform any procedure that may damage the property or its components or be dangerous to the home inspector or other persons; Operate any system or component that is shut down or otherwise inoperable; Operate any system or component that does not respond to normal operating controls; Disturb insulation, move personal items, panels, furniture, equipment, plant life, soil, snow, ice, or debris that obstructs access or visibility. Also excluded is the proper installation of Stucco and EIFS and the repercussions of improper installation including water damage to the structure.

Lastly a home inspection does not address environmental concerns such as, but not limited to: Asbestos, lead, lead based paint, radon, mold, wood destroying insects or organisms (termites, etc), cockroaches, rodents, pesticides, fungus, treated lumber, Chinese drywall, mercury, or carbon monoxide.

Important Information / Limitations: Permits found

These are the permits that were found at the city or county site

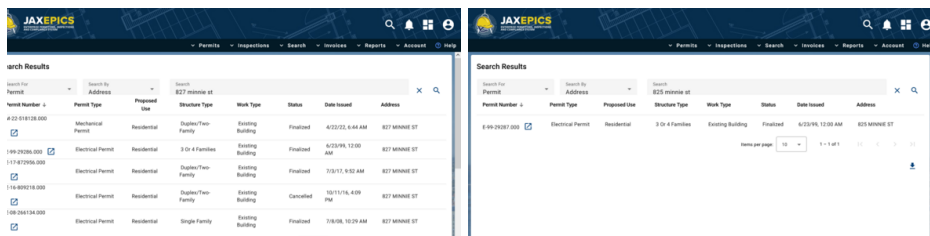

Important Information / Limitations: Recommended Contractors Information

CONTRACTORS / FURTHER EVALUATION: It is recommended that licensed professionals be used for repair issues or as it relates to the comments in this report, and copies of receipts are kept for warranty purposes. The use of the term "Qualified Person" in this report relates to an individual, company, or contractor whom is either licensed or certified in the field of concern. If we recommend evaluation or repairs by contractors or other licensed professionals, it is possible that they will discover additional problems since they will be invasive with their evaluation and repairs. Any listed items in this report concerning areas reserved for such experts should not be construed as a detailed, comprehensive, and/or exhaustive list of problems, or areas of concern.

CAUSES of DAMAGE / METHODS OF REPAIR: Any suggested causes of damage or defects, and methods of repair mentioned in this report are considered a professional courtesy to assist you in better understanding the condition of the home, and in our opinion only from the standpoint of

a visual inspection, and should not be wholly relied upon. Contractors or other licensed professionals will have the final determination on the causes of damage/deficiencies, and the best methods of repairs, due to being invasive with their evaluation. Their evaluation will supersede the information found in this report.

Important Information / Limitations: Thermal Imaging Information

THERMAL IMAGING: An infrared camera may be used for specific areas or visual problems, and should not be viewed as a full thermal scan of the entire home. Additional services are available at additional costs and would be supplemented by an additional agreement/addendum. Temperature readings displayed on thermal images in this report are included as a courtesy and should not be wholly relied upon as a home inspection is qualitative, not quantitative. These values can vary +/- 4% or more of displayed readings, and these values will display surface temperatures when air temperature readings would actually need to be conducted on some items which is beyond the scope of a home inspection. If a full thermal scan of the home is desired, please reach out to us to schedule this service for an additional fee.

Important Information / Limitations: Other Notes - Important Info

INACCESSIBLE AREAS: In the report, there may be specific references to areas and items that were inaccessible or only partly accessible. We can make no representations regarding conditions that may be present in these areas that were concealed or inaccessible for review. With access and an opportunity for inspection, **reportable conditions or hidden damage may be found in areas that were not accessible or only partly accessible and these conditions or damage is excluded from this inspection.**

QUALITATIVE vs QUANTITATIVE - A home inspection is not quantitative, when multiple or similar parts of a system, item, or component are found to have a deficiency, the deficiency will be noted in a qualitative manner such as "multiple present or one or more" etc. A quantitative number of deficient parts, pieces, or items will not be given as the repairing contractor will need to evaluate and ascertain the full amount or extent of the deficiency or damage. **This is not a technically exhaustive inspection.**

REPAIRS VERSUS UPGRADES - We inspect homes to today's safety and building standards. Therefore some recommendations made in this report may have not been required when the home was constructed. Building standards change and are improved for the safety and benefit of the occupants of the home and any repairs and/or upgrades mentioned should be considered for safety, performance, and the longevity of the homes items and components. **Although, we will address some recommended upgrades in the report, this should not be construed as a full listing of items that could potentially be upgraded.** To learn of **ALL** the ways the home could be brought up to today's building and safety standards, full and exhaustive evaluations should be conducted by qualified tradespeople.

COMPONENT LIFE EXPECTANCY - Components may be listed as having no deficiencies at the time of inspection, but may fail at any time due to their age or lack of maintenance, that couldn't be determined by the inspector.

PHOTOGRAPHS: Several photos are included in your inspection report as a courtesy and are not required by The State of FL Standards of Practice. These photos are for informational purposes only and do not attempt to show every instance or occurrence of a defect.

TYPOGRAPHICAL ERRORS: This report is proofread before sending it out, but typographical errors may be present. If any errors are noticed, please feel free to contact us for clarification.

Please acknowledge to us once you have completed reading this report. At that time we will be happy to answer any questions you may have, or provide clarification. Non-acknowledgement implies that you understood all information contained in this report.

Important Information / Limitations: Comment Key - Definitions

This report divides deficiencies into three categories; Significant/Major Defects (**in red**), Marginal Defects (**in orange**), and Minor Defects/Maintenance Items/FYI (**colored in blue**). Safety Hazards or Concerns will be listed in the **Red** or **Orange** categories depending on their perceived danger, but should always be addressed ASAP.

Significant Defects - Items or components that were not functional, represent a serious safety concern, and/or may require a major expense to correct. Items categorized in this manner require further evaluation and repairs or replacement as needed by a Qualified Contractor **prior to the end of your contingency period.**

Marginal Defects - Items or components that were found to include a safety hazard, or a functional or installation related deficiency. These items may have been functional at the time of inspection, but this functionality may be impaired, not ideal, and/or the defect may lead to further problems (most defects will fall into this categorization). Repairs or replacement is recommended to items categorized in this manner for optimal performance and/or to avoid future problems or adverse conditions that may occur due to the defect, **prior to the end of your contingency period.** Items categorized in this manner typically require repairs from a Handyman or Qualified Contractor **and are not considered routine maintenance or DIY repairs.**

Minor Defects/Maintenance Items/FYI - This categorization will include items or components that may need minor repairs that can improve their functionality, and/or items found to be in need of recurring or basic general maintenance. This categorization will also include FYI items that could include observations, important information, limitations, recommended upgrades to items, areas, or components, as well as items that were nearing, at, or past the end of their typical service life, but were in the opinion of the inspector, still functional at the time of inspection. Major repairs or replacement should be anticipated, and planned for, on any items that are designated as being past, or at the end of their typical life. These repairs or replacement costs can sometimes represent a major expense; i.e. HVAC systems, Water Heaters, Plumbing pipes, etc.

These categorizations are in my professional judgement and based on what I observed at the time of inspection. This categorization should not be construed as to mean that items designated as "**Minor defects**" or "**Marginal Defects**" do not need repairs or replacement. **The recommendations in each comment is more important than its categorization.** Due to your perception, opinions, or personal experience you may feel defects belong in a different category, and you should feel free to consider the importance you believe they hold during your purchasing decision. **Once again, it's the "Recommendations" in the text of the comment pertaining to each defect that is paramount, not its categorical placement.** **Neglecting attention, repairs, servicing, and/or maintenance can allow items designated as Blue to turn to Orange, Orange items to Red, etc.**

STANDARDS OF PRACTICE

Exterior

4.1 The inspector shall: A. inspect: 1. wall coverings, flashing, and trim. 2. exterior doors. 3. attached and adjacent decks, balconies, stoops, steps, porches, and their associated railings. 4. eaves, soffits, and fascias where accessible from the ground level. 5. vegetation, grading, surface drainage, and retaining walls that are likely to adversely affect the building. 6. adjacent and entryway walkways, patios, and driveways. B. describe wall coverings. 4.2 The inspector is NOT required to inspect: A. screening, shutters, awnings, and similar seasonal accessories. B. fences, boundary walls, and similar structures. C. geological and soil conditions. D. recreational facilities. E. outbuildings other than garages and carports. F. seawalls, break-walls, and docks. G. erosion control and earth stabilization measures.

Roof

In accordance with the Florida Standards of Practice the home inspector shall observe: The roof covering, roof drainage systems, visible flashings, skylights, chimneys, and roof penetrations; and report on signs of leaks or abnormal condensation on building components. **The home inspector shall:** Describe the type of roof covering materials, and Report on the method used to observe the roofing.

The home inspector is not required to: Walk on the roofing (although every safe attempt to do so, will be taken), report on the age or remaining life of the roof covering, move leaves, snow, or other items on the surface that may block visual accessibility, or observe attached accessories including but not limited to solar systems, antennae, satellite dishes and lightning arrestors. No claims will be made as to remaining roof material life expectancy, and no guarantee or warranty should be expected from comments or observations. The sellers or the occupants of a residence will generally have the most relevant knowledge of the roof and of its history. Therefore, I recommend that you consult with the sellers about the age of the roof covering, and that you either include comprehensive roof coverage in your home insurance policy, or that you obtain a roof certification from an established local roofing company.

Water Heater

In accordance with the State of Florida Standards of Practice the inspector will examine and report the condition: of the water heater enclosure, plumbing supply, energy source, venting, and TPR valve, if applicable. The inspector is not required to: activate the system if it is powered down, or the pilot flame is not lit, Inspect the system for proper sizing, design, or use of proper materials.

Interior Areas

In accordance with the Florida Standards of Practice **the home inspector shall observe:** walls, ceilings, and floors; steps, stairways, balconies, and railings; counters and a representative number of installed cabinets; and a representative number of doors and windows; fireplaces by examining the firebox, operating the damper, and reporting on the presence of a gas shut off valve. **The home inspector shall:** Operate a representative number of receptacles, switches, windows, and interior doors; and report on signs of abnormal or harmful water penetration into the building or signs of abnormal or harmful condensation on building components.

The home inspector is not required to observe: Paint, wallpaper, and other finish treatments on the interior walls, ceilings, and floors; Carpeting, tile; or Draperies, blinds, or other window treatments. Gas fireplaces are not tested for functionality, and the pilot light will not be lit if it's off at the time of inspection. An evaluation by a gas company is recommended before using any gas appliances in the home.

Electrical

In accordance with the State of Florida Standards of Practice **the home inspector shall observe:** Service entrance conductors; Service equipment, grounding equipment, the main over current device, and main and distribution panels; Amperage and voltage ratings of the service (if the conductors' sizing text is present / legible); Branch circuit conductors, their over current devices, and the compatibility of their ampacities and voltages. **The home inspector shall describe:** Service amperage and voltage (if known); Service entry conductor materials; Service type as being overhead or underground; and the location of main and distribution panels. **The home inspector shall report on:** the presence of any observed aluminum branch circuit wiring.

The home inspector is not required to: Insert any tool, probe, or testing device inside the panels; Test or operate any over current device except ground fault circuit interrupters; Dismantle any electrical device or control other than to remove the covers of the main and auxiliary distribution panels; or Observe: Motion or Dusk to Dawn lighting, Low voltage systems; Security system devices, heat detectors, or carbon monoxide detectors; Telephone, security, cable TV, intercoms, or other ancillary wiring that is not a part of the primary electrical distribution system.

Heating, Cooling

In accordance with the State of Florida Standards of Practice **the home inspector shall observe:** the permanently installed heating and cooling systems including: Heating and cooling equipment that is central to the home; visible ducts and piping, air filters, registers, and the presence of an installed heating and cooling source in each room. **The home inspector shall describe:** the energy source and heating equipment. The home inspector shall operate the systems using normal operating controls. The home inspector shall open readily accessible access panels provided by the manufacturer or installer for routine homeowner maintenance. **The home inspector is not required to:** Operate heating systems when weather conditions or other circumstances may cause equipment damage; Operate automatic safety controls; Ignite or extinguish solid fuel fires; or Observe: Humidifiers; Electronic air filters; or The uniformity or adequacy of heat supply to the various rooms. Efficiency of the units and load testing are not conducted. Air conditioning units can not be tested when temperatures are lower than 60 degrees, due to the possibility of damaging the compressor. Clients are advised to have an HVAC company to perform maintenance on the system on an annual basis.

Kitchen

In accordance with the Florida Standards of Practice the inspector will examine and report on the condition and operation of the dishwasher by initiating a cycle, the range by testing heating elements and the oven, the mounted microwave by starting a warm-up cycle, test the hot/cold water supply at the fixture, look for leaks in the plumbing and fixtures/faucet, examine counters, walls, ceilings, floors, a representative number of cabinets, windows, doors, and the presence of GFCI receptacles and their operation, if applicable. Homes built prior to 1987 were not required to have GFCI receptacles in the kitchen, but upgrading is recommended for safety.

The home inspector is not required to report on: Clocks, timers, self-cleaning oven functions, or thermostats for calibration or automatic operation; Non built-in appliances; or Refrigeration units. **The home inspector is not required to operate:** Appliances in use; or Any appliance that is shut down or otherwise inoperable.

Bathroom(s)

In accordance with the Florida Standards of Practice the inspector will examine and report the condition of the: sinks, showers, tubs, enclosures, toilets, exposed plumbing, presence of leaks from plumbing, fixtures, and/or faucets. As well as the walls, floors, ceilings, a representative number of windows and doors, heating/cooling source, ventilation, and presence of GFCI protection, if applicable. GFCI protection in bathrooms was not required in homes built prior to 1975; but upgrading is recommended for safety.

The home inspector is not required to: Operate any valve except water closet flush valves, fixture faucets, and hose faucets; or Inspect the system for proper sizing, design, or use of proper materials.

Plumbing

In accordance with industry standards **the home inspector shall observe at visible portions:** Interior water supply and distribution system, including: piping materials and supports; fixtures and faucets; functional flow; leaks; and cross connections. Interior drain, waste, and vent system, including: traps; drain and waste lines; leaks; and functional drainage. **The home inspector shall describe:** Water supply and distribution piping materials; Drain, waste, and vent piping materials; and Location of the main water supply shutoff device. The home inspector shall operate all plumbing fixtures, including their faucets and all exterior faucets attached to the house, except where the flow end of the faucet is connected to an appliance.

The home inspector is not required to: State the effectiveness of anti-siphon devices; Determine whether water supply and waste disposal systems are public or private; Operate automatic safety controls; Operate any valve except water closet flush valves, fixture faucets, and hose faucets; Observe: Water conditioning systems; Fire and lawn sprinkler systems; On-site water supply quantity and quality; On-site waste disposal systems; Foundation irrigation systems; Spas, except as to functional flow and functional drainage; Swimming pools; Solar water heating equipment; or Observe the system for proper sizing, design, or use of proper materials.

Attic, Roof Structure, & Ventilation

In accordance with the State of Florida Standards of Practice **the inspector will examine:** the attic area and report on the condition of the access opening (including location), insulation type (and current depth), ducts, visible electrical components, exhaust terminations, plumbing components, and ventilation if applicable.

The inspector is not required to: move or disturb insulation, or report on the adequacy of current ventilation, Calculate the strength, adequacy, or efficiency of any system or component including framing. Enter any attic that may damage the property or its components or be dangerous to or adversely affect the health or safety of the home inspector or other persons. Therefore, I do not attempt to enter attics with less than 36" of headroom; where insulation obscures the ceiling joists; or where ducts block access. In these cases I will evaluate from the access opening as best I can.

Structural Components

The Home Inspector shall observe structural components including foundations, floors, walls, columns or piers, ceilings and roof. The home inspector shall describe the type of Foundation, floor structure, wall structure, columns or piers, ceiling structure, roof structure. The home inspector shall: Probe structural components where deterioration is suspected; Enter under floor crawl spaces, basements, and attic spaces except when access is obstructed, when entry could damage the property, or when dangerous or adverse situations are suspected; Report the methods used to observe under floor crawl spaces and attics; and Report signs of abnormal or harmful water penetration into the building or signs of abnormal or harmful condensation on building components. The home inspector is not required to: Enter any area or perform any procedure that may damage the property or its components or be dangerous to or adversely effect the health of the home inspector or other persons or that is not readily accessible. Move stored items or debris. Operate a sump pump with inaccessible floats. Identify the size, spacing, span or location or determine the adequacy of foundation bolting, bracing, joists, joist spans or support systems. Provide any engineering or architectural service. While the inspector may report some of these items, it should not be expected and is outside the scope of a Home Inspection. The structural components were inspected and reported on with the information, comments and recommendations in this section. While the inspector makes every effort to find all areas of concern, some areas can go unnoticed. Please be aware that the inspector has your best interest in mind. Any repair items mentioned in this report should be considered before purchase. It is recommended that qualified contractors be used in your further inspection or repair issues as it relates to the comments in this inspection report.