

33.120 Multi-Dwelling Zones

120

Sections:

General

- 33.120.010 Purpose
- 33.120.020 List of the Multi-Dwelling Zones
- 33.120.030 Characteristics of the Zones
- 33.120.040 Other Zoning Regulations
- 33.120.050 Neighborhood Contact

Use Regulations

- 33.120.100 Primary Uses

Development Standards

- 33.120.200 Housing Types Allowed
- 33.120.205 Development on Lots and Lots of Record
- 33.120.206 Minimum Required Site Frontage for Development
- 33.120.210 Floor Area Ratio
- 33.120.211 Floor Area Bonus Options
- 33.120.212 Maximum Density
- 33.120.213 Minimum Density
- 33.120.215 Height
- 33.120.220 Setbacks
- 33.120.225 Building Coverage
- 33.120.230 Building Length and Façade Articulation
- 33.120.231 Main Entrances
- 33.120.232 Street-Facing Facades
- 33.120.235 Landscaped Areas
- 33.120.237 Trees
- 33.120.240 Required Outdoor and Common Areas
- 33.120.250 Screening
- 33.120.255 Pedestrian Standards
- 33.120.260 Recycling Areas
- 33.120.270 Alternative Development Options
- 33.120.275 Development Standards for Institutions
- 33.120.280 Detached Accessory Structures
- 33.120.283 Additional Development Standards for Structured Parking and Garages
- 33.120.284 Additional Development Standards for Flag Lots
- 33.120.285 Fences
- 33.120.290 Demolitions
- 33.120.300 Nonconforming Development
- 33.120.305 Parking and Loading
- 33.120.310 Signs
- 33.120.320 Inclusionary Housing
- 33.120.330 Street and Pedestrian Connections

Supplemental Information

- Map 120-1 Civic and Neighborhood Corridors
- Map 120-2 Minimum Required Site Frontage Areas
- Map 120-3 Pattern Areas

General

33.120.010 Purpose

The multi-dwelling zones are intended to preserve land for urban housing and to provide opportunities for multi-dwelling housing.

- A. Use regulations.** The use regulations are intended to create and maintain higher density residential neighborhoods. At the same time, they allow for institutional, limited commercial, and other nonresidential uses, but not to such an extent as to sacrifice the overall residential neighborhood character of the multi-dwelling zones and their intended role as places for housing.
- B. Development standards.** The six multi-dwelling zones are distinguished primarily by their allowed scale and development standards. The development standards work together to create desirable residential areas by promoting aesthetically pleasing environments, safety, privacy, energy conservation, and recreational opportunities. The development standards generally assure that new development will be compatible with the City’s character and contribute to the intended characteristics of each zone. At the same time, the standards allow for flexibility for new development. In addition, the regulations provide certainty to property owners, developers, and neighbors about the limits of what is allowed. The development standards are generally written for development on flat, regularly shaped lots. Other situations are addressed through special standards or exceptions.

33.120.020 List of the Multi-Dwelling Zones

The full and short names of the multi-dwelling residential zones and their map symbols are listed below. When this Title refers to the multi-dwelling zones, it is referring to the six zones listed here. When this Title refers to the residential zones or R zones, it is referring to both the single-dwelling zones in Chapter 33.110 and the multi-dwelling zones in this chapter.

Full Name	Short Name/Map Symbol
Residential Multi-Dwelling 1	RM1
Residential Multi-Dwelling 2	RM2
Residential Multi-Dwelling 3	RM3
Residential Multi-Dwelling 4	RM4
Central Residential	RX
Residential Manufactured Dwelling Park	RMP

33.120.030 Characteristics Of The Zones

- A. RM1 zone.** The RM1 zone is a low-scale multi-dwelling zone that is generally applied in locations intended to provide a transition in scale to single-dwelling residential areas, such as the edges of mixed-use centers and civic corridors, and along or near neighborhood corridors. Allowed housing is characterized by one to three story buildings that relate to the patterns of residential neighborhoods, but at a somewhat larger scale and building coverage than allowed in the single-dwelling zones. The major types of new development

will be duplexes, triplexes, rowhouses, courtyard housing, small apartment buildings, and other relatively small-scale multi-dwelling and small-lot housing types that are compatible with the characteristics of Portland's residential neighborhoods.

- B. RM2 zone.** The RM2 zone is a medium-scale multi-dwelling zone that is generally applied in and around a variety of centers and corridors that are well-served by transit. Allowed housing is characterized by buildings of up to three or four stories with a higher percentage of building coverage than in the RM1 zone, while still providing opportunities for landscaping and outdoor spaces that integrate with residential neighborhood characteristics. The major types of new housing development will be a diverse range of multi-dwelling structures and other compact housing that contribute to the intended urban scale of centers and corridors, while providing transitions in scale and characteristics to lower-scale residential neighborhoods.
- C. RM3 zone.** The RM3 zone is a medium to high density multi-dwelling zone applied near the Central City, and in centers, station areas, and along civic corridors that are served by frequent transit and are close to commercial services. It is intended for compact, urban development with a high percentage of building coverage and a strong building orientation to the pedestrian environment of streets. This zone is intended for areas where the established residential character includes landscaped front setbacks. Allowed housing is characterized by mid-rise buildings up to six stories tall. The Design overlay zone is applied to this zone.
- D. RM4 zone.** The RM4 zone is a high density, urban-scale multi-dwelling zone applied near the Central City, and in town centers, station areas, and along civic corridors that are served by frequent transit and are close to commercial services. It is intended to be an intensely urban zone with a high percentage of building coverage and a strong building orientation to the pedestrian environment of streets, with buildings located close to sidewalks with little or no front setback. This is a mid-rise to high-rise zone with buildings of up to seven or more stories. The Design overlay zone is applied to this zone.
- E. RX zone.** The RX zone is a high density multi-dwelling zone that allows the greatest intensity of development scale in the residential zones. The zone is applied within Portland's most intensely urban areas, specifically the Central City and the Gateway Regional Center. Allowed housing development is characterized by large buildings with a very high percentage of building coverage. The major types of new housing development will be mid-rise and high-rise multi-dwelling structures, often with allowed retail, institutional, or other service oriented uses. Development is intended to be pedestrian-oriented, with buildings that contribute to an urban environment with a strong street edge of buildings located close to sidewalks. The Design overlay zone is applied to this zone.
- F. RMP zone.** The RMP zone is a low-scale multi-dwelling zone that allows manufactured dwelling parks. Allowed density may be up to 29 units per acre. Allowed housing is manufactured dwellings that are assembled off-site. Units are generally surrounded by vehicle circulation systems, pedestrian pathways and open area, often resulting in lower building coverage than other multi-dwelling zones. Development is compatible with low- and medium-density single-dwelling development and multi-dwelling development. Generally, RMP zoning will be applied on large sites.

33.120.040 Other Zoning Regulations

The regulations in this chapter state the allowed uses and development standards for the base zones. Sites with overlay zones, plan districts, or designated historical landmarks are subject to additional regulations. The Official Zoning Maps indicate which sites are subject to these additional regulations. Specific uses or development types may also be subject to regulations in the 200s series of chapters.

33.120.050 Neighborhood Contact

Neighborhood contact is a set of outreach steps that must be taken before certain developments can be submitted for approval. Neighborhood contact is required as follows:

A. Neighborhood contact I.

1. Neighborhood contact I requirements. When proposed development will add at least 10,000 square feet and not more than 25,000 square feet of net building area to a site, the neighborhood contact steps of 33.705.020.A., Neighborhood contact I, are required. All the steps in 33.705.020.A. must be completed before an application for a building permit can be submitted.
2. Exemption. If the proposed development has already met the neighborhood contact requirements as part of a land use review process, it is exempt from the neighborhood contact requirements.

B. Neighborhood contact II.

1. Neighborhood contact II requirements. When the proposed development will add more than 25,000 square feet of net building area to a site, the neighborhood contact steps of 33.705.020.B., Neighborhood contact II, are required. All of the steps in 33.705.020.B. must be completed before an application for a building permit can be submitted.
2. Exemption. If the proposed development has already met the neighborhood contact requirements as part of a land use review process, it is exempt from the neighborhood contact requirements.

Use Regulations

33.120.100 Primary Uses

- A. Allowed uses.** Uses allowed in the multi-dwelling zones are listed in Table 120-1 with a "Y". These uses are allowed if they comply with the development standards and other regulations of this Title. Being listed as an allowed use does not mean that a proposed use will be granted an adjustment or other exception to the regulations of this Title. In addition, a use or development listed in the 200s series of chapters is also subject to the regulations of those chapters.
- B. Limited uses.** Uses allowed in these zones subject to limitations are listed in Table 120-1 with an "L". These uses are allowed if they comply with the limitations listed below and the development standards and other regulations of this Title. In addition, a use or development listed in the 200s series of chapters is also subject to the regulations of those

chapters. The paragraphs listed below contain the limitations and correspond with the footnote numbers from Table 120-1.

1. Retail Sales And Service and Office uses. This regulation applies to all parts of Table 120-1 that have a [1].
 - a. Limited uses. Retail Sales And Service and Office uses are allowed when:
 - (1) Retail Sales And Service and Office use on Civic and Neighborhood corridors. Retail Sales And Service and Office uses are allowed, up to the following amounts, on sites that abut a Civic or Neighborhood corridor shown on Map 120-1. All of the Retail Sales And Service and Office uses allowed by this Subsubparagraph must be located on the ground floor within 100 feet of the street lot line adjacent to the Civic or Neighborhood corridor and there can be no exterior activities associated with the use except for outdoor seating:
 - In the RM1 and RM2 zones, each use allowed by this Subsubparagraph is limited to 1,000 square feet of net building area up to a total combined floor area ratio of .25 to 1 for all of the uses allowed by this Subsubparagraph. More than .25 to 1 total on the site and more than 1,000 square feet per use is prohibited; and
 - In the RM3, RM4, and RX zones, each use allowed by this Subsubparagraph is limited to 2,000 square feet of net building area up to a total combined floor area ratio of .4 to 1 for all of the uses allowed by this Subsubparagraph. More than .4 to 1 total on the site and more than 2,000 square feet per use is prohibited;
 - (2) Retail Sales And Service and Office use in the RM3 and RM4 zones. Retail Sales and Service and Office uses are allowed in multi-dwelling buildings in the RM3 and RM4 zones. Each use allowed by this Subsubparagraph is limited to 1,000 square of net building area up to a total combined floor to area ratio of .1 to 1 for all of the uses allowed by this Subsubparagraph. More than .1 to 1 total on the site and more than 1,000 square feet per use is prohibited. The uses allowed by this Subsubparagraph must be located entirely within the building and must have no external doors or signs visible from the exterior of the building. Development of a use allowed by this Subsubparagraph must not result in reduction of existing dwelling units.
 - b. Conditional uses. Retail plant nurseries that do not meet the standards of Subparagraph B.1.a. are a conditional use.
2. Commercial Parking in RX. This regulation applies to all parts of Table 120-1 that have a [2]. Outside the Central City plan district, Commercial Parking facilities in parking structures are a conditional use. Commercial Parking facilities in surface lots are prohibited. Within the Central City plan district, there are special regulations; see Chapter 33.510. Any ground floor retail requirements that result from other regulations continue to apply and are reviewed as part of the land use review process.
3. Community Service and Schools in RX. This regulation applies to all parts of Table 120-1 that have a [3]. Most Community Service uses are regulated by Chapter 33.815,

Conditional Uses. Short term, mass, and outdoor shelters are regulated by Chapter 33.285, Short Term, Mass, and Outdoor Shelters.

- a. Limited uses. Community Service and Schools uses are allowed in a multi-dwelling development if all of the Community Service and Schools uses are located on the ground floor. If any portion of a Community Service or Schools use is not on the ground floor of a multi-dwelling development, the Community Services and Schools uses are limited to 20 percent of the net building area;
 - b. Conditional uses. If any portion of the Community Service and Schools uses is not on the ground floor of a multi-dwelling development and the uses exceed 20 percent of the total net building area, then a conditional use review is required.
4. Community Service in RM1 through RM4 and RMP. This regulation applies to all parts of Table 120-1 that have a [4]. Most Community Service uses are regulated by Chapter 33.815, Conditional Uses. Short term, mass, and outdoor shelters are regulated by Chapter 33.285, Short Term, Mass, and Outdoor Shelters.
5. Parks And Open Areas. This regulation applies to all parts of Table 120-1 that have a [5]. Parks And Open Areas uses are allowed by right. However, certain accessory uses and facilities which are part of a Parks And Open Areas use require a conditional use review. These accessory uses and facilities are listed below.
- a. Swimming pools.
 - b. Cemeteries, including mausoleums, chapels, and similar accessory structures associated with funerals or burial.
 - c. Golf courses, including club houses, restaurants, and driving ranges.
 - d. Boat ramps.
 - e. Parking areas.
 - f. Recreational fields for organized sports. Recreational fields used for organized sports are subject to the regulations of Chapter 33.279, Recreational Fields for Organized Sports.
6. Daycare. This regulation applies to all parts of Table 120-1 that have a [6]. Daycare uses are allowed as follows:
- a. Allowed use. Daycare uses are allowed by right if located in within a building that currently contains or did contain a College, Medical Center, School, Religious Institution, or a Community Service use.
 - b. Limited use. Daycare uses are allowed when:
 - (1) The total amount of Daycare use on the site does not exceed 3,000 square feet of net building area. The total amount allowed does not include outdoor play area; and
 - (2) All of the Daycare use, except for outdoor play area, is located on the ground floor.

- c. Conditional uses. Daycare uses that do not meet Subparagraph B.6.a. or b. are a conditional use.
7. Radio Frequency Transmission Facilities. This regulation applies to all parts of Table 120-1 that have a [7]. Some Radio Frequency Transmission Facilities are allowed by right. See Chapter 33.274.
8. Basic Utilities. These regulations apply to all parts of Table 120-1 that have a [8].
 - a. Basic Utilities that serve a development site are accessory uses to the primary use being served;
 - b. Small Scale Energy Production that provides energy for on-site or off-site use are considered accessory to the primary use on the site. Installations that sell power they generate—at retail (net metered) or wholesale—are included. However, they are only considered accessory if they generate energy from biological materials or byproducts from the site itself, or conditions on the site itself; materials from other sites may not be used to generate energy. In the RX zone, up to 10 tons per week of biological materials or byproducts from other sites may be used to generate energy. The requirements of Chapter 33.262 Off Site Impacts must be met;
 - c. All other Basic Utilities are a conditional use except in the RX zone where all other Basic Utilities are allowed but are limited to 20 percent of the net building area on a site. If they are over 20 percent of the net building area, a conditional use review is required.
9. Agriculture. This regulation applies to all parts of Table 120-1 that have a [9]. If the use and site do not meet the regulations of Chapter 33.237, Food Production and Distribution, it is prohibited.
10. Retail Sales and Service in the RMP zone. This regulation applies to all parts of Table 120-1 that have note [10]. Recreational vehicle parks are allowed by right in the RMP zone. All other Retail Sales And Service uses are prohibited.

C. Conditional uses.

1. Table 120-1. Uses which are allowed if approved through the conditional use review process are listed in Table 120-1 with a “CU”. These uses are allowed provided they comply with the conditional use approval criteria for that use, the development standards, and other regulations of this Title. Uses listed with a “CU” that also have a footnote number in the table are subject to the regulations cited in the footnote. In addition, a use or development listed in the 200s series of chapters is also subject to the regulations of those chapters. The conditional use review process and approval criteria are stated in Chapter 33.815, Conditional Uses.
2. Accessory short-term rentals. Accessory short-term rentals are accessory uses that may require a conditional use review. See Chapter 33.207.

D. Prohibited uses. Uses listed in Table 120-1 with an “N” are prohibited. Existing uses in categories listed as prohibited may be subject to the regulations of Chapter 33.258, Nonconforming Uses And Development.

Table 120-1 Multi-Dwelling Zone Primary Uses						
Use Categories	RM1	RM2	RM3	RM4	RX	RMP
Residential Categories						
Household Living	Y	Y	Y	Y	Y	Y
Group Living	Y	Y	Y	Y	Y	N
Commercial Categories						
Retail Sales And Service	L [1]	L [1]	L [1]	L [1]	L [1]	L [10]
Office	L [1]	L [1]	L [1]	L [1]	L [1]	N
Quick Vehicle Servicing	N	N	N	N	N	N
Vehicle Repair	N	N	N	N	N	N
Commercial Parking	N	N	N	N	CU [2]	N
Self-Service Storage	N	N	N	N	N	N
Commercial Outdoor Recreation	N	N	N	N	N	N
Major Event Entertainment	N	N	N	N	N	N
Industrial Categories						
Manufacturing And Production	N	N	N	N	N	N
Warehouse And Freight Movement	N	N	N	N	N	N
Wholesale Sales	N	N	N	N	N	N
Industrial Service	N	N	N	N	N	N
Bulk Fossil Fuel Terminal	N	N	N	N	N	N
Railroad Yards	N	N	N	N	N	N
Waste-Related	N	N	N	N	N	N
Institutional Categories						
Basic Utilities	L/CU [8]	L/CU [8]	L/CU [8]	L/CU [8]	L/CU [8]	L/CU [8]
Community Service	L/CU [4]	L/CU [4]	L/CU [4]	L/CU [4]	L/CU [3]	L/CU [4]
Parks And Open Areas	L/CU [5]	L/CU [5]	Y	Y	Y	L/CU [5]
Schools	CU	CU	CU	CU	L/CU [3]	CU
Colleges	CU	CU	CU	CU	CU	CU
Medical Centers	CU	CU	CU	CU	CU	CU
Religious Institutions	CU	CU	CU	CU	CU	CU
Daycare	L/CU [6]	L/CU [6]	L/CU [6]	L/CU [6]	Y	L/CU [6]

Table 120-1 Multi-Dwelling Zone Primary Uses						
Use Categories	RM1	RM2	RM3	RM4	RX	RMP
Other Categories						
Agriculture	L [9]	L [9]	L [9]	L [9]	L [9]	L [9]
Aviation And Surface Passenger Terminals	N	N	N	N	N	N
Detention Facilities	N	N	N	N	N	N
Mining	N	N	N	N	N	N
Radio Frequency Transmission Facilities	L/CU [7]	L/CU [7]	L/CU [7]	L/CU [7]	L/CU [7]	L/CU [7]
Rail Lines And Utility Corridors	CU	CU	CU	CU	CU	CU

Y = Yes, Allowed

L = Allowed, But Special Limitations

CU = Conditional Use Review Required

N = No, Prohibited

Notes:

- The use categories are described in Chapter 33.920.
- Regulations that correspond to the bracketed numbers [] are stated in 33.120.100.B.
- Specific uses and developments may also be subject to regulations in the 200s series of chapters.

Development Standards

33.120.200 Housing Types Allowed

- A. Purpose.** A broad range of housing types are allowed in the multi-dwelling zones. This range allows for efficient use of land, provides options to increase housing variety and housing opportunities, and promotes affordable and energy-efficient housing.
- B. Housing types.** The types of housing allowed in the multi-dwelling zones are stated in Table 120-2.

Housing Type	RM1	RM2	RM3	RM4	RX	RMP
House	Yes	Yes	Yes	Yes	Yes	No
Attached House (See 33.120.270 C.)	Yes	Yes	Yes	Yes	Yes	No
Accessory dwelling unit (See 33.205)	Yes	Yes	Yes	Yes	Yes	No
Duplex	Yes	Yes	Yes	Yes	Yes	No
Attached Duplex (See 33.120.270.F)	Yes	Yes	Yes	Yes	Yes	No
Triplex	Yes	Yes	Yes	Yes	Yes	No
Fourplex	Yes	Yes	Yes	Yes	Yes	No
Multi-Dwelling Structure	Yes	Yes	Yes	Yes	Yes	No
Multi-Dwelling Development	Yes	Yes	Yes	Yes	Yes	Yes [1]
Manufactured Dwelling (See Chapter 33.251)	Yes	Yes	Yes	Yes	Yes	Yes [2]
Manufactured Dwelling Park (See Chapter 33.251)	Yes	No	No	No	No	Yes
Houseboat (See Chapter 33.236)	Yes	Yes	Yes	Yes	Yes	No
Congregate Housing Facility	Yes	Yes	Yes	Yes	Yes	No

Yes = allowed; No = prohibited.

Notes:

[1] The only type of multi-dwelling development allowed in the RMP zone is manufactured dwellings in a manufactured dwelling park.

[2] Except on individual lots created under the provisions of 33.642, Land Divisions of Manufactured Dwelling Parks, manufactured dwellings are only allowed in manufactured dwelling parks.

33.120.205 Development on Lots and Lots of Record

- A. Purpose.** The regulations of this section require lots and lots of record to be an adequate size so that development on a site will in most cases be able to comply with all site development standards, including density. Where more than one lot is in the same ownership, these standards prevent breaking up large vacant ownerships into small lots, which are difficult to develop in conformance with the development standards. However, where more than one lot is in the same ownership, and there is existing development, allowing the ownership to be separated may increase opportunities for residential infill while preserving existing housing.
- B. Where these regulations apply.** These regulations apply to existing lots and lots of record in the multi-dwelling zones. The creation of new lots is subject to the lot size standards listed in Chapter 33.612, Lots in Multi-Dwelling Zones.
- C. Ownership of multiple lots and lots of record.** Where more than one abutting lot or lot of record is in the same ownership, the ownership may be separated as follows:
 - 1. If all requirements of this Title will be met after the separation, including lot dimensions, minimum density, and parking, the ownership may be separated; or

2. If one or more of the lots or lots of record does not meet the lot dimension standards in Chapter 33.612, Lots in Multi-Dwelling Zones, the ownership may be separated if all requirements of this paragraph are met. Such lots and lots of record are legal.
 - a. There is a primary use on at least one of the lots or lots of record, and the use has existed since December 31, 1980. If none of the lots or lots of record have a primary use, they may not be separated; and
 - b. Lots or lots of record with a primary use on at least one of them may be separated as follows:
 - (1) The separation must occur along the original lot lines;
 - (2) Lots or lots of record with primary uses on them may be separated from lots or lots of record with other primary uses; and
 - (3) Lots or lots of record with primary uses on them may be separated from lots or lots of record without primary uses.
- D. New development on standard lots and lots of record.** New development on lots and lots of record that comply with the lot dimension standards in Chapter 33.612, Lots in Multi-Dwelling Zones, is allowed by right subject to the development standards.
- E. New development on substandard lots and lots of record.** New development is allowed on lots and lots of record which do not conform to the lot dimension standards in Chapter 33.612, Lots in Multi-Dwelling Zones, if both of the following are met:
 1. The development is proposed for a lot or lot of record. Development on plots that are not lots or lots of record is prohibited; and
 2. The lot or lot of record did not abut any property owned by the same family or business on July 26, 1979, or any time since that date, unless the ownership was separated as allowed in Subsection C, above.

33.120.206 Minimum Required Site Frontage for Development

- A. Purpose.** The purpose of the minimum required site frontage standard is to ensure that sites in and around certain centers in Eastern Portland have sufficient street frontage and site area to:
 - Accommodate new streets where pedestrian, bicycle and vehicular connectivity is lacking;
 - Foster efficient site design;
 - Allow for buildings with an orientation to the street; and
 - Provide opportunities to create outdoor space and preserve trees.
- B. Where the standard applies.** The minimum required site frontage standard applies in the multi-dwelling zones to sites shown on Map 120-2.
- C. Minimum required site frontage standard.**
 1. Standard. If the site is more than 160 feet deep, new dwelling units are prohibited unless the site has at least 90 feet of frontage on a street. Adjustments are prohibited.

2. Exceptions. The following exceptions apply:
- a. Adding an accessory dwelling unit to a lot with an existing house, existing attached house, existing manufactured home, or existing duplex is allowed;
 - b. Development is allowed on a site when all of the lots that share a side lot line with the development site meets at least one of the following:
 - (1) The lot is zoned multi-dwelling and meets the minimum density standard for the base zone;
 - (2) The lot is zoned multi-dwelling and has an existing multi-dwelling structure or multi-dwelling development; or
 - (3) The lot is not zoned multi-dwelling; and
 - c. Development approved through a Planned Development Review is allowed. See Chapter 33.270, Planned Development.

**Table 120-3
Summary of Development Standards in Multi-Dwelling Zones**

Standard	RM1	RM2	RM3	RM4	RX	RMP
Maximum FAR (See 33.120.210)	FAR of 1 to 1	FAR of 1.5 to 1	FAR of 2 to 1	FAR of 4 to 1 or 3 to 1	FAR of 4 to 1	NA
Maximum Density (See 33.120.212)	none	none	none	none	none	1 unit per 1,500 sq. ft. of site area
Maximum Density with Affordable Housing Bonus (See 33.120.212.C)	NA	NA	NA	NA	NA	1 unit per 1,000 sq. ft. of site area
Minimum Density (See 33.120.213)	1 unit per 2,500 sq. ft. of site area	1 unit per 1,450 sq. ft. of site area	1 unit per 1,000 sq. ft. of site area	1 unit per 1,000 sq. ft. of site area	1 unit per 500 sq. ft. of site area	1 unit per 1,875 sq. ft. of site area
Base Height (See 33.120.215)	35 ft.	45 ft.	65 ft.	75/100 ft.	100 ft.	35 ft.

**Table 120-3
Summary of Development Standards in Multi-Dwelling Zones**

Standard	RM1	RM2	RM3	RM4	RX	RMP
Step-down Height (see 33.120.215.B.2 - Within 25 ft. of lot line abutting RF-R2.5 zones - Within 15 ft. of lot line across a local service street from RF – R2.5 Zones	35 ft. 35 ft.	35 ft. 45 ft.	35 ft. 45 ft.	35 ft. 45 ft.	35 ft. 45 ft.	35 ft. 35 ft.
Minimum Setbacks - Front building setback - Side and rear building setback. - Garage entrance setback (See 33.120.220)	10 ft. 5 ft. [1] 18 ft.	10 ft. 5 ft. [1] 5/18 ft.	10 ft. 5/10 ft. [1] 5/18 ft.	5 ft. 5/10 ft. [1] 5/18 ft.	0 ft. 0 ft. 5/18 ft.	10 ft. 10 ft. 18 ft.
Maximum Setbacks (See 33.120.220) Transit Street or Pedestrian District	20 ft.	20 ft.	20 ft.	10 ft.	10 ft.	NA
Max. Building Coverage (See 33.120.225)	50% of site area	60/70% of site area	85% of site area	85% of site area	100% of site area	50% of site area
Max. Building Length (See 33.120.230)	Yes	Yes	No	No	No	Yes
Min. Landscaped Area (See 33.120.235)	30% of site area	20% of site area	15% of site area	15% of site area	none	30% of site area
Required Outdoor Areas (See 33.120.240)	Yes	Yes	Yes	Yes	No	See 33.251

Notes:

[1] See 33.120.220.B.2 for Eastern Pattern Area special rear building setback.

33.120.210 Floor Area Ratio

- A. Purpose.** Floor area ratios (FARs) regulate the amount of use (the intensity) allowed on a site. FARs provide a means to match the potential amount of uses with the desired character of the area and the provision of public services. FARs also work with the height, setback, and building coverage standards to control the overall bulk of development.
- B. FAR standard.** The maximum floor area ratios are stated in Table 120-3 and apply to all uses and development. In the RM4 zone the maximum FAR is 4 to 1, except in Historic Districts and Conservation Districts, where the maximum FAR is 3 to 1. Floor area ratio is not applicable in the RMP zone. There is no maximum limit on the number of dwelling units within the allowable floor area, but the units must comply with all building and housing

code requirements. Additional floor area may be allowed through bonus options described in Section 33.120.211, or transferred as described in Subsection D. Maximum FAR does not apply to one alteration or addition of up to 250 square feet when the alteration or addition is to a primary structure that received final inspection at least 5 years ago. This exception is allowed once every 5 years. Adjustments to the maximum floor area ratios are prohibited. Floor area does not include the following:

1. Floor area for structured parking and required long-term bicycle parking not located in a dwelling unit, up to a maximum FAR of 0.5 to 1; and
 2. Floor area for indoor common area used to meet the requirements of Section 33.120.240.
- C. Maximum increase in FAR.** An increase in FAR using bonuses and transfers of more than is stated in Table 120-5 is prohibited. This total FAR includes FAR transferred from another site, and any additional FAR allowed from bonus options.
- D. Transfer of FAR.** FAR may be transferred from one site to another subject to the following:
1. Sending site. FAR may be transferred from:
 - a. A site where all existing dwelling units are affordable to those earning no more than 60 percent of the area median family income. In order to qualify for this transfer, the applicant must provide a letter from the Portland Housing Bureau certifying that this affordability standard and any administrative requirements have been met. The letter must be submitted before a building permit can be issued for the development, but is not required in order to apply for a land use review;
 - b. A site where trees that are at least 12 inches in diameter are preserved. The maximum amount of floor area that may be transferred for each preserved tree is indicated in Table 120-4, however the maximum amount of FAR that can be transferred may not exceed the total amount of unused FAR on the site. This transfer provision does not apply to dead, dying or dangerous, or nuisance trees. To qualify for this transfer, a report is required from the City Forester or a certified arborist documenting that the trees to be preserved are not nuisance trees and are not dead, dying or dangerous; or
 - c. A site that contains a Historic or Conservation Landmark or a contributing resource in a Historic or Conservation District. Sites that are eligible to send floor area through this transfer are allowed to transfer:
 - (1) Unused FAR up to the maximum FAR allowed by the zone; and
 - (2) An additional amount equivalent to 50 percent of the maximum FAR for the zone. To qualify to transfer this additional amount of FAR, the Bureau of Development of Services must verify that the landmark or contributing resource on the site meets one of the following:
 - If the building is classified as Risk category I or II, as defined in the Oregon Structural Specialty Code, it has been shown to meet or exceed the American Society of Civil Engineers (ASCE) 41- BPOE improvement standard as defined in City of Portland Title 24.85;

- If the building is classified as Risk category III or IV, as defined in the Oregon Structural Specialty Code, it has been shown to meet or exceed the ASCE41- BPON improvement standard as defined in City of Portland Title 24.85; or
 - The owner of the landmark or contributing resource has entered into a phased seismic agreement with the City of Portland as described in Section 24.85.
2. Receiving site. The transfer must be to a site zoned RM1, RM2, RM3, RM4, RX, CM1, CM2, CM3, or CE outside of the Central City plan district. Transferring to a site zoned RMP is prohibited. Transferring to a site where a Historic or Conservation Landmark or a contributing structure in a Historic or Conservation District has been demolished within the past ten years is prohibited unless the landmark or contributing structure was destroyed by fire or other causes beyond the control of the owner, the only structure on the site that was demolished was an accessory structure, or the demolition was approved through demolition review.
 3. Maximum increase in FAR. An increase in FAR on the receiving site of more than 1 to 1 from a transfer is prohibited. In addition, the total FAR on the receiving site, including FAR from transfers and bonuses, may not exceed the overall maximum FAR with other bonuses stated in Table 120-5.
 4. Covenants. The property owner must execute a covenant with the City that meets the requirements of Section 33.700.060 and is attached to, and recorded with, the deeds of both the site transferring and the site receiving the density. The covenant must reflect the respective increase and decrease of potential FAR. In addition, the covenant for the site where trees will be preserved must:
 - (a) Require that all trees be preserved for at least 50 years; and
 - (b) Require that any tree covered by the covenant that is dead, dying or dangerous be removed and replaced within a 12-month period. The trees must be determined to be dead, dying, or dangerous by the City Forester or a certified arborist. If a tree covered by the covenant is removed in violation of the requirements of this Section, or is dead, dying, or dangerous as the result of a violation, Tree Review is required.

Table 120-4				
Transferable Floor Area for Tree Preservation in Multi-Dwelling Zones				
Diameter of Tree Preserved	Transferable Floor Area for Each Tree (by zone)			
	RM1	RM2	RM3	RM4 & RX
12 to 19 inches	1,000 sq. ft.	1,500 sq. ft.	2,000 sq. ft.	4,000 sq. ft.
20 to 35 inches	2,000 sq. ft.	3,000 sq. ft.	4,000 sq. ft.	8,000 sq. ft.
36 inches or greater	4,000 sq. ft.	6,000 sq. ft.	8,000 sq. ft.	16,000 sq. ft.

33.120.211 Floor Area Bonus Options

- A. Purpose and description.** The bonus options allow additional floor area as an incentive for development that includes affordable housing, family-sized units, or units that are physically accessible to people of all abilities. The bonus options are designed to allow additional development intensity in a manner that is consistent with the purposes of the multi-dwelling zones.
- B. General floor area bonus regulations.**
1. The floor area bonus options in this section are only allowed in the RM1, RM2, RM3, RM4, and RX zones outside the Central City and Gateway plan districts. Sites where a Historic or Conservation Landmark or a contributing structure in a Historic or Conservation District has been demolished within the past ten years are not eligible to use bonus options unless the landmark or contributing structure was destroyed by fire or other causes beyond the control of the owner, the only structure on the site that was demolished was an accessory structure, or the demolition was approved through demolition review.
 2. More than one bonus may be used up to the overall maximum per site stated in Table 120-5. Adjustments to the maximum amount of floor area obtainable through bonuses are prohibited.
 3. The increment of additional FAR allowed per bonus is stated in Table 120-5 and described in Subsection C.
 4. The bonus option standards must be met in full to receive the bonus.

Table 120-5 Summary of Bonus FAR				
	RM1	RM2	RM3	RM4 & RX
Overall Maximum Per Site [1]				
Maximum FAR with deeper housing affordability bonus (see 33.120.211.C.2)	2 to 1	3 to 1	4 to 1	7 to 1 or 6 to 1 [3]
Maximum FAR with other bonuses [2]	1.5 to 1	2.25 to 1	3 to 1	6 to 1 or 4.5 to 1 [3]
Increment of Additional FAR Per Bonus				
Inclusionary Housing (see 33.120.211.C.1)	0.5 to 1	0.75 to 1	1 to 1	2 to 1 or 1.5 to 1 [3]
Deeper Housing Affordability (see 33.120.211.C.2)	1 to 1	1.5 to 1	2 to 1	3 to 1
Three-Bedroom Units (see 33.120.211.C.3)	0.25 to 1	0.4 to 1	0.5 to 1	1 to 1 or 0.75 to 1 [3]
Visitable Units (see 33.120.211.C.4)	0.25 to 1	0.4 to 1	0.5 to 1	1 to 1 or 0.75 to 1 [3]

[1] Overall maximum FAR includes FAR received from a transfer.

[2] Other bonuses are the Inclusionary Housing, Three-Bedroom Units, and Visitable Units bonuses.

[3] The lower FAR applies in the RM4 zone in Historic and Conservation districts.

C. Bonus options.

1. Inclusionary housing bonus option. Maximum FAR may be increased as stated in Table 120-5 if one of the following is met:
 - a. Mandatory inclusionary housing. Bonus FAR is allowed up to the maximum with inclusionary housing bonus stated in Table 120-5 for development that triggers the requirements of 33.245, Inclusionary Housing. To qualify for this bonus, the applicant must provide a letter from the Portland Housing Bureau certifying that the regulations of 33.245 have been met; or
 - b. Voluntary inclusionary housing. Bonus FAR is allowed up to the maximum with inclusionary housing bonus stated in Table 120-5 when one of the following voluntary bonus options is met:
 - (1) Bonus FAR is allowed for projects that voluntarily comply with the standards of 33.245.040 and 33.245.050. To qualify for this bonus, the applicant must provide a letter from the Portland Housing Bureau certifying that the regulations of 33.245 have been met. The letter must be submitted before a building permit can be issued for the development, but is not required in order to apply for a land use review; or

- (2) Bonus FAR is allowed in exchange for payment into the Affordable Housing Fund. For each square foot of floor area purchased a fee must be paid to the Portland Housing Bureau (PHB). The Portland Housing Bureau collects and administers the Affordable Housing Fund and determines the fee. PHB determines the fee per square foot and updates the fee at least every three years. The fee schedule is available from the Bureau of Development Services. To qualify for this bonus, the applicant must provide a letter from PHB documenting the amount that has been contributed. The letter is required to be submitted before a building permit can be issued for development but is not required in order to apply for a land use review.
2. Deeper housing affordability bonus option. Bonus FAR is allowed up to the maximum with deeper housing affordability bonus as stated in Table 120-5 when at least 50 percent of all the dwelling units on the site are affordable to those earning no more than 60 percent of area median family income or an affordability level established by Title 30. Projects taking advantage of this bonus are also allowed an additional 10 feet of base height and an additional 10 percent of building coverage beyond the limits for the zone stated in Table 120-3. To qualify for this bonus the applicant must provide a letter from the Portland Housing Bureau certifying that the development meets the affordability requirement of this bonus and any administrative requirements of the Portland Housing Bureau. The letter must be submitted before a building permit can be issued for the development but is not required in order to apply for a land use review.
3. Three-bedroom unit bonus option. Bonus FAR is allowed up to the maximum with three-bedroom unit bonus as stated in Table 120-5 if at least 50 percent of the dwelling units on the site have at least three bedrooms and are affordable to those earning no more than 100 percent of the area median family income. To qualify for this bonus, the applicant must provide a letter from the Portland Housing Bureau certifying that the required three-bedroom units meet the affordability requirement of this bonus and any administrative requirements of the Portland Housing Bureau.
4. Visitable units bonus option. Bonus FAR is allowed up to the maximum with visitable units bonus as stated in Table 120-5 when at least 25 percent of all the dwelling units on the site meet the following visitability standards, except that this bonus is not available for projects with buildings that are required by the Oregon Structural Specialty Code to include Type A or Type B accessible units:
 - a. Visitable entrance. At least one entrance must be accessible via a route that does not have any stairs between it and the street lot line or an on-site parking space. The slope of the route may not exceed 1:8;
 - b. Visitable bathroom. At least one bathroom with a sink and toilet must be designed to accommodate an unobstructed circle that is at least 60-inches in diameter. As an alternative, the bathroom may be designed to accommodate an unobstructed area that is comprised of two rectangles that are at least 36 inches by 60 inches, and oriented at right angles to each other. See Figure 120-1. The visitable bathroom must be on the same floor as the visitable entrance or be accessible from the visitable entrance via a ramp, elevator or lift. Adjustments are prohibited;

- c. Visitable living area. There must be at least 200 square feet of living area on the same floor as the visitable entrance or 200 square feet of living area must be accessible from the visitable entrance via a ramp, elevator or lift. Adjustments are prohibited; and
- d. Visitable doors. All door openings between and including the visitable entrance, visitable living area, and the visitable bathroom must be at least 34 inches wide. Adjustments are prohibited.

33.120.212 Maximum Density

- A. Purpose.** The maximum number of dwellings per unit of land, the maximum density, is controlled in the RMP zone so that housing can match the availability of public services and the availability of support commercial areas. The standards also allow the housing density to be matched with the carrying capacity of the land. In addition, the density standard is used as one type of control of overall building bulk. The bonus density options allow additional floor area as an incentive for providing affordable housing.
- B. Maximum density.** The maximum density for the RMP zone is stated in Table 120-3. There is no maximum density for any other multi-dwelling zone. All new housing built, or converted from other uses, must be on sites large enough to comply with the density standards. The number of units allowed on a site is based on the presumption that all site development standards will be met. The allowed density is not a special right that justifies adjusting other development standards.
- C. RMP zone affordable housing bonus option.** In the RMP zone, maximum density can be increased up to the maximum with RMP affordable housing bonus stated in Table 120-3 when at least 50 percent of all of the dwelling units on the site are affordable to those earning no more than 60 percent of area median family income. To qualify for this bonus the applicant must provide a letter from the Portland Housing Bureau certifying that the development meets the affordability requirement of this bonus and any administrative requirements of the Portland Housing Bureau. The letter must be submitted before a building permit can be issued for development, but is not required in order to apply for a land use review.
- D. Transfer of density.**
 - 1. Density may be transferred from a site zoned RMP to a site zoned RM1, RM2, RM3, or RM4 outside of the Central City plan district. When density will be transferred from a site zoned RMP, one dwelling unit is equal to 800 square feet of floor area. Transfers of density or FAR to a site zoned RMP is prohibited.
 - 2. The property owner must execute a covenant with the City that is attached to, and recorded with, the deed of both the site transferring and the site receiving the density reflecting the respective increase and decrease of potential density. The covenant for the receiving site must meet the requirements of Section 33.700.060.

Figure 120-1
Visitable Bathroom Clearances

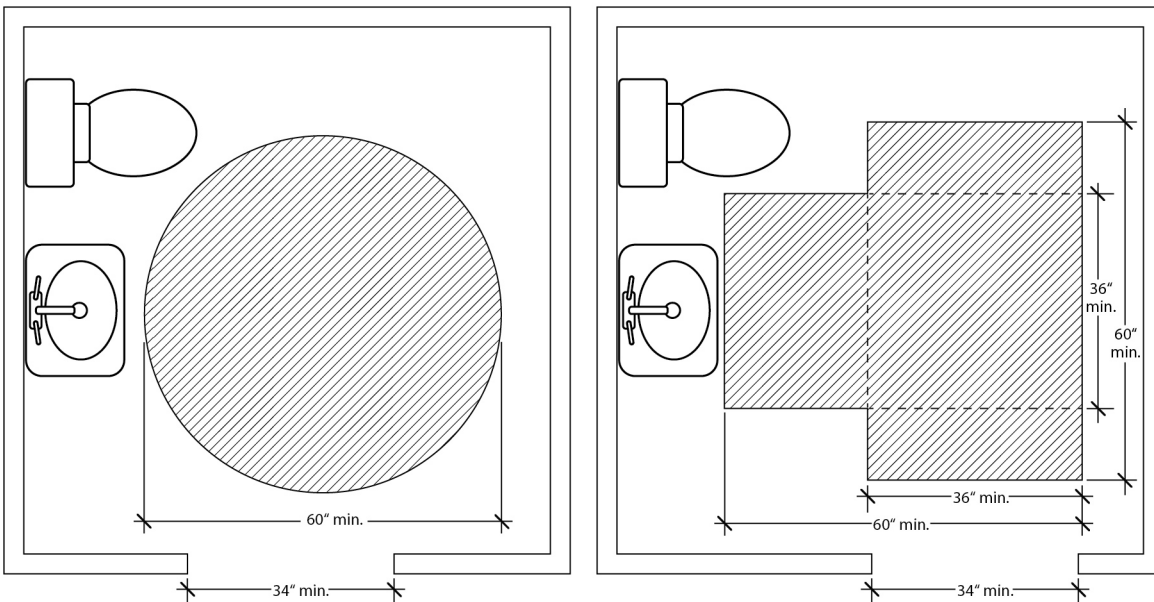

33.120.213 Minimum Density

- A. Purpose.** The minimum density standards ensure that the service capacity is effectively utilized and that the City's housing goals are met. The standards also ensure that incremental development will not preclude the ability to meet the intended development intensity of the zoning of a site.
- B. Minimum density.** The minimum density requirements for the multi-dwelling zones are stated in Table 120-3. Group living uses are exempt from minimum density requirements. Land within an Environmental zone may be subtracted from the calculation of minimum density.
1. If units are being added to a site with an existing building with residential units, the minimum density is reduced by two units.
 2. In the RMP zone, if maximum density is two units then minimum density is two units. If maximum density is one unit, minimum density is one unit.
 3. On sites where trees that are 12 or more inches in diameter are proposed for preservation, minimum density may be reduced as follows:
 - a. The maximum allowed reduction in minimum density is shown in Table 120-6.
 - b. When this provision is used to reduce density, the owner must execute a covenant with the City. The covenant is not required if the site is also part of a proposed Land Division. The covenant must:
 - (1) Require that all trees used to reduce the minimum density be preserved for at least 10 years;

- (2) Allow trees used to reduce the minimum density that die, are dying, or become dangerous to be removed and replaced within the 10 year preservation period. The trees must be determined to be dead, dying, or dangerous by an arborist, and a Title 11 tree permit must be obtained. If a tree used to reduce the minimum density is dead, dying, or dangerous as the result of a violation, Tree Review is required; and
- (3) The covenant must meet the requirements of Section 33.700.060 and be recorded before a development permit is issued.

Table 120-6 Reduction in Minimum Residential Density from Tree Preservation		
Required Minimum Residential Density	No. of 12-Inch Trees To Be Preserved	Reduction of Minimum Residential Density
Up to 7 units	1	1
8-12 units	1	1
	2 or more	2
13-17 units	1	1
	2	2
	3 or more	3
18 or more units	1	1
	2	2
	3	3
	4 or more	4

33.120.215 Height

- A. Purpose.** The height standards serve several purposes:
 - They promote a reasonable building scale and relationship of one residence to another;
 - They promote options for privacy for neighboring properties; and
 - They reflect the general building scale of multi-dwelling development in the City's neighborhoods.
- B. Height standard.**
 1. Base height. The base heights allowed in the multi-dwelling zones are stated in Table 120-3. The maximum height standard for institutional uses is stated in 33.120.275, Development Standards for Institutions. The maximum height standards for detached accessory structures are stated in 33.120.280, Detached Accessory Structures. In the RM4 zone the base height is 75 feet, except as follows:
 - a. On sites that are not within a Historic or Conservation district but are within 500 feet of a transit street with 20-minute peak hour service the base height is 100 feet; and
 - b. On sites within 1,000 feet of a transit station the base height is 100 feet, including on sites that are within a Historic or Conservation district.

2. Step-down height. In the following situations, the base height is reduced, or stepped-down:
 - a. On the portion of a site within 25 feet of a lot line abutting a site zoned RF through R2.5, the step-down height is 35 feet. See Figure 120-2. Sites with property lines that abut a single-dwelling zone for less than a 5-foot length are exempt from this standard; and
 - b. On the portion of the site within 15 feet of a lot line that is across a local service street or alley from a site zoned RF through R2.5 the following step-down height limits apply. The limits do not apply to portions of buildings within 100 feet of a transit street.
 - (1) The step-down height is 45 feet for sites in the RM2, RM3, RM4, and RX zones.
 - (2) The step-down height is 35 feet for sites in the RM1 and RMP zones.

Figure 120-2
Step-Down Height Adjacent to Single-Dwelling Zones

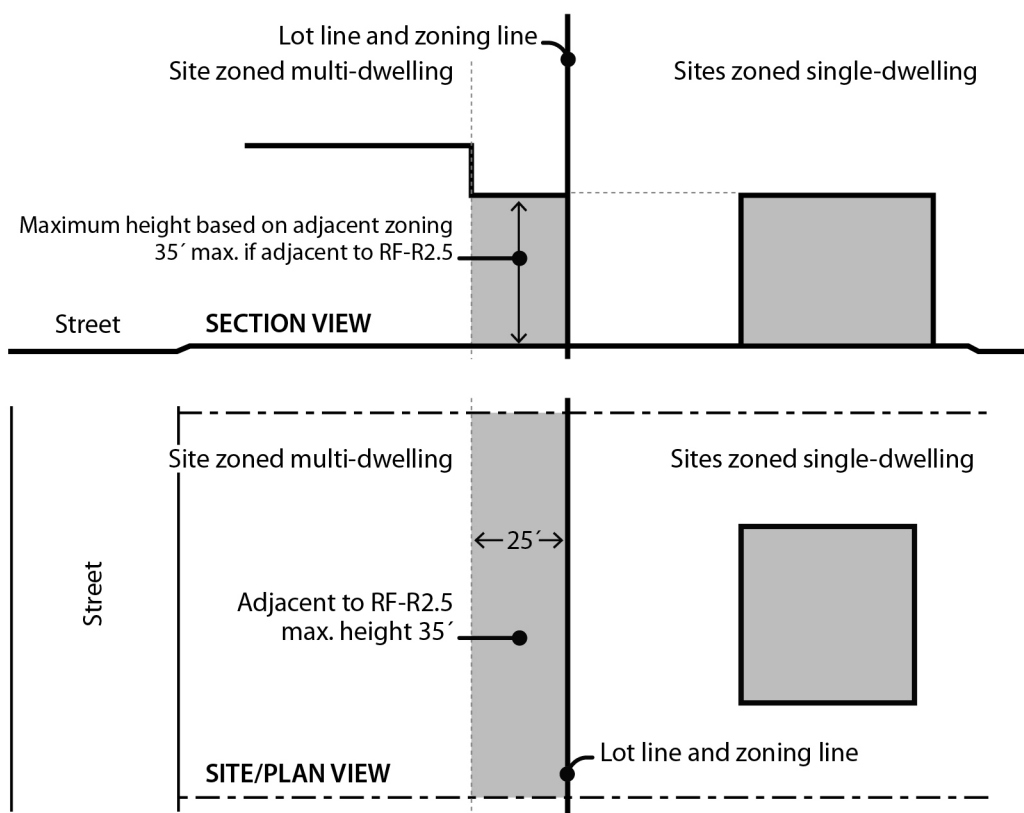

C. Exceptions to the maximum height.

1. Chimneys, vents, flag poles, satellite receiving dishes, and other similar items, with a width, depth, or diameter of 5 feet or less may extend above the height limit, as long as they are attached to a building and do not exceed 5 feet above the top of the

highest point of the roof. If they are greater than 5 feet in width, depth, or diameter, they are subject to the height limit.

2. Parapets and railings. Parapets and rooftop railings may extend 4 feet above the height limits.
3. Walls and fences. Walls or fences located between individual rooftop decks may extend 6 feet above the height limit provided that the wall or fence is set back at least 4 feet from the edges of the roof.
4. Rooftop mechanical equipment and stairwell enclosures that provide rooftop access may extend above the height limit as follows, provided that the equipment and enclosures are set back at least 15 feet from all roof edges on street facing facades.
 - a. Elevator mechanical equipment may extend up to 16 feet above the height limit; and
 - b. Other mechanical equipment and stairwell enclosures that cumulatively cover no more than 10 percent of the roof area may extend up to 10 feet above the height limit.
5. Antennas, utility power poles, and public safety facilities are exempt from the height limit.
6. Small wind turbines are subject to the standards of Chapter 33.299.
7. Roof mounted solar panels are not included in height calculations, and may exceed the maximum height limit as follows:
 - a. For flat roofs or the horizontal portion of mansard roofs, the roof mounted solar panel may extend up to 5 feet above the top of the highest point of the roof.
 - b. For pitched, hipped, or gambrel roofs, the roof mounted solar panel must be mounted no more than 12 inches from the surface of the roof at any point, and may not extend above the ridgeline of the roof. The 12 inches is measured from the upper side of the solar panel.

33.120.220 Setbacks

- A. Purpose.** The building setback regulations serve several purposes:
- They maintain light, air, separation for fire protection, and access for fire fighting;
 - They reflect the general building scale and placement of multi-dwelling development in the City's neighborhoods;
 - They promote a reasonable physical relationship between residences;
 - They promote options for privacy for building residents and neighboring properties;
 - They provide adequate flexibility to site a building so that it may be compatible with the neighborhood, fit the topography of the site, allow for required outdoor areas, and allow for architectural diversity;
 - Setback requirements along transit streets create an environment that is inviting to pedestrians and transit users; and

- They provide room for a car to park in front of a garage door without overhanging the street or sidewalk, and they enhance driver visibility when backing onto the street.

B. Minimum building setbacks. The required minimum building setbacks apply to all buildings and structures on the site except as specified in this section. Setbacks for parking areas are in Chapter 33.266.

1. Generally. The required minimum building setbacks, if any, are stated in Table 120-3. In the RM3 and RM4 zones, the minimum side and rear building setbacks apply as follows:
 - a. Buildings that are up to 55 feet tall. The required minimum side and rear building setback for buildings that are up to 55 feet tall is 5 feet. Minor projections allowed by Paragraph 33.120.215.C do not count toward this height measurement; and
 - b. Buildings more than 55 feet tall. The required minimum side and rear building setback for buildings that are more than 55 feet tall is 10 feet from a side or rear lot line that is not a street lot line, and 5 feet from a side or rear lot line that is a street lot line.
2. Eastern Pattern Area minimum rear building setback.
 - a. Minimum rear building setback. In the RM1, RM2, RM3 and RM4 zones in the Eastern Pattern Area the required minimum rear building setback is an amount equal to 25 percent of the total depth of the site. No more than 50 percent of the Eastern Pattern Area rear setback can be vehicle area. The Eastern Pattern Area is shown on Map 120-3.
 - b. Exemptions. The following are exempt from the Eastern Pattern Area minimum rear building setback. When a site is exempt from the Eastern Pattern Area minimum rear building setback, the base zone required minimum rear building setback stated in Table 120-3 applies:
 - (1) Corner lots and lots that are up to 100 feet deep are exempt from the Eastern Pattern Area minimum rear building setback; and
 - (2) Sites where at least 10 percent of the total site area is outdoor common area and the common areas measure at least 30 feet in all directions are exempt from the Eastern Pattern Area minimum rear setback.
3. Exceptions to the required building setbacks.
 - a. Setback matching. The minimum front and side street building setbacks and the setback of decks, balconies, and porches may be reduced to match the setback on an abutting lot.
 - b. Raised ground floor. In the RM2 and RM3 zones the minimum front building setback may be reduced to 5 feet, and in the RM4 zone the minimum front and side street building setbacks may be reduced to zero feet, for buildings where the finished floor of ground floor residential units is at least 2 feet above the grade of the closest adjoining sidewalk. This exception does not apply in the Eastern Pattern Area shown on Map 120-3.

- c. Courtyard. Except in the Eastern Pattern Area shown on Map 120-3, the required minimum front or side street setback may be reduced to zero in the RM2 and RM3 zones, and may be reduced to 5 feet in the RM1 zone when:
 - (1) At least 20 feet or 25 percent of the length of the street-facing building facade, whichever is greater, is setback at least 40 feet from the street lot line;
 - (2) At least half of the area between the setback portion of the building and the street lot line is landscaped to at least the L1 standard and the setback includes no vehicle area; and
 - (3) The finished floor of the ground floor is at least 2 feet above the grade of the closest abutting sidewalk.
- d. Ground floor commercial. The required minimum front or side street setbacks may be reduced to zero in the RM2, RM3 and RM4 zones when the ground floor includes a commercial use and at least 50 percent of the length of the ground-floor street-facing façade is in a commercial use or is an indoor common area, such as an indoor recreation facility or community room. This exception does not apply in the Eastern Pattern Area shown on Map 120-3.
- e. Environmental zone. The required minimum front and street building setback and garage entrance setback may be reduced to zero where any portion of the site is in an environmental overlay zone. Where a side lot line is also a street lot line the side building and garage entrance setback may be reduced to zero. All other provisions of this Title apply to the building and garage entrance.
- f. Split zoning. No setbacks are required from an internal lot line that is also a zoning line on sites with split zoning.
- g. Alley. No side or rear building setback is required from a lot line abutting an alley.
- h. Land divisions with existing development. When a dedication of public right-of-way along the frontage of an existing street is required as part of a land division, the minimum front or side setback between an existing building and a lot line that abuts the right-of-way may be reduced to zero. Eaves on an existing building may extend one foot into the reduced setback, except that they may not extend into the right-of-way. Future additions or development must meet required minimum setbacks.
- i. Eastern Pattern Area. In the Eastern Pattern Area, the footprint of buildings containing only indoor common area, such as recreational facilities or tenant community rooms, may cover up to 25 percent of the Eastern Pattern Area minimum rear building setback. In this case, the building must be set back at least 5 feet from the rear lot line.
- j. Inner Pattern Area. In the RM2, RM3, and RM4 zones in the Inner Pattern Area, on sites that abut a Civic or Neighborhood Corridor shown on Map 120-1, no setback is required from a lot line that abuts a property that also has a lot line on a Civic or Neighborhood Corridor. See Figure 120-3. However, windows in the

walls of dwelling units must be setback a minimum of 5 feet from a lot line that abuts another property and this setback area must be a minimum width of 12 feet or the width of the residential window, whichever is greater.

Figure 120-3
No setbacks between properties on Civic or Neighborhood Corridors

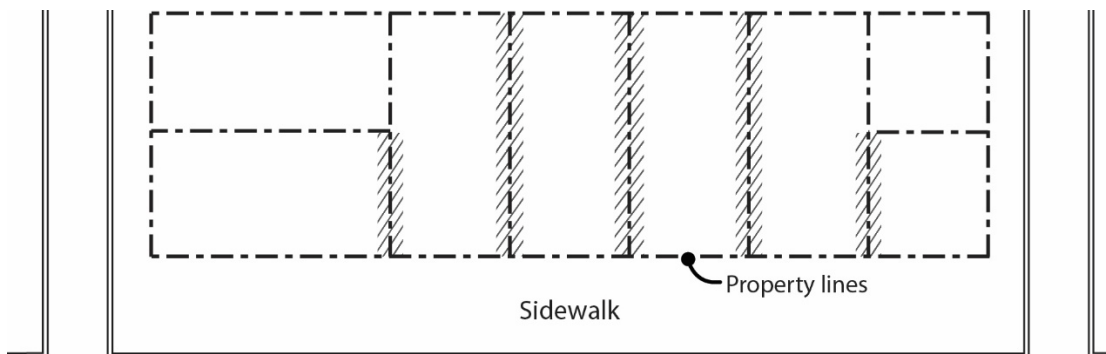

CIVIC OR NEIGHBORHOOD CORRIDOR

 Locations where no setbacks are required.

C. Maximum building setbacks.

1. Maximum building setbacks on a transit street or in a Pedestrian District. The required maximum building setbacks, if any, are stated in Table 120-5, and apply only to buildings that are enclosed on all sides. The maximum building setbacks on a transit street or in a Pedestrian District are as follows. At least 50 percent of the length of the ground level street-facing façade of the building must meet the maximum building setback standard:
 - a. Applying the standard.
 - (1) Where an existing building is being altered, the standards apply to the ground level, street-facing facade of the entire building. See Figures 120-3 and 120-4.
 - (2) Where there is more than one building on the site, the standards of this paragraph apply to the combined ground level, street-facing facades of all the buildings. See Figures 120-6 and 120-7.
 - (3) For buildings where all of the floor area is in residential use, the street-facing facade of an open porch that meets the following standards is included as part of the ground level, street-facing facade of the building:
 - For houses, attached houses, manufactured homes and duplexes, the porch must be at least 25 square feet in area. For multi-dwelling structures, the porch must be at least 9 feet wide and 7 feet deep;
 - The porch must have at least one entrance facing the street; and
 - The porch must have a roof that is:
 - No more than 12 feet above the floor of the porch; and

- At least 30 percent solid. This standard may be met by having 30 percent of the porch area covered with a solid roof, or by having the entire area covered with a trellis or other open material if no more than 70 percent of the area of the material is open.
- b. Outside a Pedestrian District. Where the site is not in a Pedestrian District:
 - (1) One transit street. Where the site is adjacent to one transit street, the standard must be met on the transit street frontage;
 - (2) Two non-intersecting transit streets. Where the site is adjacent to two transit streets that do not intersect:
 - The standard must be met on the frontage of the street with the highest transit classification. If both streets have the same highest classification, the applicant may choose on which street to meet the standard;
 - If one of the transit streets intersects a City Walkway, the standard must be met along both the street with the highest transit classification and the City Walkway;
 - (3) Two or more intersecting transit streets. Where the site is adjacent to two or more intersecting transit streets, the standard must be met on the frontages of the two streets with the highest transit classifications. If more than two streets have the same highest transit classification, the applicant may choose on which two streets to meet the standard;
- c. In a Pedestrian District. Where the site is in a Pedestrian District, the maximum building setback standard applies to all street frontages, with the following exceptions:
 - (1) Through lots. If the site is a through lot, the maximum setback standard only applies to the street with the highest transit street classification. If multiple streets have the same highest transit street classification, the applicant may choose on which street to apply the standard.
 - (2) Three or more street frontages. If the site has street lot lines on three or more streets, the maximum setback standard only applies to two of the streets. When this occurs, the standard must be applied to the streets with the highest transit street classifications. If multiple streets have the same highest transit street classification, the applicant may choose on which streets to apply the standard.

Figure 120-4
Alteration to Existing Building in Conformance with Maximum Setback Standard

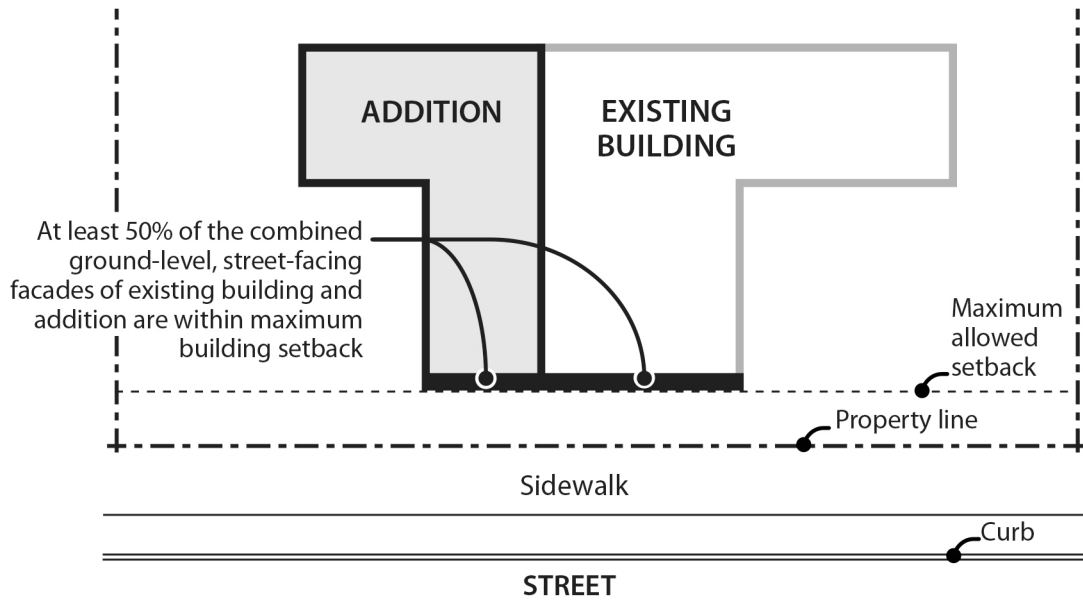
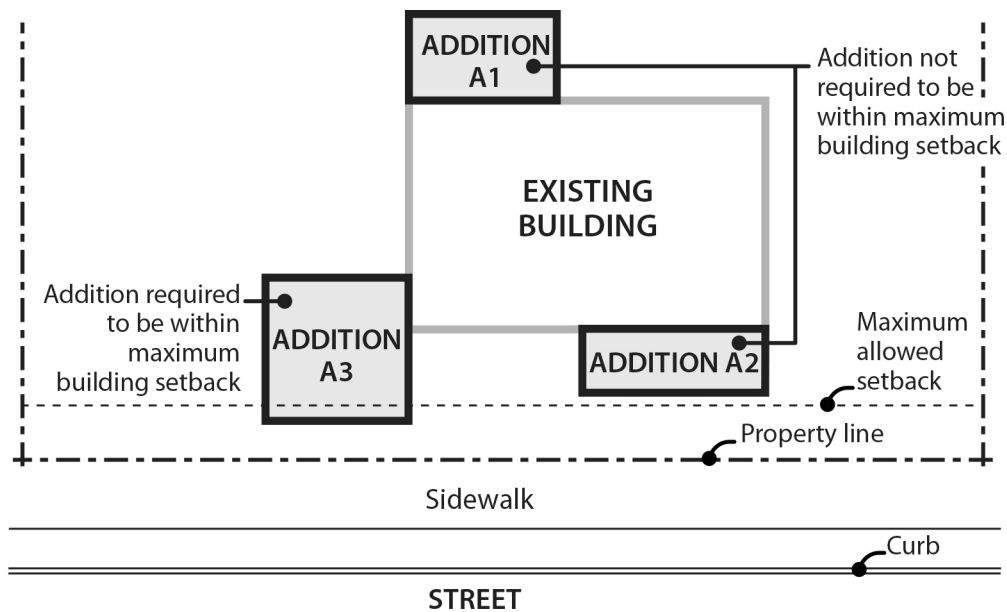

Figure 120-5
Alterations to Existing Building



Notes:

Addition A1. Not subject to maximum setback standard because addition has no street-facing facade.

Addition A2. Brings building closer to conformance with maximum setback standard because it does not increase the length of the street-facing facade, and it brings building closer to maximum building setback line.

Addition A3. Because addition increases length of street facing facade, 100% of addition facade must be within maximum setback until maximum setback standard for entire building is met.

Figure 120-6
Calculating Maximum Building Setback When More Than One Building On Site

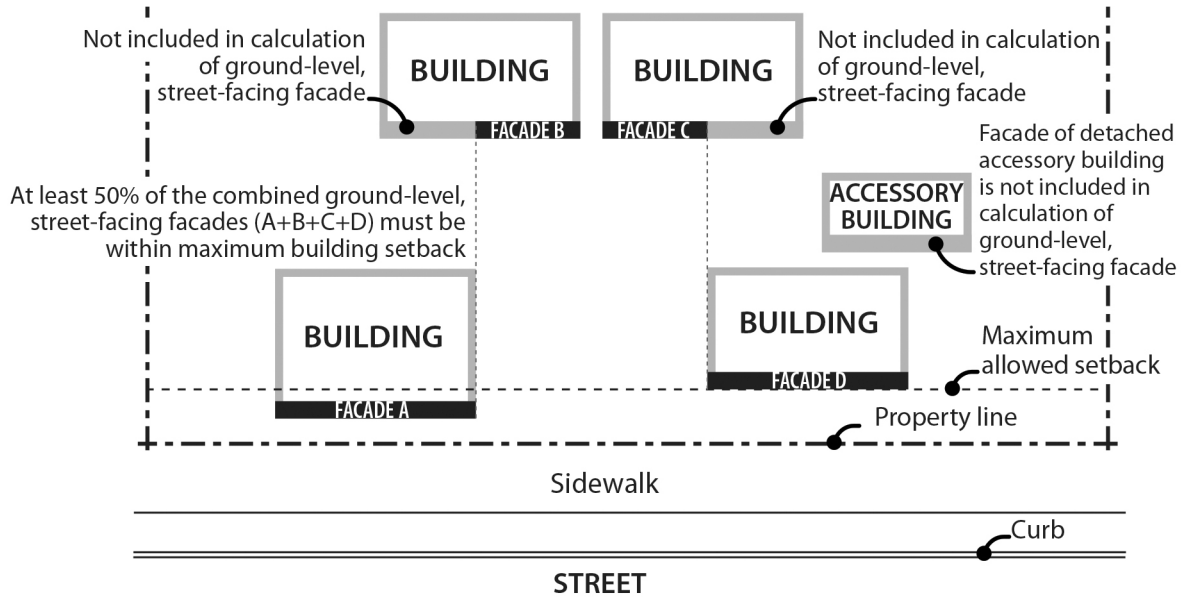
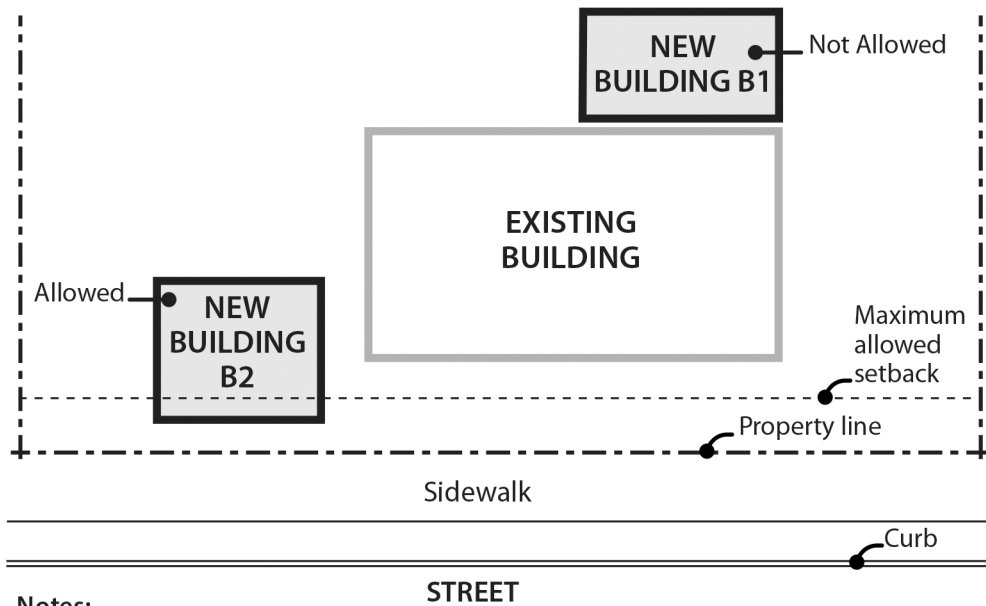

Figure 120-7
New Buildings On Sites With Buildings That Do Not Meet The Maximum Building Setback



Notes:

New Building B1. Not allowed because it moves site further out of conformance with maximum setback standard.

New Building B2. Because building increases length of combined street-facing facade on the site, 100% of building facade must be within maximum setback until maximum setback standard for site is met.

2. Exemptions.
 - a. Flag lots. Flag lots are exempt from the maximum setback standards of this section.
 - b. Detached accessory structures. Detached accessory structures are exempt from the maximum setback standards of this section. The street-facing facades of detached accessory structures do not count towards meeting maximum setback standards. See Figure 120-6.

D. Extensions into required building setbacks.

1. The following features of a building may extend into a required building setback up to 20 percent of the depth of the setback, except as indicated. However, the feature must be at least 3 feet from a lot line, except as allowed in 33.120.270, Alternative Development Options:
 - a. Chimneys, fireplace inserts and vents, mechanical equipment, and fire escapes;
 - b. Wheelchair ramps, water collection cisterns and stormwater planters that do not meet the standards of Paragraph D.4;
 - c. Decks, stairways, and uncovered balconies that do not meet the standard for Paragraph D.4, but only along a street lot line; and
 - d. Bays and bay windows but only along a street lot line and must meet the following requirements:
 - (1) Each bay and bay window may be up to 12 feet long, but the total area of all bays and bay windows on a building facade cannot be more than 30 percent of the area of the facade;
 - (2) At least 30 percent of the area of the bay which faces the property line requiring the setback must be glazing or glass block; and
 - (3) Bays and bay windows must cantilever beyond the foundation of the building.
2. Building eaves may project up to 2 feet into a required setback, provided the eave is at least 3 feet from a lot line.
3. Canopies and awnings may extend up to 5 feet into a required setback along a street lot line.
4. The following minor features may extend into entire required building setbacks:
 - a. Utility connections attached to the building that are required to provide services, such as water electricity and other similar utility services;
 - b. Gutters and downspouts that drain stormwater off a roof of the structure;
 - c. Stormwater planters that are no more than 2-1/2 feet above the ground;

- d. Water collection cisterns that are 6 feet or less in height;
 - e. Attached decks, stairs, and ramps that are no more than 2-1/2 feet above the ground. However, stairways and wheelchair ramps that lead to one entrance on the street-facing facade of a building are allowed to extend into the required street setbacks regardless of height above ground; and
 - f. On lots that slope down from the street, vehicular or pedestrian entry bridges that are no more than 2-1/2 feet above the average sidewalk elevation.
5. Detached accessory structures. The setback standards for detached accessory structures including detached mechanical equipment are stated in 33.120.280 below. Fences are addressed in 33.120.285, below. Detached accessory dwelling units are addressed in Chapter 33.205.

E. Garage entrance and structured parking setback.

1. Garage entrance setback. The garage entrance setback is stated in Table 120-3. See Chapter 33.910, Definitions, for a description. The walls of the garage structure are subject to 33.120.283 and the applicable front, side, or rear building setbacks.
 - a. In the RM2, RM3, RM4, and RX zone, the garage entrance must be either 5 feet or closer to the street lot line, or 18 feet or farther from the street lot line. If the garage entrance is located within 5 feet of the front lot line, it may not be closer to the lot line than the facade of the residential portion of the building.
 - b. Exceptions. No setback is required from a lot line abutting an alley. However, the Bureau of Transportation may require the garage entrance to be set back to ensure adequate turning radius into the garage.
2. Setbacks for structured parking. Structured parking that allows exiting in a forward motion is subject to the setback requirements for buildings. Structured parking that does not allow exiting in a forward motion is subject to the garage entrance setback standard stated in Table 120-3.

33.120.225 Building Coverage

- A. Purpose.** The building coverage standards, along with the height and setback standards, limit the overall bulk of structures. They assure that larger buildings will not have a footprint that overwhelms adjacent development. The standards help define the character of the different zones by determining how built-up a neighborhood appears.
- B. Maximum building coverage.** The maximum building coverages for all covered structures on the site are stated in Table 120-3. In the RM2 zone, maximum building coverage on sites that abut a Civic Corridor or Neighborhood Corridor shown on Map 120-1 is 70 percent of site area. Maximum building coverage on all other RM2 sites is 60 percent of site area.
- C. Exception.** Structured parking that is no more than 6 feet above grade at any point, except as indicated below, does not count toward building coverage if the structured parking does not have floor area above it, and the structured parking is covered by landscaping or an outdoor common area. Vehicle or pedestrian access into the structured parking is exempt from the calculation of grade, if the access is no more than 20 feet wide.

33.120.230 Building Length and Façade Articulation

- A. Purpose.** These standards, along with the height and setback standard, limit the bulk of buildings close to the street. These standards help ensure that large buildings will be divided into smaller components that relate to the scale and development patterns of Portland’s multi-dwelling residential areas and add visual interest and variety to the street environment.
- B. Maximum building length.** In the RM1, RM2, and RMP zones, the maximum building length for the portion of buildings located within 30 feet of a street lot line is 100 feet. The portions of buildings subject to this standard must be separated by a minimum of 10 feet. See Figure 120-8. Manufactured dwelling parks are exempt from this standard.

Figure 120-8
Maximum Building Length

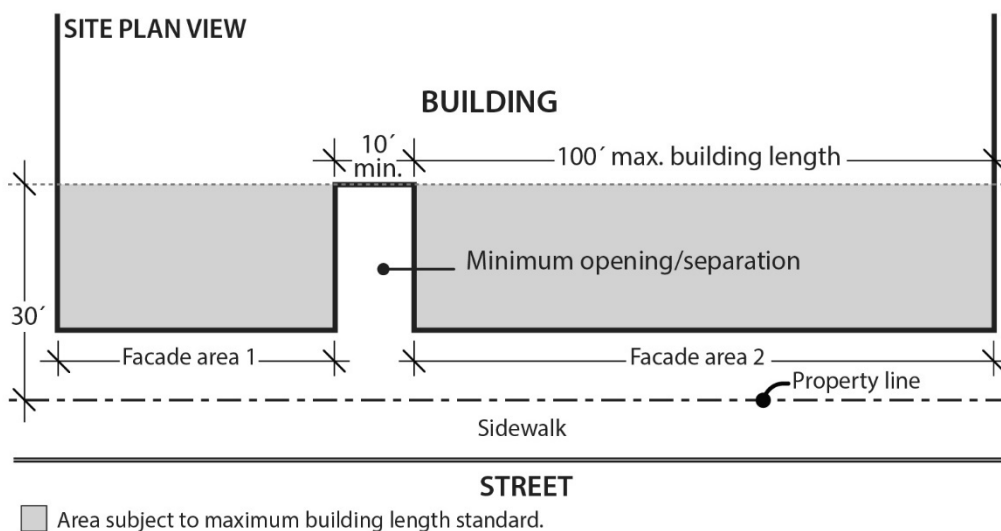

C. Façade articulation

- Where the standard applies. This standard applies in the RM2 through RM4 zones as follows:
 - In the RM2 zone, the standard applies to buildings more than 35 feet high that have facade areas of more than 3,500 square feet within 20 feet of a street property line.
 - In the RM3 and RM4 zones, the standard applies to buildings more than 45 feet high that have facade areas of more than 4,500 square feet within 20 feet of a street property line.
 - Portions of building facades that are vertically separated by a gap of at least 10 feet in width extending at least 30 feet in depth from the street property line are considered to be separate facade areas for the purposes of the facade area measurements. See Figure 120-8.

2. The standard. At least 25 percent of the area of a street-facing facade within 20 feet of a street lot line must be divided into facade planes that are off-set by at least 2 feet in depth from the rest of the facade. Facade area used to meet the facade articulation standard may be recessed behind, or project out from, the primary facade plane, but projections into street right-of-way do not count toward meeting this standard. See Figure 120-9.

Figure 120-9
Facade Articulation

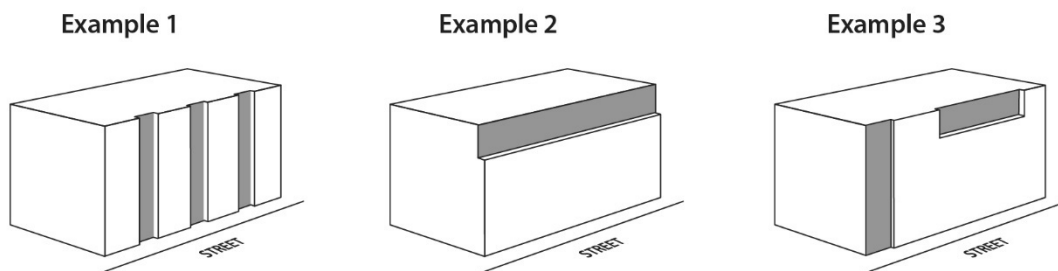

33.120.231 Main Entrances

A. Purpose. The main entrance standards:

- Together with the window and garage standards, ensure that there is a physical and visual connection between the living area of the residence and the street;
- Enhance public safety for residents and visitors and provide opportunities for community interaction;
- Ensure that the pedestrian entrance is visible or clearly identifiable from the street by its orientation or articulation; and
- Ensure a connection to the public realm for development on lots fronting both private and public streets by making the pedestrian entrance visible or clearly identifiable from the public street.

B. Where these standards apply.

1. The standards of this section apply to all residential structure types in the multi-dwelling zones except for accessory dwelling units, manufactured dwelling parks, and houseboat moorages. For multi-dwelling development, the standards apply only to residential structures that are located within 40 feet of a street lot line.
2. Where a proposal is for an alteration or addition to existing development, the standards apply only to the portion being altered or added.
3. On sites with frontage on both a private street and a public street, the standards apply to the site frontage on the public street. On all other sites with more than one street frontage, the standards apply to the transit street. If there is no transit street, the applicant may choose on which frontage to meet the standards. If there is more than one transit street, the standards apply to the street with the highest transit street classification. If all streets have the same transit street classification, the applicant may choose on which frontage to meet the standards.

4. Development on flag lots or on lots that slope up or down from the street with an average slope of 20 percent or more are exempt from these standards.
5. Subdivisions and PUDs that received preliminary plan approval between September 9, 1990, and September 9, 1995, are exempt from this standard.
6. Development on lots where any portion of the lot is in a special flood hazard area is exempt from the standard in Subsection D.

C. Main entrance.

1. Standard. At least one main entrance for each structure must:
 - a. Be within 8 feet of the longest street-facing wall of the structure; and
 - b. Either:
 - (1) Face the street. See Figure 120-10;
 - (2) Be at an angle of up to 45 degrees from the street; or
 - (3) Open onto a porch. See Figure 120-11. The porch must:
 - Be at least 25 square feet in area;
 - Have at least one entrance facing the street; and
 - Have a roof that is:
 - No more than 12 feet above the floor of the porch; and
 - At least 30 percent solid. This standard may be met by having 30 percent of the porch area covered with a solid roof, or by having the entire area covered with a trellis or other open material if no more than 70 percent of the area of the material is open.
2. Alternative for multi-dwelling structures. As an alternative to Paragraph C.1, an entrance to a multi-dwelling structure may face a courtyard if the courtyard-facing entrance is located within 60 feet of a street and the courtyard meets the following standards:
 - a. The courtyard must be at least 15 feet in width;
 - b. The courtyard must abut a street; and
 - c. The courtyard must be landscaped to at least the L1 level, or hard-surfaced for use by pedestrians.

- D. Distance from grade.** For houses, attached houses, manufactured homes, duplexes, triplexes, and fourplexes, the main entrance that meets Paragraph C.1 must be within 4 feet of grade. For the purposes of this Subsection, grade is the average grade measured at the outer most corners of the street facing facade. See Figure 120-12.

Figure 120-10
Main Entrance Facing the Street

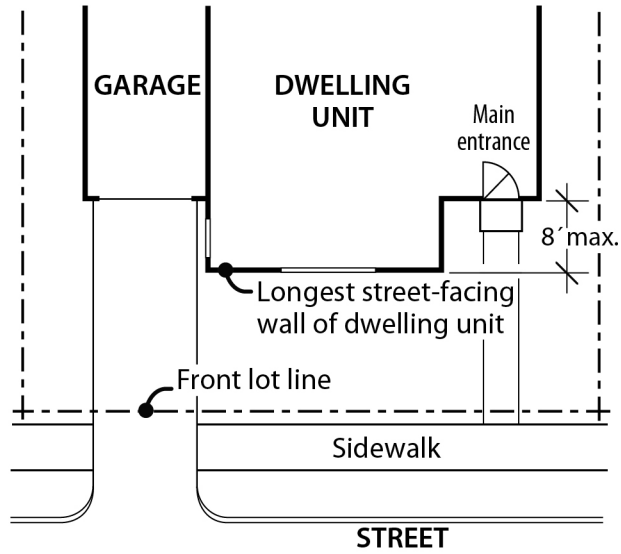

Figure 120-11
Main Entrance Opening Onto a Porch

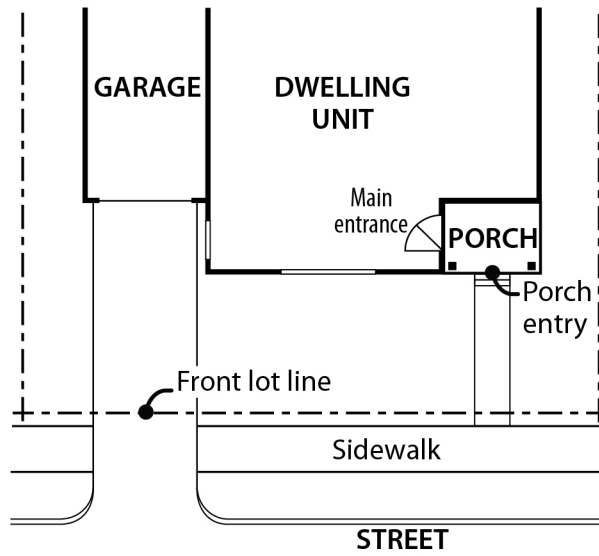
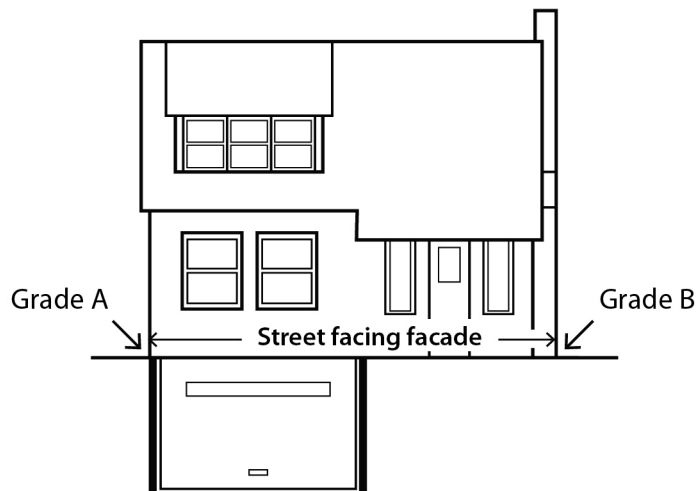

Figure 120-12
Calculation of Grade: (Elevation A + Elevation B) / 2



33.120.232 Street-Facing Facades

A. Purpose. The standards:

- Work with the main entrance and garage standards to ensure that there is a visual connection between the living area of the residence and the street;
- Enhance public safety by allowing people to survey their neighborhood from inside their residences; and
- Provide a pleasant pedestrian environment by preventing large expanses of blank facades along streets.

B. Where these standards apply.

1. The standards of this section apply to the street-facing facades of buildings that include any residential uses. The standards of this section do not apply in the RMP zone.
2. Where a proposal is for an alteration or addition to existing development, the applicant may choose to apply the standard either to the portion being altered or added, or to the entire street-facing facade.
3. Development on flag lots, and development on lots that slope up or down from the street with an average slope of 20 percent or more, is exempt from these standards.
4. Subdivisions and PUDs that received preliminary plan approval between September 9, 1990, and September 9, 1995, are exempt from Subsection C.
5. For structures subject to ground floor window standard in Subsection D, windows used to meet the ground floor window standard may also be used to meet the requirements of Subsection C.

- C. Windows.** At least 15 percent of the area of each facade that faces a street lot line must be windows or main entrance doors. Windows used to meet this standard must allow views from the building to the street. Glass block does not meet this standard. Windows in garage doors do not count toward meeting this standard, but windows in garage walls do count toward meeting this standard. To count toward meeting this standard a door must be at the main entrance and facing the street property line. Development on flag lots or on lots which slope up or down from the street with an average slope of 20 percent or more are exempt from these standards.
- D. Ground floor windows.** The following ground floor window standards apply to the portion of a building with ground floor commercial uses. For the purposes of this Paragraph, ground floor wall area includes exterior wall area from 2 feet to 10 feet above the finished grade. Required ground floor windows must be windows in walls or entrances that allow views into working area or display windows that are at least 24 inches deep set into a wall. The bottom of qualifying windows must be no more than 4 feet above the adjacent exterior grade:
1. Windows must cover at least 40 percent of the ground floor wall area of the portion of a building that has a ground floor commercial use when the ground floor wall is located closer than 5 feet from a street lot line.
 2. Windows must cover at least 25 percent of the ground floor wall area of the portion of building that has a ground floor commercial use when the ground floor wall is located 5 feet or more from a street lot line.

33.120.235 Landscaped Areas

- A. Purpose.** The standards for landscaped areas are intended to enhance the overall appearance of residential developments and institutional campuses in multi-dwelling zones. The landscaping improves the residential character of the area, breaks up large expanses of paved areas and structures, provides privacy to the residents, and provides separation from streets. Landscaping also helps cool the air temperature, intercept rainfall and reduce stormwater run-off by providing a non-paved permeable surface. Landscaping can also provide food for people and habitat for birds and other wildlife.
- B. Minimum landscaped areas.** The required amount of landscaped area is stated in Table 120-3. Sites developed with a house, attached house, duplex, or manufactured dwelling park are exempt from this standard. Any required landscaping, such as for required setbacks or parking lots, applies toward the minimum required landscaped area.
1. Except as allowed by Paragraph B.2., required landscaped areas must:
 - a. Be at ground level or in raised planters that are used to meet minimum Bureau of Environmental Services stormwater management requirements; and
 - b. Comply with at least the L1 standard described in Chapter 33.248, Landscaping and Screening. However, up to one-third of the required landscaped area may be improved for active or passive recreational use or for use by pedestrians. Examples of active or passive recreational use include walkways, play areas, plazas, picnic areas, garden plots, and unenclosed recreational facilities.

2. Urban green alternative landscaped area. One or more of the following may be used to meet up to 50 percent of the required landscaped area:
 - a. Ecoroof. An ecoroof area may apply toward meeting the required landscaped area standard at a ratio of 4 square feet of ecoroof area for every 1 square foot of required landscaped area. The ecoroof area must be approved by the Bureau of Environmental Services as being in compliance with the Stormwater Management Manual.
 - b. Raised landscaped areas. Landscaped area raised above ground level may apply toward meeting the minimum landscaped area standard when landscaped to at least the L1 standard and soil depth is a minimum of 30 inches. Large trees are not allowed in raised landscaped area used to meet this alternative.

C. Additional landscaping standards.

1. Building setbacks. The required building setbacks must be landscaped to at least the L1 standard of Chapter 33.248, Landscaping and Screening. Ground-level pedestrian pathways, detached accessory structures and other development allowed in the setbacks are exempt from this standard except in the Eastern Pattern Area where allowed development can cover no more than 50 percent of the Eastern Pattern Area minimum rear setback area. Sites that are 10,000 square feet or less in total site area are also exempt from this standard.
2. Parking areas. Perimeter and internal parking area landscaping standards are stated in Chapter 33.266, Parking And Loading.

33.120.237 Trees

Requirements for street trees and for on-site tree preservation, protection, and overall tree density are specified in Title 11, Trees. See Chapter 11.50, Trees in Development Situations.

33.120.240 Required Outdoor and Common Areas

- A. Purpose.** The required outdoor and common area standards ensure opportunities for outdoor relaxation or recreation. The standards work with the building coverage and minimum landscaped areas standards to ensure that some of the land not covered by buildings is of adequate size, shape, and location to be usable for outdoor recreation or relaxation. The standards also ensure that outdoor areas are located so that residents have convenient access. Required outdoor areas are an important aspect in addressing the livability of a residential property by providing outdoor living opportunities, some options for outdoor privacy, and a healthy environment. These standards also allow for common area requirements to be met by indoor community facilities because they also provide opportunities for recreation and gathering.
- B. Outdoor area and common area requirements.** In the RM1 through RM4 zones, on sites with a residential use, both outdoor and common areas are required. Required common area may count toward required outdoor area, but individual private outdoor area may not count toward required common area. The standards of this section do not apply in the RX and RMP zones.

1. Required outdoor area. Outdoor area is required in the amounts stated below. Outdoor area may be provided as individual private outdoor area, such as a patio or balcony, or may be provided as common area, such as outdoor courtyards, outdoor play area, indoor recreational facilities, or indoor community rooms. There may be a combination of individual or common areas.
 - a. RM1 and RM2 zones. In the RM1 and RM2 zones, at least 48 square feet of outdoor area is required per dwelling unit.
 - b. RM3 and RM4 zones. In the RM3 and RM4 zones, on sites that are 20,000 square feet or less in total area, at least 36 square feet of outdoor area is required per dwelling unit. In the RM3 and RM4 zones, on sites that are more than 20,000 square feet in total area, at least 48 square feet of outdoor area is required per dwelling unit.
2. Required common area.
 - a. Required common area standard. On sites that are more than 20,000 square feet in total site area, and on sites with a congregate housing facility, at least 10 percent of total site area must be provided as common area. At least 50 percent of the required common area must be outdoor area, such as outdoor courtyards or outdoor play areas. Up to 50 percent of the required common area may be indoor common area, such as indoor recreation facilities or indoor community rooms.
 - b. Exemption. The required common area standard does not apply to sites where:
 - (1) All of the dwelling units have individual entrances that are within 20 feet of a street lot line;
 - (2) Each entrance is connected to the street by a path that is at least 3 feet wide and hard surfaced; and
 - (3) Each dwelling unit has at least 200 square feet of individual outdoor area with a minimum dimension of 10 feet by 10 feet.

C. Size, location and configuration.

1. Individual unit outdoor area. Where a separate outdoor area is provided for an individual unit, it must be designed so that a 4-foot x 6-foot square will fit entirely within it. The outdoor area must be directly accessible to the unit. Areas used for pedestrian circulation to more than one dwelling unit do not count towards meeting this standard of this subsection. If the area is at ground level, it may extend into the entire required side and rear setback. Individual unit outdoor areas located at ground level may also extend into the entire required street setback, but when located within a required street setback the outdoor area must either be at least 2 feet above the grade of the closest adjoining sidewalk or separated from the street lot line by a minimum 3 foot setback landscaped to at least the L2 standard described in Chapter 33.248, Landscaping and Screening. Covered outdoor areas are subject to Paragraph C.5 below.
2. Common areas.

- a. Outdoor common area. Where an outdoor, shared common area is provided, it must be designed so that it is at least 500 square feet in area and must measure at least 20 feet in all directions. The outdoor common area must be located within 20 feet of a building entrance providing access to residential units.
 - b. Indoor common area. Where an indoor common area is provided, it must be an indoor recreational facility or an indoor tenant community room. Indoor common areas that are not recreational facilities or community rooms, such as lobbies, hallways, laundry facilities, storage rooms, and vehicle or bicycle facilities, cannot be used to meet this requirement.
 - c. Combination of individual and common areas. Where a combination of individual unit and common areas is provided, each individual area must meet C.1 above and each common area must meet C.2.a or C.2.b above, providing an amount equivalent to the total required by Paragraph B.1 or B.2.
3. Surfacing materials. Required outdoor areas must be surfaced with lawn, pavers, decking, or sport court paving which allows the area to be used for active or passive recreational use.
 4. User amenities. User amenities, such as tables, benches, trees, shrubs, planter boxes, garden plots, drinking fountains, spas, or pools, may be placed in the outdoor area. Common, shared outdoor areas may also be developed with amenities such as play areas, plazas, roof-top patios, picnic areas, and open recreational facilities.
 5. Enclosure. Outdoor areas used to meet the requirements of this section may be covered, such as a covered patio, but they may not be fully enclosed. Covered outdoor areas are subject to the setback standards of this chapter.

33.120.250 Screening

- A. **Purpose.** The screening standards address specific unsightly features which detract from the appearance of multi-dwelling residential areas.
- B. **Garbage and recycling collection areas.** All exterior garbage cans, garbage collection areas, and recycling collection areas must be screened from the street and any adjacent properties. Trash receptacles for pedestrian use are exempt. Screening must comply with at least the L3 or F2 standards of Chapter 33.248, Landscaping and Screening.
- C. **Mechanical equipment.** Mechanical equipment located on the ground, such as heating or cooling equipment, pumps, or generators must be screened from the street and any abutting residential zones by walls, fences, or vegetation. Screening must comply with at least the L2 or F2 standards of Chapter 33.248, Landscaping and Screening, and be tall enough to screen the equipment. Mechanical equipment placed on roofs must be screened in one of the following ways, if the equipment is within 50 feet of an R zone:
 1. A parapet along facades facing the R zone that is as tall as the tallest part of the equipment;
 2. A screen around the equipment that is as tall as the tallest part of the equipment; or
 3. The equipment is set back from roof edges facing the R zone 3 feet for each foot of height of the equipment.

- D. Other screening requirements.** Outdoor seating associated with a Retail Sales And Service use must be screened from any abutting residential zones by walls, fences or vegetation. Screening must comply with at least the L3 or F2 standards of Chapter 33.248, Landscaping and Screening. The screening requirements for parking, exterior storage, and exterior display areas are stated with the regulations for those types of development.

33.120.255 Pedestrian Standards

- A. Purpose.** The pedestrian standards encourage a safe, attractive, and usable pedestrian circulation system in all developments. They ensure a direct pedestrian connection between abutting streets and buildings on the site, and between buildings and other activities within the site. In addition, they provide for connections between adjacent sites, where feasible. The standards promote configurations that minimize conflicts between pedestrians and vehicles. In order to facilitate additional pedestrian oriented space and less impervious surface, the standards also provide opportunities for accessways with low traffic volumes, serving a limited number of residential units, to be designed to accommodate pedestrians and vehicles within the same space when special paving treatments are used to signify their intended use by pedestrians as well as vehicles.
- B. The standards.** The standards of this section apply to all development except houses, attached houses, manufactured homes on individual lots, duplexes, and attached duplexes. The standards of this section also do not apply to manufactured dwelling parks. An on-site pedestrian circulation system must be provided. The system must meet all standards of this subsection.
1. Connections. The on-site pedestrian circulation system must provide connections as specified below:
 - a. Connection between streets and entrances.
 - (1) Sites with one street frontage.
 - Generally. All primary buildings located within 40 feet of a street lot line must have a connection between one main entrance and the adjacent street. The connection may not be more than 20 feet longer or 120 percent of the straight line distance, whichever is less.
 - Tree preservation. If a tree that is at least 12 inches in diameter is proposed for preservation, and the location of the tree or its root protection zone would prevent the standard of this paragraph from being met, the connection may be up to 200 percent of the straight line distance.
 - (2) Sites with more than one street frontage. Where the site has more than one street frontage, the following must be met:
 - The standard of B.1.a(1) must be met to connect the main entrance of each building located within 40 feet of a street lot line to the closest sidewalk or roadway if there are no sidewalks.
 - An additional connection, which does not have to be a straight line connection, is required between each of the other streets and a pedestrian entrance. However, if at least 50 percent of a street facing

facade is within 10 feet of the street, no connection is required to that street.

- b. Internal connections. On sites larger than 10,000 square feet, an internal pedestrian connection system must be provided. The system must connect all main entrances on the site that are more than 20 feet from the street, and provide connections to other areas of the site, such as parking areas, bicycle parking, recreational areas, common outdoor areas, and any pedestrian amenities.
2. Materials.
 - a. The circulation system required by the standards of this section must be hard-surfaced and must meet the following minimum width requirements:
 - (1) The circulation system on sites with up to 4 residential units must be at least 3 feet wide.
 - (2) The circulation system on sites with 5 to 20 units must be at least 4 feet wide.
 - (3) The circulation system on sites with more than 20 residential units must be at least 5 feet wide.
 - (4) Segments of the circulation system that connect only to an entrance providing access to up to 4 units may be 3 feet wide.
 - b. Except as allowed in subparagraph d, below, where the system crosses driveways, parking areas, and loading areas, the system must be clearly identifiable, through the use of elevation changes, speed bumps, a different paving material, or other similar method. Striping does not meet this requirement. Elevation changes and speed bumps must be at least 4 inches high.
 - c. Except as allowed in subparagraph d, below, where the system is parallel and adjacent to an auto travel lane, the system must be a raised path or be separated from the auto travel lane by a raised curb, bollards, landscaping or other physical barrier. If a raised path is used it must be at least 4 inches high and the ends of the raised portions must be equipped with curb ramps. Bollard spacing must be no further apart than 5 feet on center.
 - d. The pedestrian circulation system may be within an auto travel lane if the auto travel lane provides access to 16 or fewer parking spaces and the entire auto travel lane is surfaced with paving blocks or bricks.
 3. Lighting. The on-site pedestrian circulation system must be lighted to a level where the system can be used at night by the employees, residents, and customers.

33.120.260 Recycling Areas

Requirements for recycling areas are regulated by the Bureau of Planning and Sustainability. See Section 17.102.270, Businesses and Multifamily Complexes Required to Recycle, of the Portland City Code.

33.120.270 Alternative Development Options

- A. Purpose.** The alternative development options provide increased variety in development while maintaining the residential neighborhood character. The options are intended to:
- Accommodate a diversity of housing types and tenures;
 - Encourage development which is more sensitive to the environment, especially in hilly areas;
 - Encourage the preservation of open and natural areas;
 - Promote better site layout and opportunities for private recreational areas;
 - Allow for greater flexibility within a development site while limiting impacts to the surrounding neighborhood;
 - Promote more opportunities for affordable housing;
 - Allow more energy-efficient development;
 - Reduce the impact that new development may have on surrounding residential development;
 - Allow a greater sense of enclosure within common greens and shared courts; and
 - Ensure adequate open area within common greens.
- B. General requirements for all alternative development options.** The alternative development options listed in this section are allowed by right unless it is specifically stated otherwise. They must conform with all other development standards of the base zone unless those standards are superseded by the ones in this section. Sites in the RMP zone are not eligible for alternative development option.
- C. Attached houses.** The development standards for attached housing are:
1. Density, height, and other development standards. The minimum density, height, building length, landscaped areas, required outdoor area, and window requirements of the base zone apply.
 2. Lot size. See 33.612, Lots in Multi-Dwelling Zones, for lot size information.
 3. Building setbacks. The side building setback on the side containing the common or abutting wall is reduced to zero. The reduced setback applies to all buildings on the lot and extends along the full length of the lot line that contains the common or abutting wall.
 4. Building coverage. The maximum building coverage of the base zone applies to the entire attached housing project, however the maximum building coverage for an individual lot may not exceed 5 percent more than the base zone allowance.
 5. Maximum building length. The maximum building length standard stated in Table 120-3 applies to the combined length of the street-facing facades of each unit.
- D. Reduced setbacks for detached houses.** For land divisions that include lots created for detached houses, where the lots are at least 25 feet wide, the detached houses may have their side setbacks reduced to 3 feet on lot lines internal to the land division site. The reduced side setbacks must be shown on the land division Preliminary Plan. Eaves may project up to one foot into the reduced side setback. All building setbacks around the perimeter of the land division site are those of the base zone.

- E. Additional standards for attached houses, detached houses, and duplexes accessed by common greens, shared courts, or alleys.** These standards promote courtyard-oriented housing by facilitating the use of common greens and shared courts as part of housing projects on small sites. Standards within this section also promote pedestrian-oriented street frontages by facilitating the creation of rear alleys and allowing more efficient use of space above rear vehicle areas.
1. When these standards apply. These standards apply when the proposal includes a common green, shared court, or alley;
 2. Minimum density in RM1 and RM2 zones. The minimum density in the RM1 zone is 1 unit per 3,000 square feet. The minimum density in the RM2 zone is 1 unit per 2,000 square feet;
 3. Accessory structures.
 - a. Covered accessory structures for the common use of residents are allowed within common greens and shared courts. Covered accessory structures include gazebos, garden structures, greenhouses, picnic areas, play structures and bike parking areas;
 - b. Structures for recycling or waste disposal are allowed within common greens, shared courts, private alleys, or parked tracts;
 4. Setbacks.
 - a. The front and side minimum building setbacks from common greens and shared courts are reduced to 3 feet; and
 - (1) Minor architectural features such as eaves, awnings, and trellises are allowed in this setback; and
 - (2) On corner lots where there is one street lot line on a public street and one street lot line is on the common green or shared court, up to 30 percent of the area of the building facade facing the common green or shared court may extend into this setback. At least 30 percent of the area extending into this setback must include windows or glass block. Porches are exempt from the window standard.
 - b. The setbacks of garage entrances accessed from a shared court must be either 5 feet or closer to the shared court property line, or 18 feet or further from the shared court property line. If the garage entrance is located within 5 feet of the shared court property line, it may not be closer to the property line than the residential portion of the building.
 - c. For accessory structures in common greens, shared courts, private alleys, or parking tracts, the setbacks are:
 - (1) Adjacent to a public street. The minimum setback from a public street is 10 feet;
 - (2) Setback from project perimeter. If the common green, shared court, private alley, or parking tract abuts the perimeter property line of the project, the

minimum setback for the accessory structure is 5 feet. The perimeter property line of the project is the boundary of the site before development;

- (3) Setback from all other lot lines. The minimum setback from all other lot lines is 3 feet;
5. Maximum height. Accessory structures in common greens, shared courts, private alleys, or parking tracts may be up to 15 feet high.
6. Building coverage.
 - a. When a land division proposal includes common greens, shared courts, or private alleys, maximum building coverage is calculated based on the entire land division site, rather than for each lot.
 - (1) Buildings or structures in common greens, shared courts, private alleys, or parking tracts are included in the calculation for building coverage for the land division site;
 - (2) The combined building coverage of all buildings and structures in common greens or shared courts may not exceed 15 percent of the total area of the common greens or shared courts.
 - (3) Any amount of building coverage remaining from the calculation for the area of the common green, shared court, alley, or parking tract will be allocated evenly to all of the lots within the land division, unless a different allocation of the building is approved through the land division decision. The building coverage allocated to the lots will be in addition to the maximum allowed for each lot.
 - b. For attached houses, uncovered rear balconies that extend over an alley or vehicle maneuvering area between the house and rear lot line do not count toward maximum building coverage calculations.
7. Garages fronting onto shared courts. For garages accessory to houses or detached houses that are less than 24 feet wide that front onto shared courts, the length of the garage wall facing the shared court may be up to 12 feet long if there is interior living area above the garage. The living area must be set back no more than 4 feet from the garage wall facing the shared court.
- F. Attached duplexes.** The attached duplex regulations allow for an alternative housing type that promotes owner-occupied structures, the efficient use of land, and for energy-conserving housing.
 1. Lot size. Each attached duplex must be on a lot that complies with the lot size standard for new lots of the base zone.
 2. Building setbacks. The side building setback on the side containing the common wall is reduced to zero.
 3. Number of units. A maximum of 2 units per lot and 4 units per structure is allowed.
- G. Planned Development.** See Chapter 33.638, Planned Development.

33.120.275 Development Standards for Institutions

- A. Purpose.** The general base zone development standards in the multi-dwelling zones are designed for residential buildings. Different development standards are needed for institutional uses which may be allowed in multi-dwelling zones. The intent is to maintain compatibility with and limit the negative impacts on surrounding residential areas.
- B. Use categories to which these standards apply.** Except for Daycare uses, the standards of this section apply to uses in the institutional group of use categories in the multi-dwelling zones, whether allowed by right, allowed with limitations, or subject to a conditional use review. Daycare uses are subject to the regular base zone development standards. The standards of this section apply to new development, exterior alterations, and conversions to institutional uses. Recreational fields used for organized sports on a school, school site, or in a park, are subject to the regulations of Chapter 33.279, Recreational Fields for Organized Sports.
- C. The standards.**
1. The development standards are stated in Table 120-7. If not addressed in this section, the regular base zone development standards apply.
 2. Setbacks on a transit street or in a Pedestrian District. If the minimum setback conflicts with the maximum setback, the maximum setback supersedes the minimum.
 3. Exterior storage. Exterior storage of materials or equipment is prohibited.
 4. Outdoor activity facilities. Except as specified in paragraph C.5, below, outdoor activity facilities, such as swimming pools, basketball courts, tennis courts, or baseball diamonds must be set back 50 feet from abutting R-zoned properties. Playground facilities must be set back 25 feet from abutting R-zoned properties if not illuminated, and 50 feet if illuminated.
 5. Recreational fields used for organized sports. Recreational fields used for organized sports on a school, school site, or in a park, are subject to Chapter 33.279, Recreational Fields for Organized Sports.
 6. Electrical substations. In addition to the standards in Table 120-7, the entire perimeter of electrical substations, including the street lot line (except for the access point), must be landscaped to the L3 standards stated in Chapter 33.248. This landscaping must be planted on the outside of any security fence. Electrical substations that are in a fully enclosed building are exempt from this requirement.
 7. Grassy areas. Grassy play areas, golf courses, cemeteries, and natural areas are not subject to the high hedge buffering standard and are exempt from the setback standard of Paragraph C.2, above.
 8. Access for accessory Retail Sales And Service Uses. Areas occupied by an accessory Retail Sales And Service use may have no direct access to the outside of the building. Access to the area must be from an interior space or from an exterior space that is at least 150 feet from a public right-of-way.
 9. Exterior signage for accessory Retail Sales And Service uses is prohibited.

Table 120-7 Institutional Development Standards [1]	
Minimum Site Area for New Uses	10,000 sq. ft.
Maximum Floor Area Ratio [2]	2 to 1
Maximum Height [3]	75 ft.
Minimum Building Setbacks [2]	1 ft. back for every 2 ft. of bldg. height, but in no case less than 10 ft.
Maximum Building Coverage [2]	70% of site area
Minimum Landscaped Area [2,4]	20% of site area
Buffering from Abutting Residential Zone [5]	10 ft. to L3 standard
Buffering Across a Street from a Residential Zone [5]	10 ft. to L1 standard
Setbacks for All Detached Accessory Structures Except Fences	10 ft.
Parking and Loading	See Chapter 33.266, Parking And Loading
Signs	See Title 32, Signs and Related Regulations

Notes:

[1] The standards of this table are minimums or maximums as indicated. Compliance with the conditional use approval criteria might preclude development to the maximum intensity permitted by these standards.

[2] For campus-type developments, the entire campus is treated as one site. Setbacks are only measured from the perimeter of the site. The setbacks in this table only supersede the setbacks required in Table 120-3. The normal regulations for projections into setbacks and for detached accessory structures still apply.

[3] Towers and spires with a footprint of 200 square feet or less may exceed the height limit, but still must comply with the setback standard.

[4] Any required landscaping, such as for required setbacks or parking lots, applies towards the landscaped area standard.

[5] Vehicle areas are subject to the parking lot setback and landscaping standards stated in Chapter 33.266, Parking, Loading, and Transportation and Parking Demand Management.

33.120.280 Detached Accessory Structures

A. Purpose. This section regulates detached structures that are incidental to primary buildings to prevent them from becoming the predominant element of the site. The standards limit the height and bulk of the structures and promote compatibility of design for larger accessory structures when they are in conjunction with single-dwelling development. The standards provide for necessary access around structures, help maintain privacy to abutting lots, provide flexibility for the location of accessory structures, and maintain open front yard areas.

B. General standards.

1. The regulations of this section apply to all accessory structures. Additional regulations for accessory dwelling units are stated in Chapter 33.205.
2. Detached accessory structures are allowed on a site only in conjunction with a primary building and may not exist on a site prior to the construction of the primary structure, except as allowed by Paragraph B.3, below.
3. A detached accessory structure that becomes the only structure on a lot as the result of a land division, a property line adjustment, a lot confirmation, or a demolition of the primary structure may remain on the lot if the owner has executed a covenant with the City that meets the requirements of Section 33.700.060.

- a. For a land division, the covenant must require the owner to remove the accessory structure if, within two years of final plat approval, a primary structure has not been built and received final inspection. The covenant must be executed with the City prior to final plat approval.
 - b. For a property line adjustment or a lot confirmation, the covenant must require the owner to remove the accessory structure if a primary structure has not been built and received final inspection within two years. The two years begins on the date the letter from BDS approving the property line adjustment or lot confirmation is mailed. The covenant must be executed with the City before the final letter from BDS is issued.
 - c. For a demolition of a primary structure, the covenant must require the owner to remove the accessory structure if a new primary structure has not been built and received final inspection within two years of the demolition of the old primary structure. The two years begins on the date of the final inspection of the demolition. The covenant must be executed with the City prior to the issuance of the demolition permit.
- C. Detached covered accessory structures.** Detached covered accessory structures are items such as garages, greenhouse, artist's studios, guest houses, accessory dwelling units, laundry or community buildings, storage buildings, covered bicycle parking, wood sheds, water collection cisterns, and covered decks or patios. The following standards apply to all detached covered accessory buildings. Garages are also subject to the standards of 33.120.283.
1. Height. In general, the height standard of the base zone apply to detached covered accessory structures. The maximum height allowed for detached covered structures that are accessory to a house, attached house, duplex, attached duplex or manufactured home on an individual lot is 20 feet.
 2. Setbacks. Except as follows, detached covered accessory structures are subject to required building setbacks. See the additional regulations for garages in 33.120.283.
 - a. Water collection cisterns that are 6 feet or less in height are allowed in side and rear setbacks.
 - b. Detached covered accessory structures are allowed in the side and rear building setbacks, if all of the following are met:
 - (1) The structure is at least 10 feet from a street lot line or no closer to a street line than the closest primary building, whichever distance is greater;
 - (2) The structure's footprint has dimensions that do not exceed 24 feet by 24 feet, excluding eaves;
 - (3) If more than one structure is within the setback, the combined length of all structures in the setback adjacent to each property line is no more than 24 feet;

- (4) The structure is no more than 15 feet high, and the walls of the structure are no more than 10 feet high, excluding the portion of the wall within a gable;
 - (5) The portion of the structure within the setback must be screened from adjoining lots by a fence or landscaping, unless it is enclosed within the setback by a wall. Screening is not required for enclosed structures. Screening must comply with the L3 or F2 standards of Chapter 33.248, Landscaping and Screening;
 - (6) Walls located within the setback may not have doors or windows facing the adjacent lot line;
 - (7) The structure does not have a rooftop deck; and
 - (8) Dormers are set back at least 5 feet from the side and rear lot lines that abut another lot.
3. Building coverage. The following additional building coverage standards apply to detached covered accessory structures.
 - a. The combined building coverage of all detached covered accessory structures may not exceed 15 percent of the total area of the site.
 - b. The building coverage of a detached covered accessory structure may not be greater than the building coverage of the primary structure.
 4. Additional development standards for detached covered accessory structures. The following additional standards apply to detached covered accessory structures that are more than 15 feet high, and are accessory to houses, attached houses, duplexes, attached duplexes, manufactured homes, triplexes, or fourplexes on individual lots. Additions to existing structures that do not meet a standard are exempt from that standard.
 - a. Exterior Finish Materials. The exterior finish materials on the detached covered accessory structure must meet one of the following:
 - (1) The exterior finish material must be the same or visually match in type, size and placement, the exterior finish material of the primary structure; or
 - (2) Siding must be made from wood, composite boards, vinyl or aluminum products, and the siding must be composed in a shingle pattern, or in a horizontal clapboard or shiplap pattern. The boards in the pattern must be 6 inches or less in width.
 - b. Roof Pitch. The pitch of the roof with the highest ridgeline on the detached covered accessory structure must meet one of the following:
 - (1) The pitch of the roof with the highest ridgeline must be the same as the pitch of the roof with the highest ridgeline of the primary structure; or
 - (2) The pitch of the roof with the highest ridgeline must be at least 6/12.

- c. Trim. The trim on the detached covered accessory structure must meet one of the following:
 - (1) The trim must be the same in type, size, and location as the trim used on the primary structure; or
 - (2) The trim around all windows and doors must be at least 3 ½ inches wide.
- d. Windows. The windows on all street facing facades of the detached covered accessory structure must meet one of the following:
 - (1) The windows must match those on the street facing façade of the primary structure in orientation (horizontal or vertical); or
 - (2) Each window must be square or vertical – at least as tall as it is wide.
- e. Eaves. The eaves on the detached covered accessory structure must meet one of the following:
 - (1) The eaves must project from the building walls the same distance as the eaves on the primary structure;
 - (2) The eaves must project from the building walls at least 1 foot on all elevations; or
 - (3) If the primary structure has no eaves, no eaves are required.

D. Detached uncovered vertical structures. Vertical structures are items such as flag poles, trellises, arbors, and other garden structures, play structures, antennas, satellite receiving dishes, and lamp posts. The following standards apply to uncovered vertical structures. Fences are addressed in Section 33.120.285 below:

- 1. Height. Except as follows, the maximum height allowed for all detached uncovered vertical structures is the maximum height of the base zone. The maximum height allowed for detached uncovered vertical structures that are accessory to a house, attached house, duplex, attached duplex or manufactured home on an individual lot is 20 feet:
 - a. Antennas, utility power poles, and public safety facilities are exempt from height limits.
 - b. Flagpoles are subject to the height limit of the base zone for primary structures.
 - c. Detached small wind turbines are subject to the standards of 33.299.
- 2. Setbacks. Except as follows, detached uncovered vertical structures are subject to the required building setbacks:
 - a. Detached uncovered vertical structures that are no larger than 3 feet in width, depth, or diameter and no taller than 8 feet are allowed in required building setback.
 - b. A single arbor structure that is up to 6 feet wide, up to 3 feet deep, and up to 8 feet tall is allowed in a front setback. The arbor must allow for pedestrian access under its span.

- c. Flagpoles are allowed in required building setbacks.
- d. Detached uncovered vertical structures that exceed the allowances of Subparagraph 2.a are allowed in side and rear setbacks if all of the following are met:
 - (1) The structure is at least 40 feet from a front lot line, and if on a corner lot, at least 20 feet from a side street lot line;
 - (2) The structure's footprint has dimensions that do not exceed 24 feet by 24 feet; and
 - (3) The structure is no more than 10 feet high;
 - (4) The portion of the structure within the setback must be screened from adjoining lots by a fence or landscaping, unless it is enclosed within the setback by a wall. Screening is not required for enclosed structures. Screening must comply with the L3 or F2 standards of Chapter 33.248, Landscaping and Screening; and
 - (5) The structure does not have a rooftop deck.

E. Detached uncovered horizontal structures. Uncovered horizontal structures are items such as decks, stairways, swimming pools, hot tubs, tennis courts, and boat docks not covered or enclosed. The following standards apply to detached uncovered horizontal structures:

- 1. Height. In general, the maximum height allowed for detached uncovered vertical structures is the maximum height of the base zone. The maximum height allowed for detached uncovered vertical structures that are accessory to a house, attached house, duplex, attached duplex or manufactured home on an individual lot is 20 feet.
- 2. Setbacks. Except as follows, detached uncovered horizontal structures are subject to the required building setbacks:
 - a. Detached uncovered decks, ramps, and stairways that are more than 2-1/2 feet above the ground may extend into a required building setback up to 20 percent of the depth of the setback. However, the deck or stairway must be at least three feet from a lot line.
 - b. Structures that are no more than 2-1/2 feet above the ground are allowed in all building setbacks.

F. Detached mechanical equipment. Mechanical equipment includes items such as heat pumps, air conditioners, emergency generators, radon mitigation components, and water pumps. Generally, detached mechanical equipment will not be attached to the building but may have components such as ventilation or electrical systems attached to the primary structure. The following standards apply to detached mechanical equipment:

- 1. Height. In general, the maximum height allowed for detached mechanical equipment is the maximum height of the base zone. The maximum height allowed for detached mechanical equipment that is accessory to a house, attached house, duplex, attached duplex or manufactured home on an individual lot is 20 feet.

2. Setbacks. Except as follows, detached mechanical equipment is subject to required building setbacks. Detached mechanical equipment accessory to a house, attached house, duplex, attached duplex, manufactured home, triplex, or fourplex on an individual lot is allowed in side or rear building setbacks if all of the following are met:
 - a. The equipment is no more than five feet high; and
 - b. The equipment is screened from adjoining lots by walls, fences or vegetation. Screening must comply with the L3 or F2 standards of Chapter 33.248, Landscaping and Screening.

33.120.283 Additional Development Standards for Structured Parking and Garages

A. Purpose. These standards:

- Together with the window and main entrance standards, ensure that there is a physical and visual connection between the living area of residential buildings and the street;
- Ensure that the location and amount of the living areas of residential buildings, as seen from the street, are more prominent than structured parking or garages;
- Prevent structured parking and garages from obscuring the main entrance from the street and ensure that the main entrance for pedestrians, rather than automobiles, is the prominent entrance;
- Provide for a more pleasant pedestrian environment by preventing structured parking and garages from dominating the views of the neighborhood from the sidewalk; and
- Enhance public safety by preventing structured parking and garages from blocking views of the street from inside the residence.

B. Additional regulations. The regulations of this Section apply in addition to those of 33.120.280, Accessory Structures.

C. Existing detached garages.

1. Rebuilding. A detached garage that is nonconforming due to its location in a setback may be rebuilt on the footprint of the existing foundation, if the garage was originally constructed legally. In this case, the rebuilt garage may be no more than 15 feet high, and the garage walls may be no more than 10 feet high, excluding the portion of the wall within a gable. Decks are not allowed on the roof of the garage. The rebuilt garage is not required to comply with other standards of this chapter.
2. Additions. An addition may be made to an existing detached garage that is nonconforming due to its location in a setback as follows:
 - a. The expanded garage meets all other standards of this chapter; or
 - b. The combined size of the existing foundation and the addition is no larger than 12 feet wide by 20 feet deep. In this case, the garage is no more than 15 feet high, and the walls of the addition may be no more than 10 feet high, excluding the portion of the wall within a gable. Decks are not allowed on the roof of the garage. The expanded garage is not required to comply with other standards of this chapter.

D. Length of street-facing garage or structure parking wall.

1. Where these regulations apply. The regulations of this subsection apply to structured parking and garages in multi-dwelling zones. Where a proposal is for an alteration or addition to existing development, the standard applies only to the portion being altered or added.
2. Exemptions.
 - a. Development on flag lots and development on lots that slope up or down from the street with an average slope of 20 percent or more are exempt from the standard of this Subsection.
 - b. Garages and structured parking that are located more than 40 feet from a street lot line and sites where all parking access is from a shared court are exempt from the standards of this Subsection.
 - c. Subdivisions and PUDs that received preliminary plan approval between September 9, 1990, and September 9, 1995, are exempt from the standard of this subsection.
 - d. Structured parking where the elevation of the floor is 4 feet or more below the lowest elevation of an adjacent right-of-way is exempt from the standards of this Subsection.
 - e. On corner lots:
 - (1) Garages. On corner lots, only one street-facing garage wall that contains the garage door must meet the standards of this Subsection.
 - (2) Structured parking. On corner lots, only one street-facing facade of a building with structured parking must meet the standards of this Subsection. For sites with more than one street frontage, the standards of this Subsection must be met along the street with the highest transit street classification. If two or more streets have the same highest transit street classification, then the standards must be met on the longest street-facing façade located within 40 feet of a street lot line. If two or more streets have the same highest transit street classification and the street-facing facades are the same length, the applicant may choose on which of those streets to meet the standards.
3. Standards.
 - a. Garages that are accessory to houses. For garages that are accessory to houses or manufactured homes, the length of the garage wall facing the street may be up to 50 percent of the length of the street-facing building facade. See Figure 120-13. Where the street-facing facade is less than 22 feet long, an attached garage is not allowed as part of that facade.
 - b. Garages that are accessory to attached houses. The following standards apply to garages that are accessory to attached houses and attached duplexes:

- (1) The length of the garage wall facing the street may be up to 50 percent of the length of the street facing building façade. See Figure 120-12. When all the units are 22 feet wide or wider, the standard applies to the street-facing façade of each unit. In all other situations, the standard applies to the total length of the street-facing facade; and
 - (2) When the attached house structure is made up of more than three attached houses and at least one attached house is less than 22 feet wide, at least 50 percent of the total length of the street-facing facade must be without garage, and the 50 percent length without garage must be contiguous. See Figure 120-14.
- c. Garages and structured parking that are accessory to all other residential structure types. The following standards apply to garages and structured parking that are accessory to all residential structure types:
- (1) The length of the garage or structured parking wall facing the street may be up to 50 percent of length of the street-facing building façade. See Figure 120-12. Where the length of the street-facing facade is less than 22 feet long, an attached garage and structured parking are not allowed; and
 - (2) For a fourplex or a multi-dwelling structure, at least 50 percent of the total length of the street-facing building facade must be without garage or structured parking, and the 50 percent length without garage or structured parking must be contiguous. See Figure 120-14.

E. Street lot line setbacks.

1. Where this standard applies. The standard of this paragraph applies to structured parking and garages in multi-dwelling zones. Where a proposal is for an alteration or addition to existing development, the standard applies only to the portion being altered or added.
2. Exemptions.
 - a. Development on flag lots or on lots that slope up or down from the street with an average slope of 20 percent or more are exempt from this standard.
 - b. Subdivisions and PUDs that received preliminary plan approval between September 9, 1990, and September 9, 1995, are exempt from this standard.
3. Standard. A structured parking or garage wall that faces a street may be no closer to the street lot line than the longest street-facing wall of the building. Where a lot has more than one street lot line, and there is an existing dwelling unit on the lot, this standard must be met only on the street-facing facade on which the main entrance is located. See Figure 120-15.
4. Exception. A street-facing garage wall may be up to 6 feet in front of the longest street-facing wall of the building, if:
 - a. The street-facing garage wall is 40 percent or less of the length of the building facade; and

- b. There is a porch at the main entrance. The garage wall may not be closer to the street lot line than the front of the porch. See Figure 120-16. The porch must meet the following:
- (1) The porch must be at least 48 square feet in area and have minimum dimensions of 6 feet by 6 feet;
 - (2) The porch must have a solid roof; and
 - (3) The roof may not be more than 12 feet above the floor of the porch.

Figure 120-13
Length of Street-Facing Garage Wall

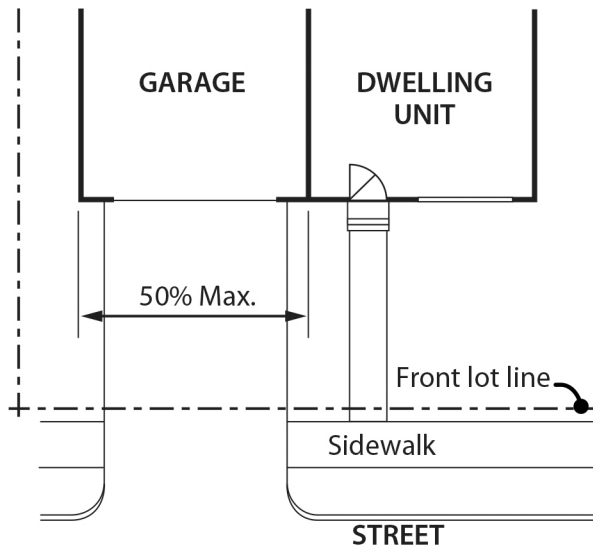

Figure 120-14
Combined Length of Street-Facing Garage Wall

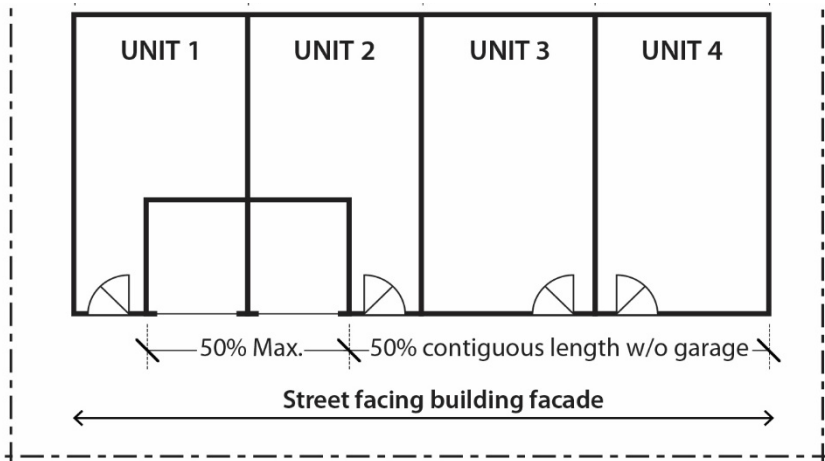

Figure 120-15
Street Lot Line Setback

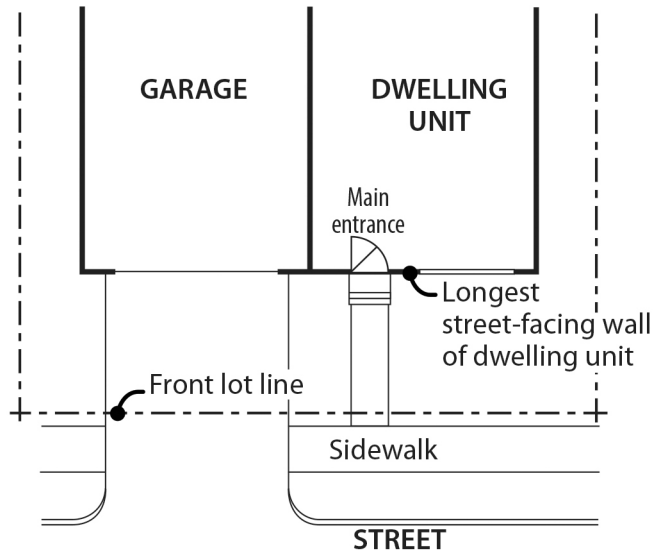
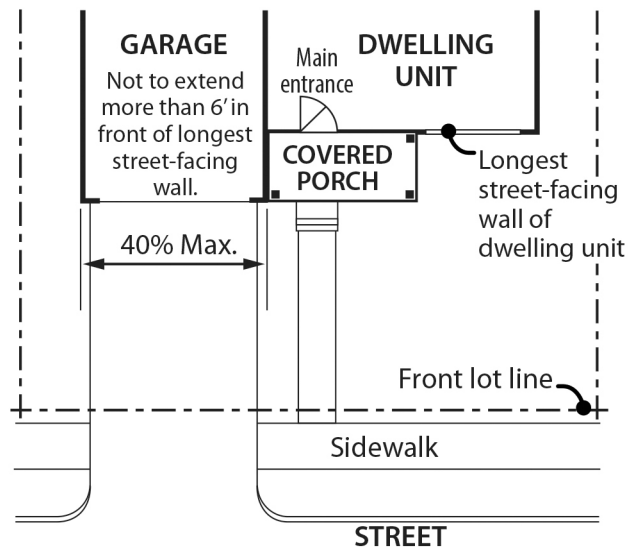

Figure 120-16
Garage Front Setback Exception



33.120.284 Additional Development Standards for Flag Lots

- A. Purpose.** These standards include required screening and setbacks to protect the privacy of abutting residences and increase the compatibility of new development on flag lots.
- B. Where these standards apply.** The additional standards of this section apply to flag lots in the multi-dwelling zones created before July 1, 2002.

C. Standards.

1. Setbacks. Flag lots have required building setbacks that are the same along all lot lines. The required setbacks are:

Zone	Setback
RM1, RM2, RM3, RM4	10 feet

2. Landscaped buffer area. In the RM1 through RM4 zones, on lots that are 10,000 square feet or less in area, a landscaped area is required around the perimeter of the flag lot to buffer the flag portion from surrounding lots. The pole and the lot line that separates the flag lot and the lot from which it was divided are exempt from this requirement. The landscaped area must be at least 3 feet deep and be landscaped to at least the L3 standard. See Figure 120-17.

**Figure 120-17
Flag Lot Description and Buffer**

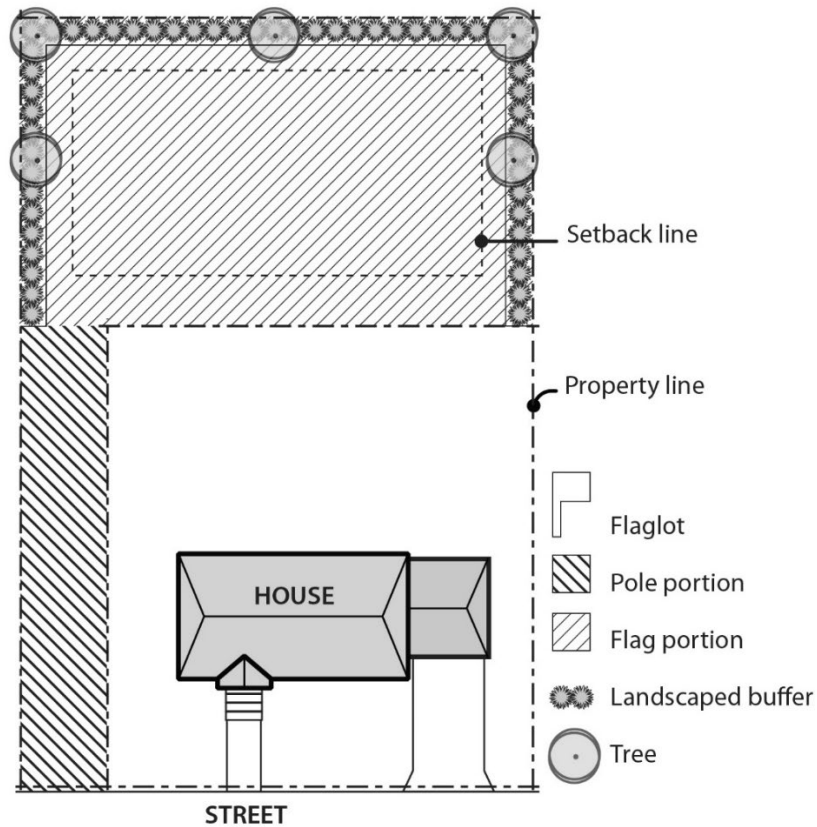

33.120.285 Fences

- A. Purpose.** The fence standards promote the positive benefits of fences without negatively impacting the community or endangering public or vehicle safety. Fences can create a sense of privacy, protect children and pets, provide separation from busy streets, and enhance the appearance of property by providing attractive landscape materials. The negative effects of fences can include the creation of street walls that inhibit police and

community surveillance, decrease the sense of community, hinder emergency access, lessen solar access, hinder the safe movement of pedestrians and vehicles, and create an unattractive appearance. These standards are intended to promote the positive aspects of fences and to limit the negative ones.

B. Types of fences. The standards apply to walls, fences, and screens of all types whether open, solid, wood, metal, wire, masonry, or other material.

C. Location and height.

1. House, attached house, duplex, attached duplex, and manufactured home. The following fence location and height standards apply to houses, attached houses, duplexes, attached duplexes, and manufactured homes:
 - a. Front building setbacks. Fences up to 3-1/2 feet high are allowed in a required front building setback, or within the first 5 feet of the front lot line, whichever is greater.
 - b. Side and rear building setback.
 - (1) Fences up to 8 feet high are allowed in required side or rear building setbacks that do not abut a pedestrian connection.
 - (2) Fences abutting a pedestrian connection.
 - Fences up to 8 feet high are allowed in required side or rear building setbacks that abut a pedestrian connection if the pedestrian connection is part of a right-of-way that is at least 30 feet wide.
 - Fences up to 3-1/2 feet high are allowed in required side or rear building setbacks that abut a pedestrian connection if the pedestrian connection is part of a right-of-way that is less than 30 feet wide.
 - c. Exception for corner lots. On corner lots, if the main entrance is on the facade facing the side street lot line, the applicant may elect to meet the following instead of Subparagraphs C.1.a. and C.1.b.:
 - (1) Fences up to 3-1/2 feet high are allowed within the first 10 feet of the side street lot line.
 - (2) Fences up to 3-1/2 feet high are allowed in required setbacks that abut a pedestrian connection if the pedestrian connection is part of a right-of-way that is less than 30 feet wide;
 - (3) Fences up to 8 feet high are allowed in the required front building setback, outside of the area subject to c(1).
 - (4) Fences up to 8 feet high are allowed in all other side or rear building setbacks.
 - d. Not in building setbacks. The height for fences that are not in required building setbacks is the same as the regular height limits of the zone.

2. All other development. The following fence location and height standards apply to development that is not a house, attached house, manufactured home, duplex or attached duplex:
 - a. Front building setbacks. Fences up to 3-1/2 feet high are allowed in a required front building setback, or within the first 5 feet of the front lot line, whichever is greater.
 - b. Side and rear building setbacks.
 - (1) Fences up to 3-1/2 feet high are allowed in required side building setbacks that abut a street.
 - (2) Fences abutting a pedestrian connection.
 - Fences up to 8 feet high are allowed in required side or rear building setbacks that abut a pedestrian connection if the pedestrian connection is part of a right-of-way that is at least 30 feet wide.
 - Fences up to 3-1/2 feet high are allowed in required side or rear building setbacks that abut a pedestrian connection if the pedestrian connection is part of a right-of-way that is less than 30 feet wide.
 - (3) Fences up to 8 feet high are allowed in required side or rear building setbacks that do not abut a street or a pedestrian connection.
 - c. Not in building setbacks. The height for fences that are not in required building setbacks is the same as the regular height limits of the zone.

- D. Reference to other regulations.** Electrified fences are regulated under Title 26, Electrical Regulations. The use of barbed wire is regulated under Title 24, Building Regulations.

33.120.290 Demolitions

- A. Generally.** Demolition on a site that requires a demolition permit is subject to the tree preservation and protection requirements of Title 11, Trees. See Chapter 11.50, Trees in Development Situations.
- B. Historic resources.** Demolition of historic resources is regulated by Chapter 33.445, Historic Resource Overlay Zone.

33.120.300 Nonconforming Development

Existing developments that do not conform to the development standards of this chapter may be subject to the regulations of Chapter 33.258, Nonconforming Situations.

33.120.305 Parking and Loading

The standards for the minimum required and maximum allowed number of auto parking spaces, required number of bike parking spaces, parking lot placement, parking lot setbacks and landscaping, loading areas and driveways are stated in Chapter 33.266, Parking And Loading.

33.120.310 Signs

The sign regulations are stated in Title 32, Signs and Related Regulations.

33.120.320 Inclusionary Housing

The regulations pertaining to inclusionary housing are stated in Chapter 33.245, Inclusionary Housing.

33.120.330 Street and Pedestrian Connections

A. Large site pedestrian connectivity.

1. Purpose. The large site pedestrian connectivity standard implements regional pedestrian and bicycle connectivity standards. The standard enhances direct movement by pedestrians and bicycles between destinations and increases the convenience of travelling by foot or bike. The standard also protects public health and safety by ensuring safe movement and access through a large site. The standard provides flexibility for locating the pedestrian connection in a manner that addresses site constraints such as existing development.
2. When does the standard apply. The large site pedestrian connectivity standard applies to new development and major remodeling on sites that are more than 5 acres in size.
3. Standard. If the site does not have pedestrian connections at least every 330 feet as measured from the centerline of each connection, then dedication of right-of-way for pedestrian connections is required.
4. Exemptions. Dedication of right-of-way for pedestrian connections is not required in:
 - a. The Central City plan district; and
 - b. Areas of a site that are in the Environmental Protection overlay zone, the Environmental Conservation overlay zone, or have slopes with an average slope of 20 percent or greater. This means that if the 330 feet interval falls in one of these areas, that pedestrian connection is not required.
5. Pedestrian connection alignment, width and design. The Bureau of Transportation must approve the alignment of the pedestrian connections. The final alignment must ensure that pedestrian connections are located at least 200 feet apart. The Bureau of Transportation must also approve the width of, and configuration of elements within, the pedestrian connections.

- B.** Additional requirements for street and pedestrian/bicycle connections are regulated by the Bureau of Transportation. See Section 17.88.040, Through Streets, of the Portland City Code.

(Amended by: Ord. No. 165376, effective 5/29/92; Ord. No. 165594, effective 7/8/92; Ord. No. 166313, effective 4/9/93; Ord. No. 166702, effective 7/30/93; Ord. No. 167054, effective 10/25/93; Ord. No. 167186, effective 12/31/93; Ord. No. 167189, effective 1/14/94; Ord. No. 168698, effective 4/17/95; Ord. No. 169535, effective 1/8/96; Ord. No. 169699, effective 2/7/96; Ord. No. 169987, effective 7/1/96; Ord. No. 170704, effective 1/1/97; Ord. No. 171081, effective 5/16/97; Ord. No. 171219, effective 7/1/97; Ord. No. 171718, effective 11/29/97; Ord. No. 171879, effective 2/2/98; Ord. No. 173533, effective 8/2/99; Ord. No. 173593, effective 9/3/99; Ord. No. 173729, effective 9/8/99; Ord. No. 174263, effective 4/15/00; Ord. No. 174378, effective 5/26/00; Ord. No. 174980,

effective 11/20/00; Ord. No. 175204, effective 3/1/01; Ord. No. 175837, effective 9/7/01; Ord. No. 175966, effective 10/26/01; Ord. No. 176193, effective 2/1/02; Ord. Nos. 175965 and 176333, effective 7/1/02; Ord. No. 176469, effective 7/1/02; Ord. No. 177028, effective 12/14/02; Ord. No. 177422, effective 6/7/03; Ord. No. 177920, effective 11/8/03; Ord. No. 178423, effective 6/18/04; Ord. No. 178509, effective 7/16/04; Ord. No. 178657, effective 9/3/04; Ord. No. 178832, effective 10/21/04; Ord. No. 178927, effective 12/31/04; Ord. No. 179845, effective 1/20/06; Ord. Nos. 179980 and 179994, effective 4/22/06; Ord. No. 180619, effective 12/22/06; Ord. No. 181357, effective 11/9/07; Ord. No. 182072, effective 8/22/08; Ord. No. 182429, effective 1/16/09; Ord. No. 183269, effective 10/21/09; Ord. No. 183598, effective 4/24/10; No. 183750, effective 6/4/10; Ord. No. 184016, effective 08/20/10; Ord. No. 184524, effective 7/1/11; Ord. No. 185412, effective 6/13/12; No. 185915, effective 5/1/13; Ord. No. 186639, effective 7/11/14; Ord. No. 186736, effective 08/28/14; Ord. No. 186053, effective 1/1/15; Ord. No. 187216, effective 7/24/15; Ord. No. 187471, effective 1/1/16; Ord. No. 188077, effective 12/9/16; Ord. No. 188142, effective 1/13/17; Ord. No. 188162, effective 2/1/17; Ord. No. 188259, effective 3/31/17; Ord. No. 188177, effective 5/24/18; Ord. No. 188958, effective 5/24/18; Ord. No. 189000, effective 7/9/18; Ord. No. 189137, effective 8/22/18; Ord. No. 189488, effective 12/2/19; Ord. No. 189807, effective 12/18/19; Ord. No. 189805, effective 3/1/20; Ord. No. 189784, effective 3/1/20; Ord. No. 190023, effective 8/10/20 and 8/1/21; Ord. No. 190380, effective 4/30/21 and 8/1/21; Ord. No. 190687, effective 3/1/22.)

Civic and Neighborhood Corridors

Map 120-1

Map Revised June 18, 2020

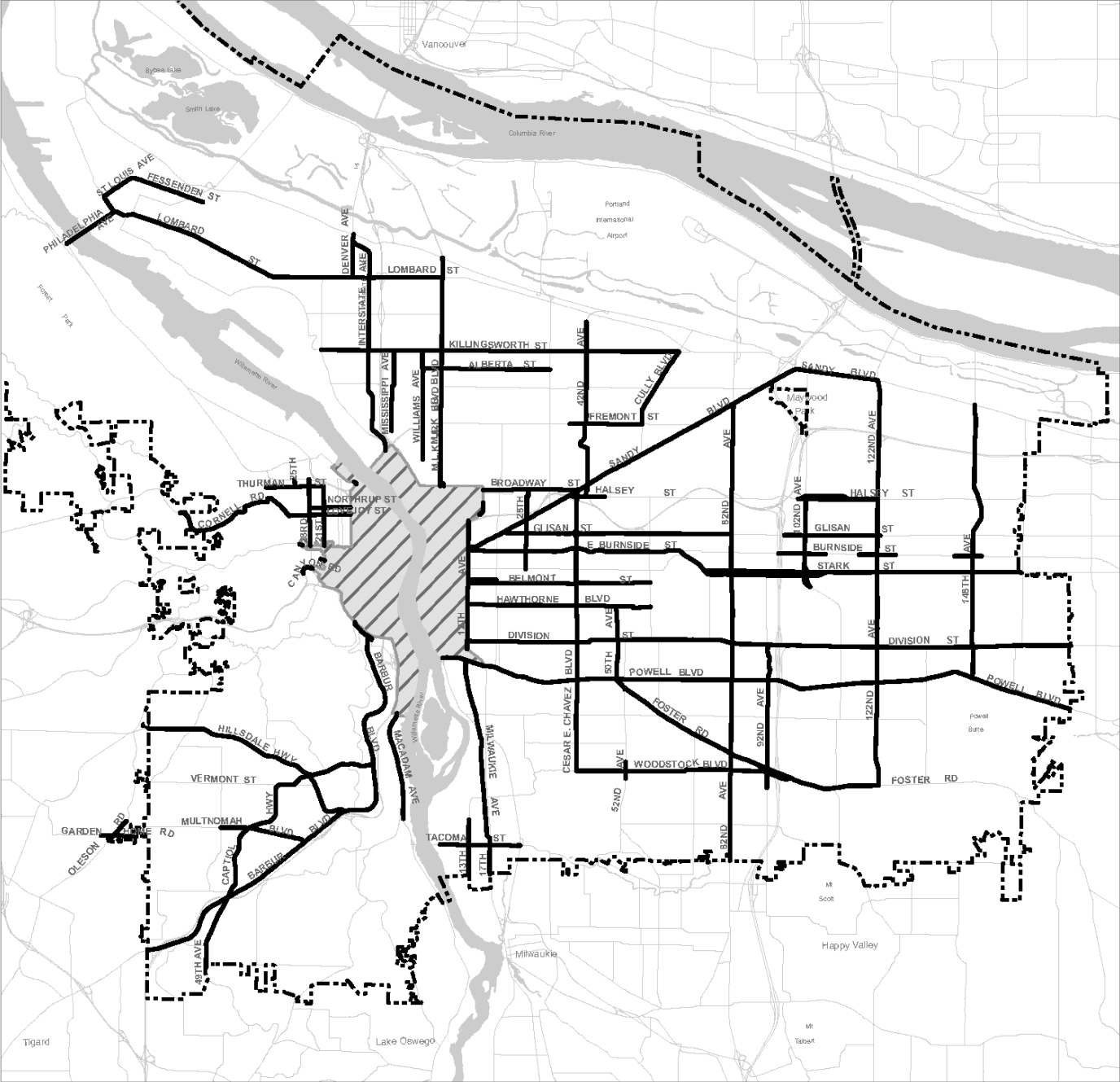

- City Boundary
- Civic and Neighborhood Corridors
- ▨ Central City Plan District

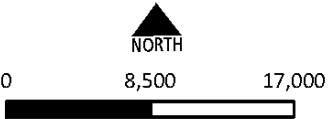

Scale in Feet
 Bureau of Planning and Sustainability
 Portland, Oregon

Source: Portland Bureau of Transportation, TSP, Street Design Classifications

Minimum Required Site Frontage Areas

Map 120-2

Map Revised March 1, 2020

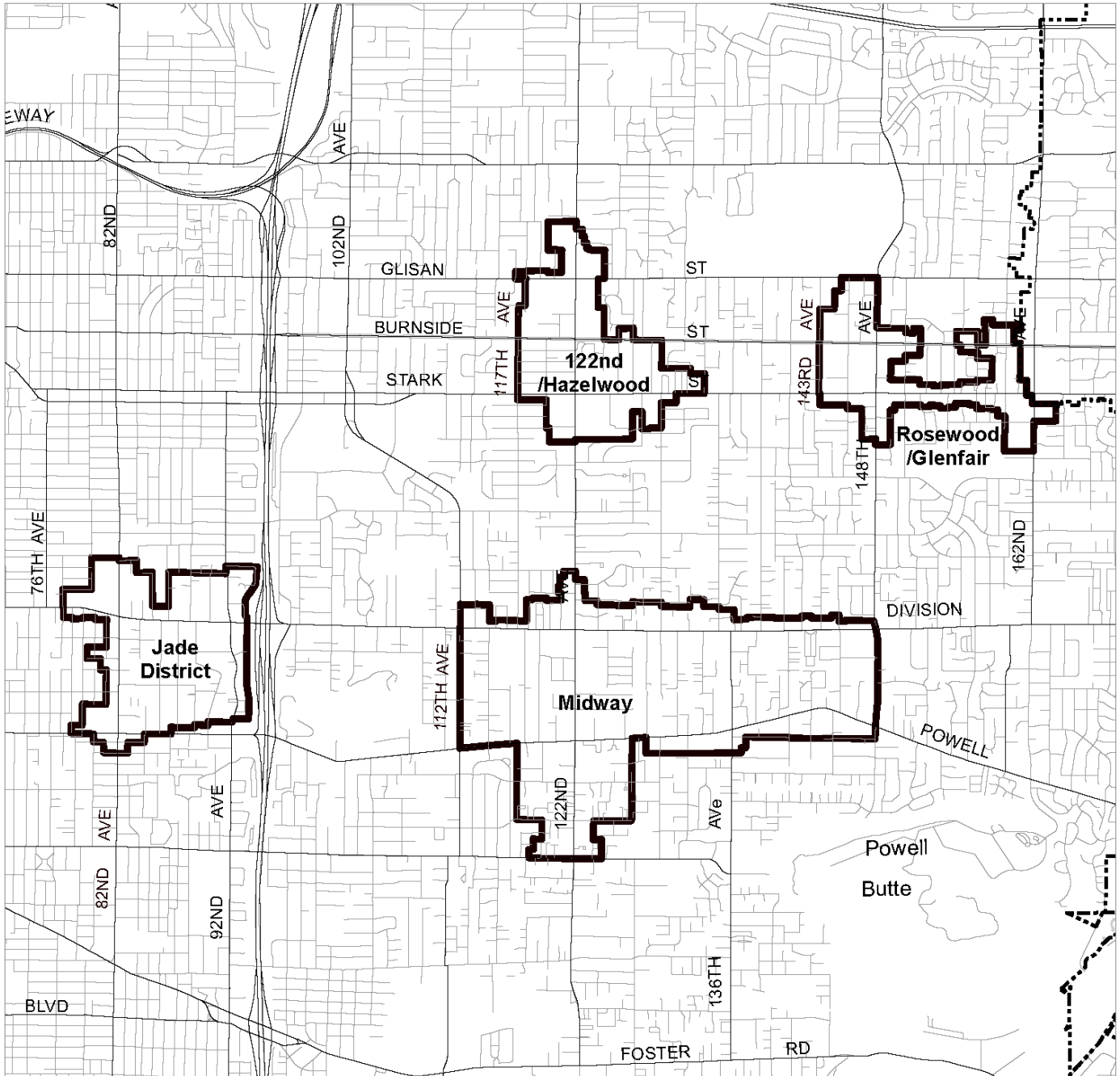

- City Boundary
- Minimum required site frontage areas

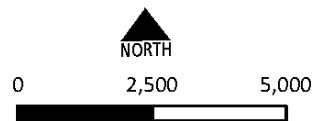

Scale in Feet
Bureau of Planning and Sustainability
Portland, Oregon

Pattern Areas

Map 120-3

Map Revised March 1, 2020

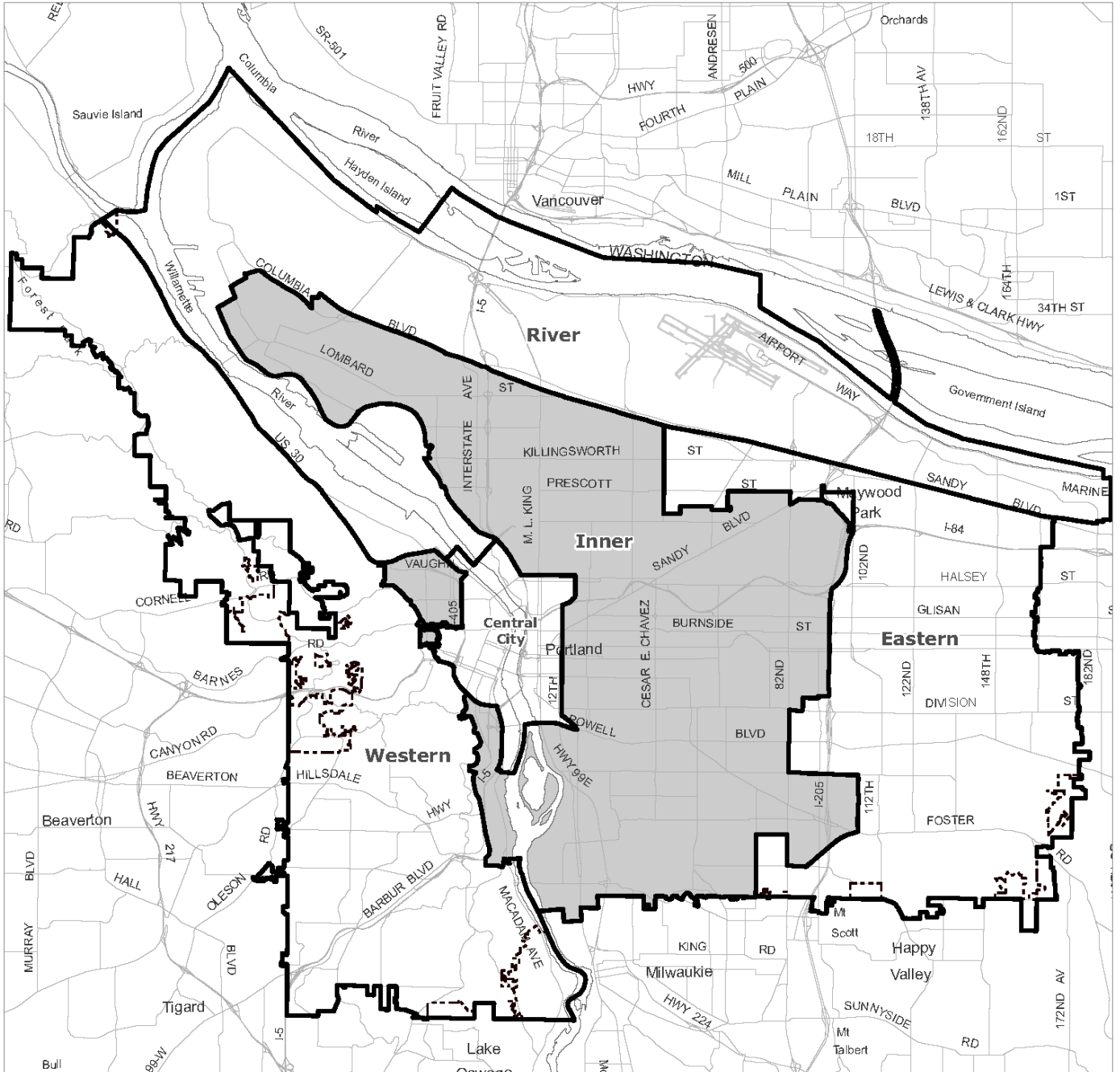

----- City Boundary

———— Pattern Area Boundaries



0 9,000 18,000

Scale in Feet

Bureau of Planning and Sustainability
Portland, Oregon

