

# Plaza de San Isidro

A 41 Acre Retail Development

NEC Loop 20 @ McPherson Rd.  
Laredo, Texas



100 E. Anderson Lane  
Suite 200  
Austin, TX 78752  
(512) 833-6444

Steve Durhman, Agent  
[steve@dbrealty.net](mailto:steve@dbrealty.net)  
Derek Quinn, Agent  
[derek@dbrealty.net](mailto:derek@dbrealty.net)

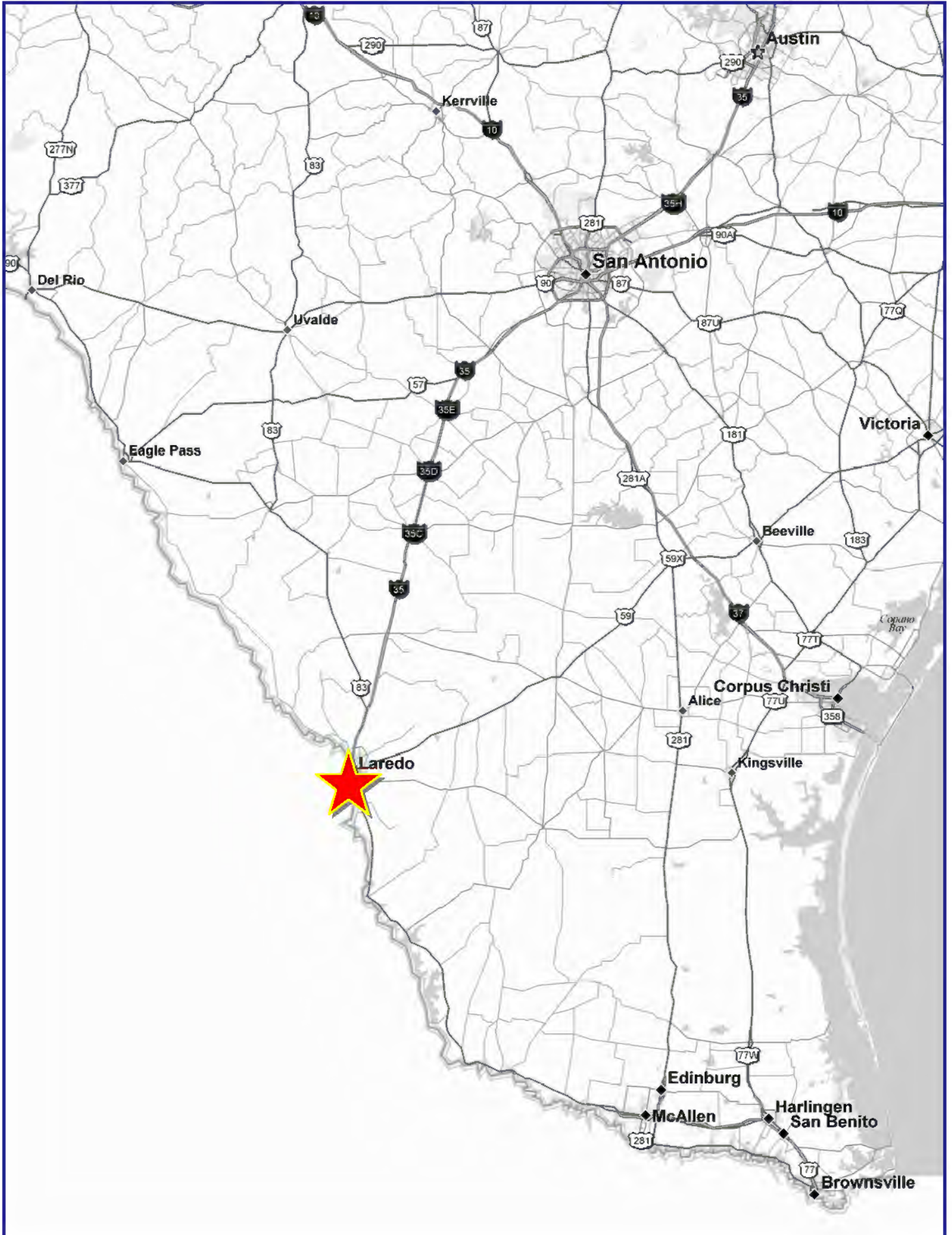

LAREDO UNITED HIGH SCHOOL  
(4,000 ENROLLMENT)

3,000 TO 4,000  
PLANNED HOMES  
500 EXISTING

- Mall Del Norte
- Dillards
  - Sears
  - Macy's
  - Joe Brand
  - Mervyn's
  - Cinemark Theatres
  - JC Penney



Durhman & Bassett  
REALTY GROUP, INC.  
(512) 833-6444



# SAN ISIDRO RANCH

LAREDO, TX



INTERSTATE 35

LOOP 20

LOOP 20



TEXAS A&M INTERNATIONAL UNIVERSITY  
5,500 ENROLLMENT





LAREDO UNITED HIGH SCHOOL  
4,000 STUDENTS

Academy  
SPORTS OUTDOORS

EASTPOINT INDUSTRIAL PARK

Under Construction

PETSMART  
11,220 SF  
Available

SPEC'S  
MEAT MARKET FOODS

Pad Sites

Under Construction

GREASE MONKEY  
OIL CHANGES & MORE

BUSH'S CHICKEN

stripes

Freddy's

McALISTER'S

P.F. CHANG'S

Black Bear

INTERSTATE 69W

LOOP 20

Coming Soon

Burlington

Chedda's

1.29 Acre Pad Site

IHOP

Double Drive Thru

LOOP 20

DISCOUNT TIRE

CHASE

Applebee's

Sprint

BlueWave

CAVENDERS

DOLLAR TREE

MURPHY OIL CORPORATION

AutoZone

Walmart

ANCIRA AUTO DEALERSHIP

CARMAX

LOOP 20

McDonald's

Chick-fil-A

Target

PETCO

ULTA

CONVENERS

SMOOTHIE KING

posh sushi

ROSS DRESS FOR LESS

HOBBY LOBBY

TJ-MAXX

H-E-B plus!

MONARCH DR.

WELLS FARGO

7-Eleven

INTERNATIONAL BLVD.

M'PHERSON RD.



LAREDO UNITED  
HIGH SCHOOL  
4,000 STUDENTS

Academy  
SPORTS • OUTDOORS

Walmart

INTERNATIONAL BLVD.

ALAMO  
DRAFTHOUSE CINEMA

EASTPOINT  
INDUSTRIAL PARK

Cheddar's

Burlington

11,950 SF  
OUTPARCEL  
BUILDING

PETCO

ROSS  
DRESS FOR LESS

HOBBY  
LOBBY

TJ-MAXX

MONARCH DR.

H-E-B  
plus!

at&t

WELLS  
FARGO

CVS

VALERO

LOOP  
20

McPHERSON RD.

DOCTOR'S  
HOSPITAL



# SITE PLAN

PLAZA DE SAN ISIDRO

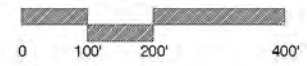

PROJECT NO.: 14012  
 DATE: 05/11/2023

## EXHIBIT PLAZA DE SAN ISIDRO

LAREDO, TEXAS



<b>SAN ANTONIO</b> 123 Atgoff Ave San Antonio, Texas 78201 T: (210) 736-5009	<b>LAREDO</b> 9901 McPherson Ave, Ste 104 Laredo, Texas 78045 T: (956) 791-0405
---	--

# SITE PLAN

OLIVE GARDEN

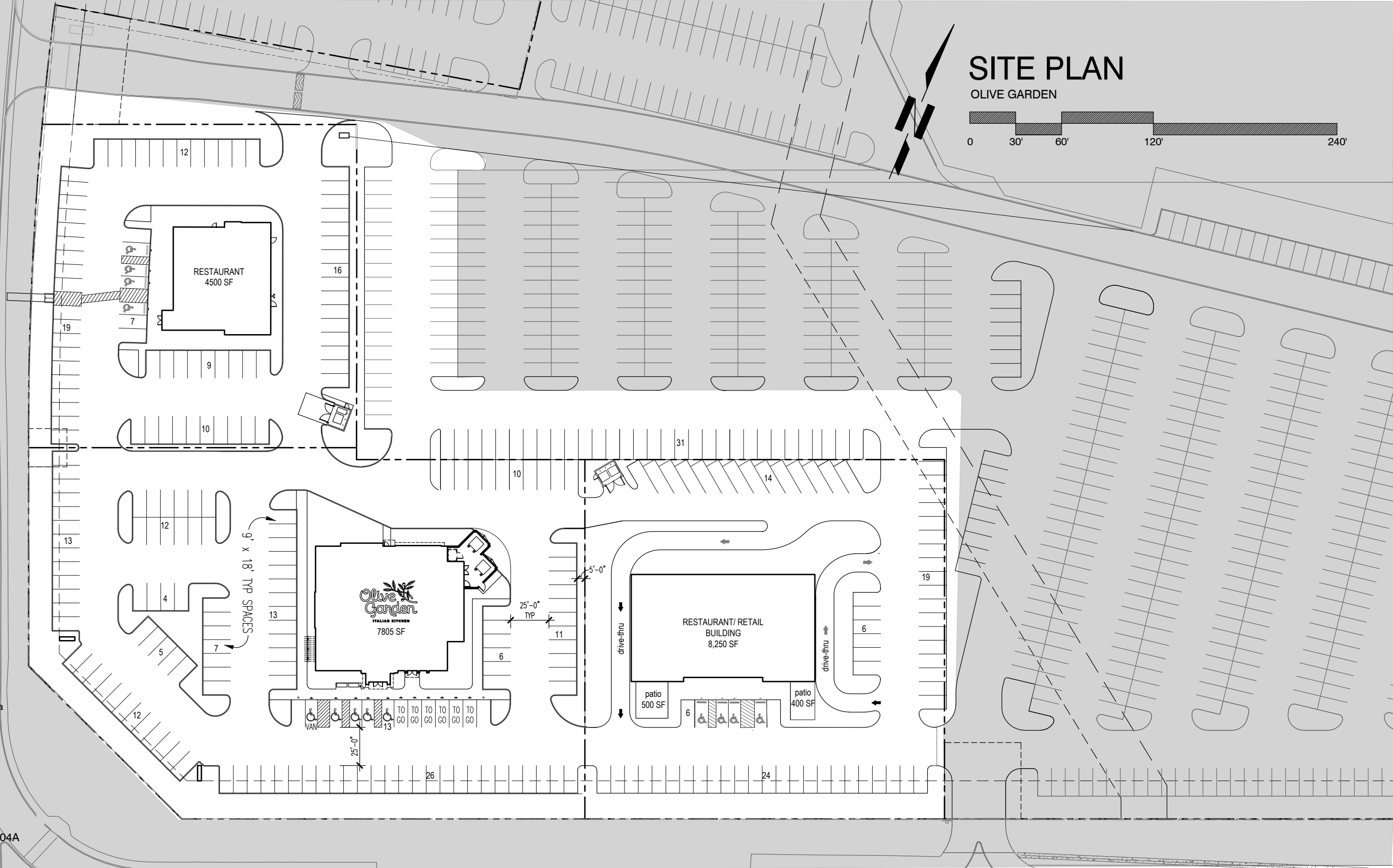
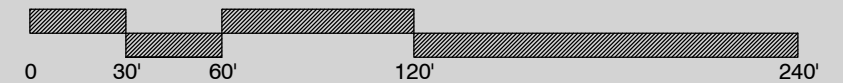

PRELIMINARY  
This Drawing indicates the design concept and the general scope of the project. It is not yet a completed contract document.  
**Not for regulatory approval, permitting or construction.**  
REGISTERED ARCHITECT  
MADELINE ANZ SLAY  
LICENSE NO. 16442  
Date: \_\_\_\_\_

PROJECT NO.: 22004A  
DATE: 03/28/2023

**EXHIBIT**  
**McPherson/ Loop 20 Corner Retail**  
**SAN ISIDRO RANCH**  
**LAREDO, TEXAS**



**SAN ANTONIO**  
123 Altgelt Ave  
San Antonio, Texas 78201  
T: (210) 736-3009

**LAREDO**  
9901 McPherson Ave, Ste 104  
Laredo, Texas 78045  
T: (956) 791-0405



PRELIMINARY  
 This Drawing indicates design concept and the scope of the project. It is not yet a completed contract document.  
**Not for regulatory approval, permitting or construction.**  
 REGISTERED  
 MADELINE ANZ SLAY  
 LICENSE NO. \_\_\_\_\_  
 Date: \_\_\_\_\_

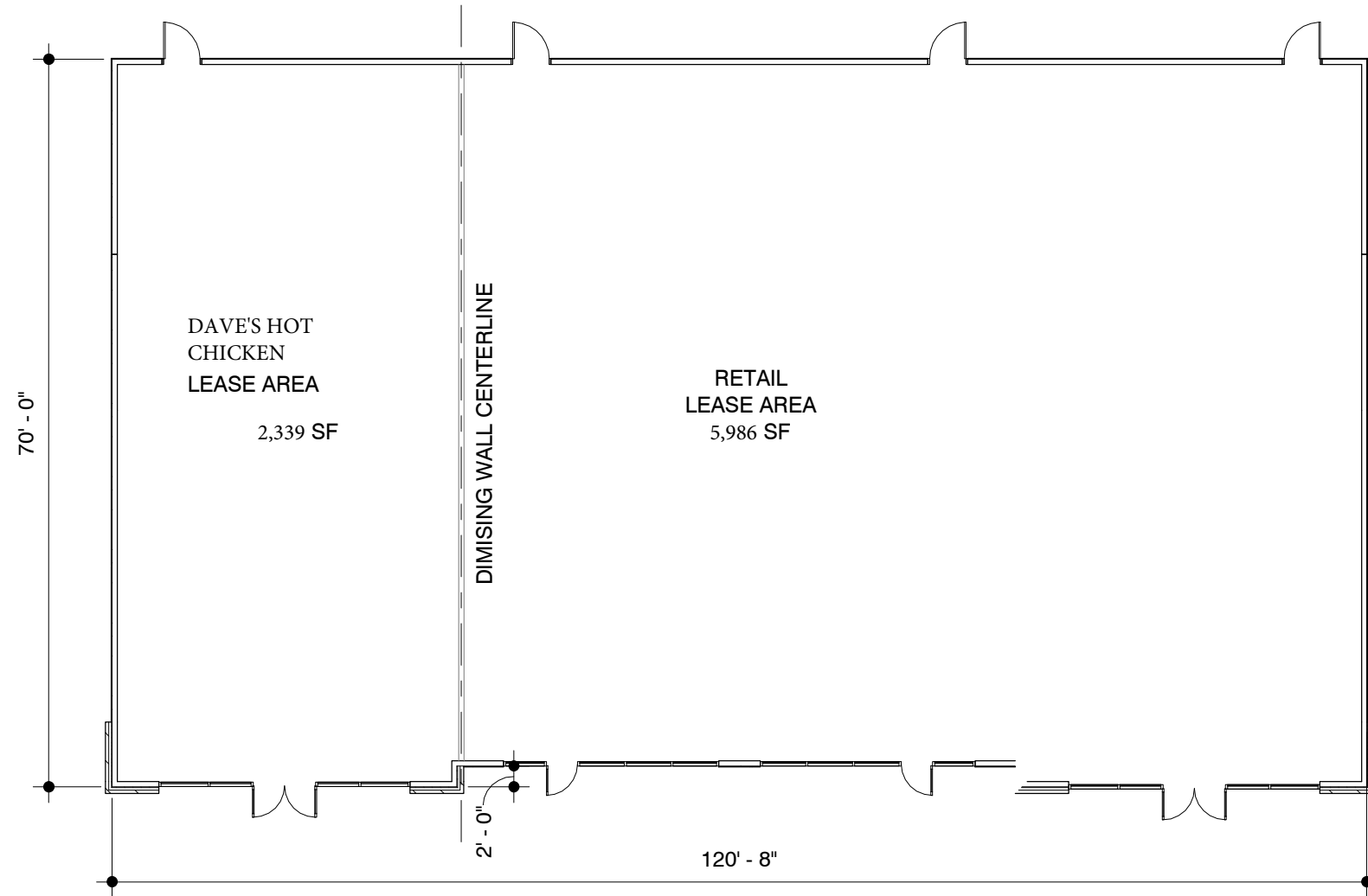

**1 FLOOR PLAN**



PROJECT NO.: 14012  
 DATE: 06/21/2023

**LEASABLE AREA  
 EXHIBIT  
 RETAIL BUILDING AT PLAZA DE SAN ISIDRO  
 LAREDO, TEXAS**



<b>SAN ANTONIO</b> 123 Altgelt Avenue San Antonio, Texas 78201 T: (210) 736-3009	<b>LAREDO</b> 9901 McPherson Road, Ste 104 Laredo, Texas 78045 T: (956) 791-0405
---	---

PRELIMINARY  
 This Drawing indicates design concept and the scope of the project. It is not yet a completed contract document.  
**Not for regulatory approval, permitting or construction.**  
 REGISTERED  
 MADELINE ANZ SLAY  
 LICENSE NO. \_\_\_\_\_  
 Date: \_\_\_\_\_



**1** ELEVATION



PROJECT NO.: 14012  
 DATE: 06/21/2023

**LEASABLE AREA  
 EXHIBIT  
 RETAIL BUILDING AT PLAZA DE SAN ISIDRO  
 LAREDO, TEXAS**



<b>SAN ANTONIO</b> 123 Altgelt Avenue San Antonio, Texas 78201 T: (210) 736-3009	<b>LAREDO</b> 9901 McPherson Road, Ste 104 Laredo, Texas 78045 T: (956) 791-0405
---	---

### FINISH LEGEND

P - PAINT			
	DESCRIPTION	COLOR	MANUFACTURER
P-1	FIELD COLOR	CRAFTSMAN BROWN SW 2835	SHERWIN WILLIAMS
P-2	EIFS CORNICE	TBD	SHERWIN WILLIAMS
P-3	COPING / DOWNSPOUTS / CANOPIES	TBD	SHERWIN WILLIAMS
ST - STONE			
	DESCRIPTION	COLOR	MANUFACTURER
ST	ADHERED STONE VENEER	FREEDOM / YORKTOWN	CORONADO STONE
PT - PORCELAIN TILE			
	DESCRIPTION	COLOR	MANUFACTURER
PT	ABOVE STOREFRONT / 12X24	IRONCRAFT / "CHARCOAL GRAY" / LIGHT POLISHED	DALTILE

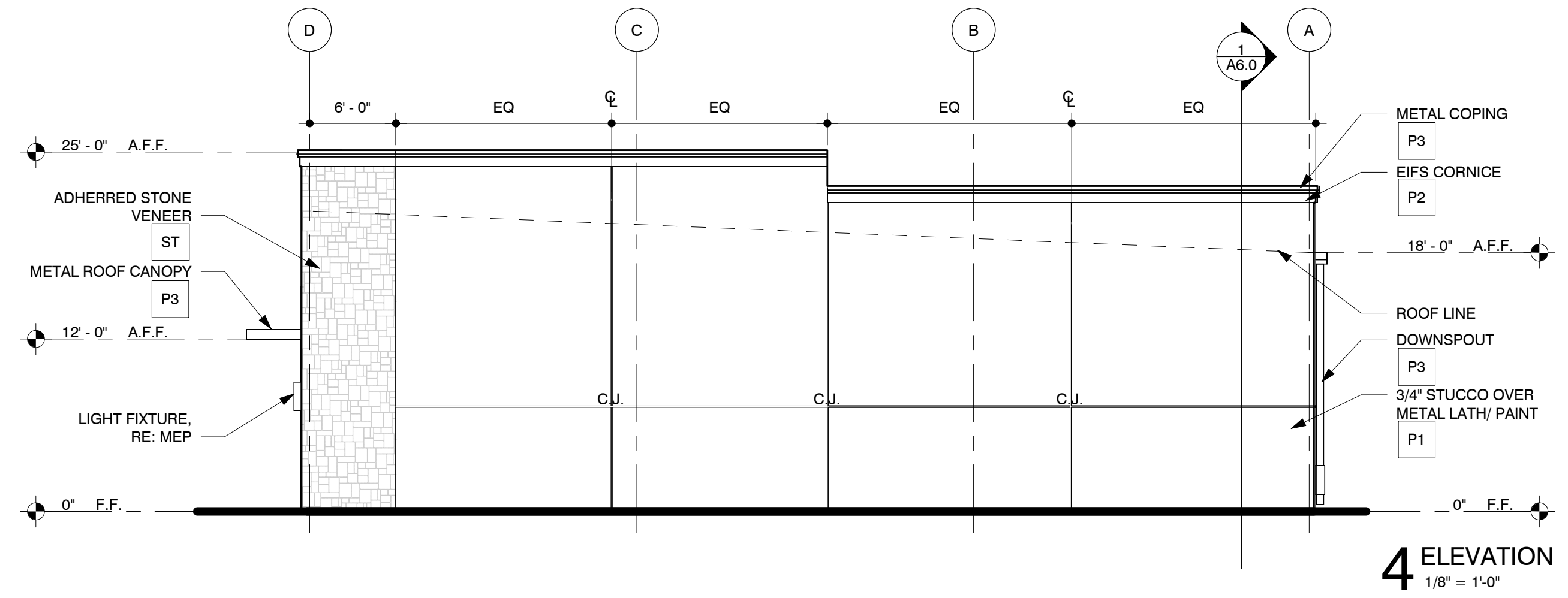

**4 ELEVATION**  
1/8" = 1'-0"

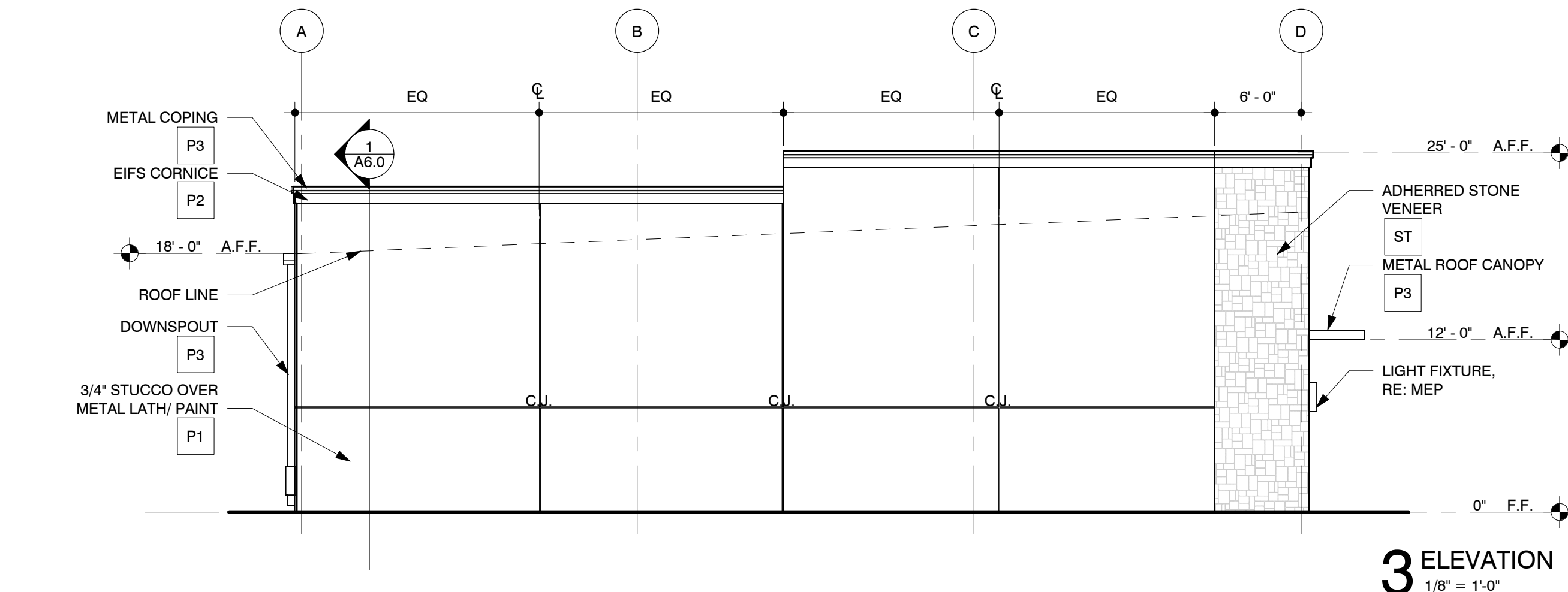

**3 ELEVATION**  
1/8" = 1'-0"

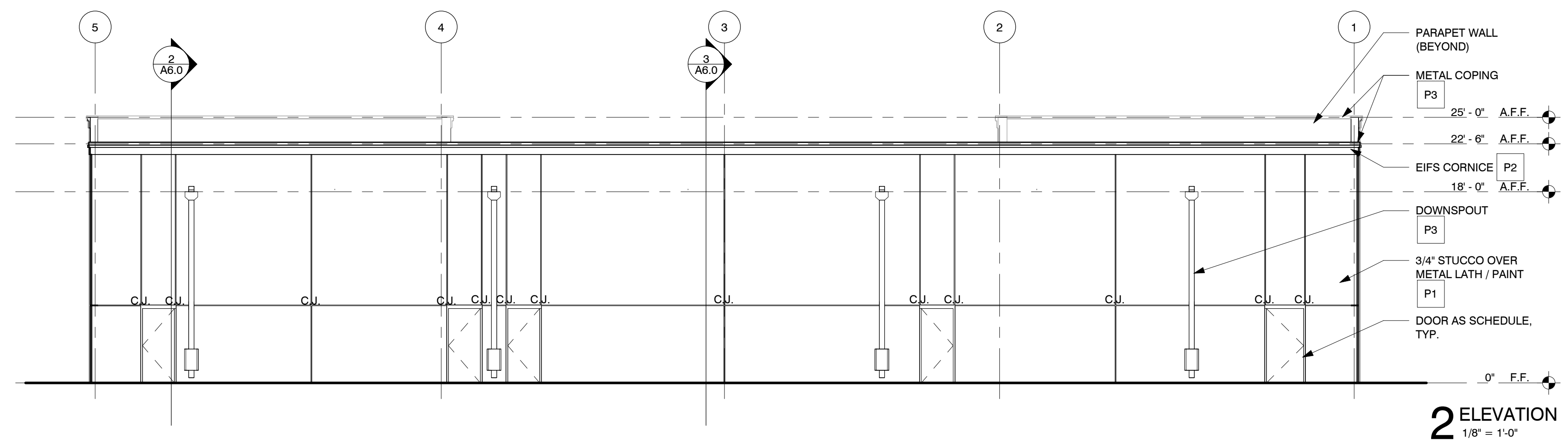

**2 ELEVATION**  
1/8" = 1'-0"

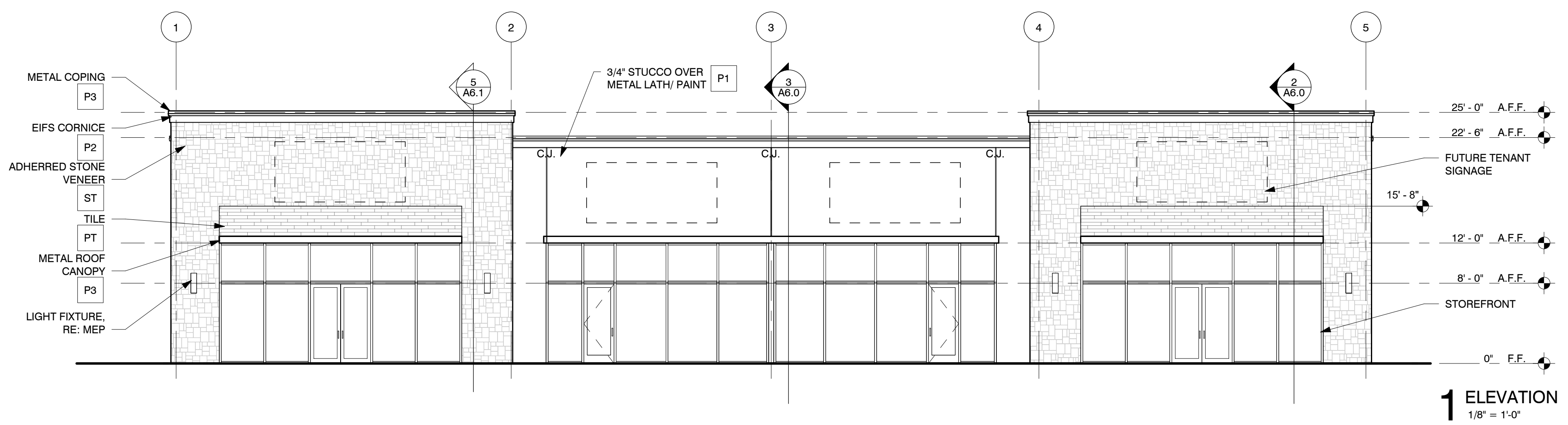

**1 ELEVATION**  
1/8" = 1'-0"

PRELIMINARY  
This Drawing indicates the design concept and the general scope of the project. It is not yet a completed contract document.  
**Not for regulatory approval, permitting or construction.**  
REGISTERED ARCHITECT  
MADELINE ANZ SLAY  
LICENSE NO. 16442  
Date: 10/09/2015



PROJECT NO.: 15015  
DATE: 10/09/2015

**RETAIL SHELL BUILDING AT PLAZA DE SAN ISIDRO**  
**SAN ISIDRO MANAGEMENT**  
**2302 BOB BULLOCK LOOP- LOOP 20 LAREDO, TEXAS**

**SLAY**  
ARCHITECTURE

**SAN ANTONIO**  
123 Altgelt Ave  
San Antonio, Texas 78201  
T: (210) 736-3009

**LAREDO**  
9901 McPherson Ave, Ste 104  
Laredo, Texas 78045  
T: (956) 791-0405



International Blvd  
International Blvd, Laredo, Texas, 78045  
Rings: 1, 3, 5 mile radii

Prepared by Esri  
Latitude: 27.61363  
Longitude: -99.46606

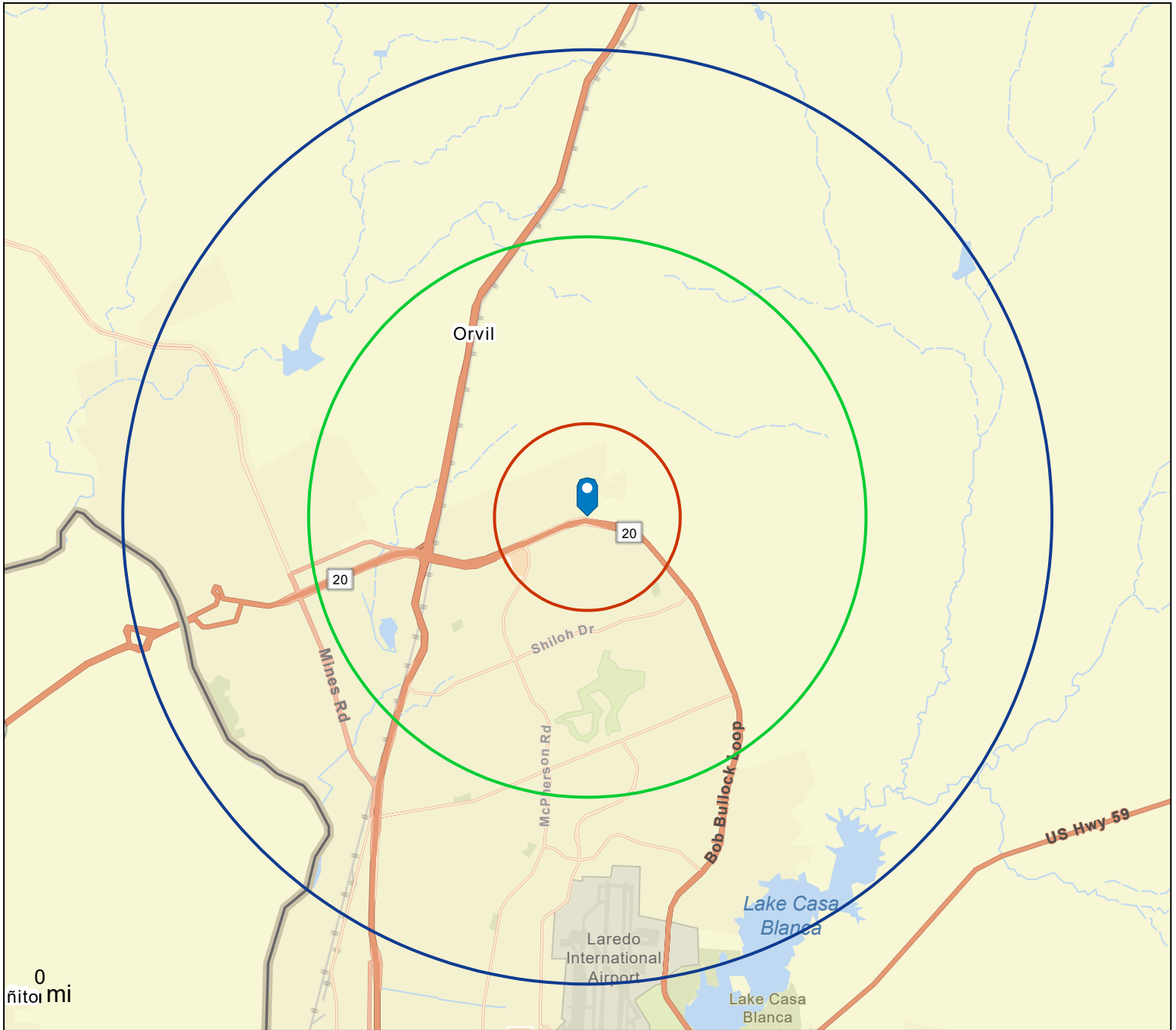

**This site is located in:**

**City:** Laredo  
**County:** Webb County  
**State:** Texas  
**ZIP Code:** 78045  
**Census Tract:** 48479001727  
**Census Block Group:** 484790017272  
**CBSA:** Laredo, TX Metropolitan Statistical Area

International Blvd  
International Blvd, Laredo, Texas, 78045  
Rings: 1, 3, 5 mile radii

Prepared by Esri  
Latitude: 27.61363  
Longitude: -99.46606

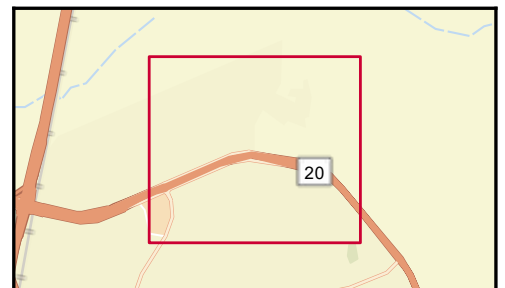
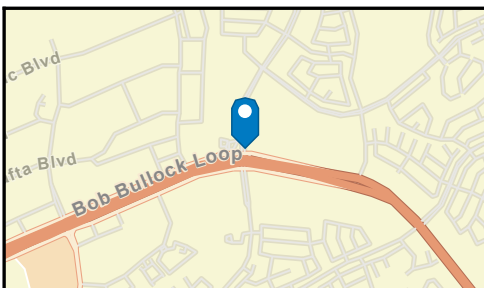
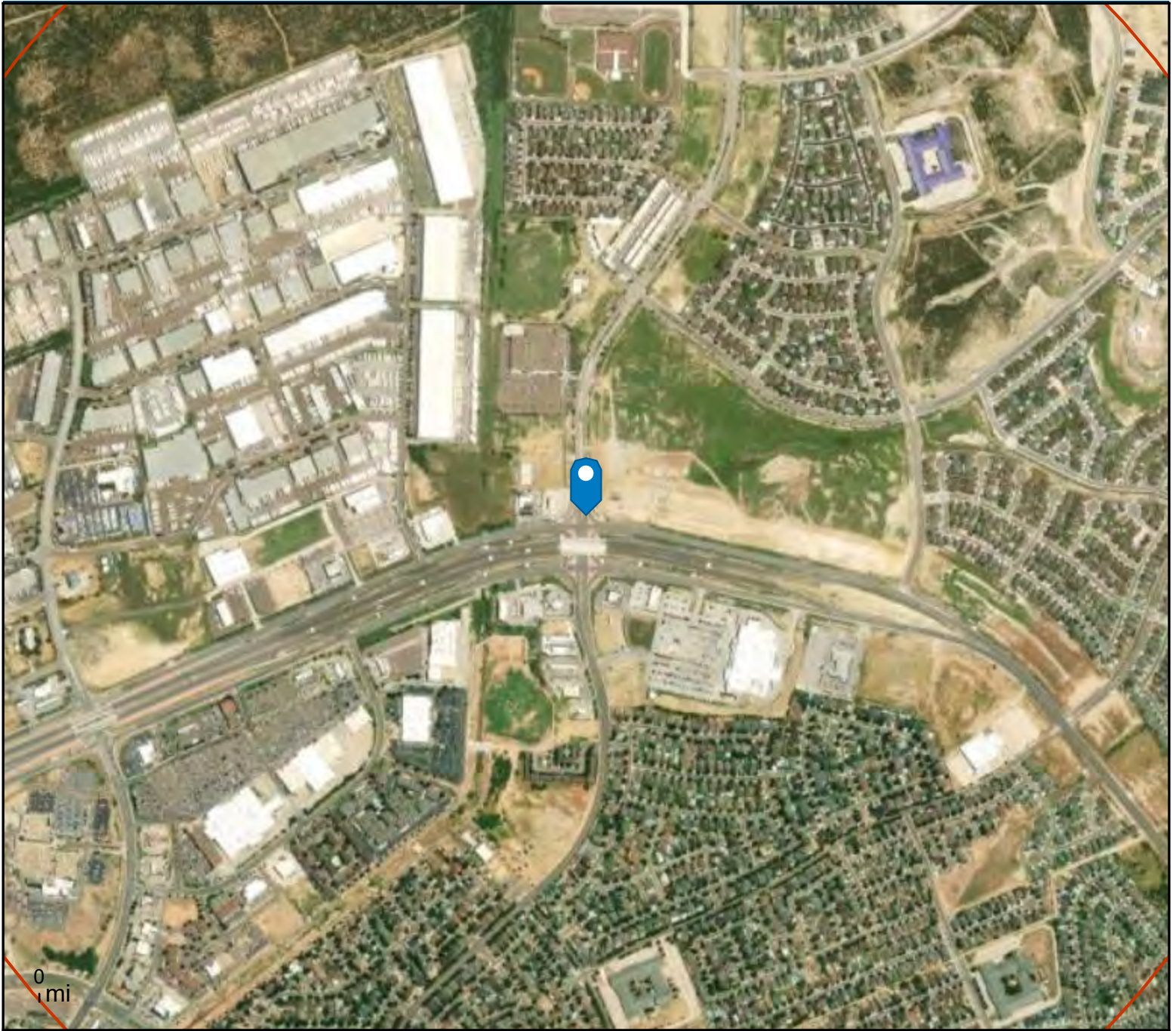



# Executive Summary

International Blvd  
 International Blvd, Laredo, Texas, 78045  
 Rings: 1, 3, 5 mile radii

Prepared by Esri  
 Latitude: 27.61363  
 Longitude: -99.46606

	1 mile	3 miles	5 miles
<b>Population</b>			
2010 Population	6,169	33,200	74,270
2020 Population	10,632	43,847	89,134
2023 Population	10,878	44,939	91,603
2028 Population	11,048	45,612	93,067
2010-2020 Annual Rate	5.59%	2.82%	1.84%
2020-2023 Annual Rate	0.71%	0.76%	0.84%
2023-2028 Annual Rate	0.31%	0.30%	0.32%
2020 Male Population	49.3%	48.6%	48.2%
2020 Female Population	50.7%	51.4%	51.8%
2020 Median Age	31.2	33.6	33.0
2023 Male Population	49.0%	48.8%	48.6%
2023 Female Population	51.0%	51.2%	51.4%
2023 Median Age	31.3	33.3	32.6

In the identified area, the current year population is 91,603. In 2020, the Census count in the area was 89,134. The rate of change since 2020 was 0.84% annually. The five-year projection for the population in the area is 93,067 representing a change of 0.32% annually from 2023 to 2028. Currently, the population is 48.6% male and 51.4% female.

### Median Age

The median age in this area is 32.6, compared to U.S. median age of 39.1.

### Race and Ethnicity

2023 White Alone	35.3%	34.0%	34.2%
2023 Black Alone	0.8%	0.7%	0.7%
2023 American Indian/Alaska Native Alone	0.5%	0.5%	0.6%
2023 Asian Alone	1.5%	1.5%	1.2%
2023 Pacific Islander Alone	0.0%	0.0%	0.0%
2023 Other Race	15.9%	14.5%	16.8%
2023 Two or More Races	45.9%	48.7%	46.6%
2023 Hispanic Origin (Any Race)	92.6%	92.7%	93.3%

Persons of Hispanic origin represent 93.3% of the population in the identified area compared to 19.4% of the U.S. population. Persons of Hispanic Origin may be of any race. The Diversity Index, which measures the probability that two people from the same area will be from different race/ethnic groups, is 68.3 in the identified area, compared to 72.1 for the U.S. as a whole.

### Households

2023 Wealth Index	96	100	86
2010 Households	1,747	9,772	21,464
2020 Households	3,020	13,610	27,518
2023 Households	3,127	14,123	28,652
2028 Households	3,240	14,621	29,684
2010-2020 Annual Rate	5.63%	3.37%	2.52%
2020-2023 Annual Rate	1.08%	1.14%	1.25%
2023-2028 Annual Rate	0.71%	0.70%	0.71%
2023 Average Household Size	3.48	3.17	3.16

The household count in this area has changed from 27,518 in 2020 to 28,652 in the current year, a change of 1.25% annually. The five-year projection of households is 29,684, a change of 0.71% annually from the current year total. Average household size is currently 3.16, compared to 3.20 in the year 2020. The number of families in the current year is 23,382 in the specified area.

**Data Note:** Income is expressed in current dollars. Housing Affordability Index and Percent of Income for Mortgage calculations are only available for areas with 50 or more owner-occupied housing units. The Gini index measures the extent to which the distribution of income or consumption among individuals or households within an economy deviates from a perfectly equal distribution. A Gini index of 0 represents perfect equality, while an index of 100 implies perfect inequality.

**Source:** U.S. Census Bureau. Esri forecasts for 2023 and 2028. Esri converted Census 2010 into 2020 geography and Census 2020 data.





# Executive Summary

International Blvd  
International Blvd, Laredo, Texas, 78045  
Rings: 1, 3, 5 mile radii

Prepared by Esri  
Latitude: 27.61363  
Longitude: -99.46606

	1 mile	3 miles	5 miles
<b>Mortgage Income</b>			
2023 Percent of Income for Mortgage	13.4%	14.8%	17.0%
<b>Median Household Income</b>			
2023 Median Household Income	\$106,836	\$99,893	\$80,137
2028 Median Household Income	\$113,028	\$106,083	\$92,965
2023-2028 Annual Rate	1.13%	1.21%	3.01%
<b>Average Household Income</b>			
2023 Average Household Income	\$125,101	\$120,083	\$105,444
2028 Average Household Income	\$139,118	\$133,573	\$118,548
2023-2028 Annual Rate	2.15%	2.15%	2.37%
<b>Per Capita Income</b>			
2023 Per Capita Income	\$36,270	\$37,829	\$32,977
2028 Per Capita Income	\$41,144	\$42,928	\$37,806
2023-2028 Annual Rate	2.55%	2.56%	2.77%
<b>GINI Index</b>			
2023 Gini Index	28.7	34.7	37.8

### Households by Income

Current median household income is \$80,137 in the area, compared to \$72,603 for all U.S. households. Median household income is projected to be \$92,965 in five years, compared to \$82,410 for all U.S. households

Current average household income is \$105,444 in this area, compared to \$107,008 for all U.S. households. Average household income is projected to be \$118,548 in five years, compared to \$122,048 for all U.S. households

Current per capita income is \$32,977 in the area, compared to the U.S. per capita income of \$41,310. The per capita income is projected to be \$37,806 in five years, compared to \$47,525 for all U.S. households

<b>Housing</b>			
2023 Housing Affordability Index	153	140	122
2010 Total Housing Units	1,815	10,389	22,708
2010 Owner Occupied Housing Units	1,458	7,748	15,830
2010 Renter Occupied Housing Units	289	2,023	5,635
2010 Vacant Housing Units	68	617	1,244
2020 Total Housing Units	3,111	14,260	29,008
2020 Owner Occupied Housing Units	2,611	10,205	19,277
2020 Renter Occupied Housing Units	409	3,405	8,241
2020 Vacant Housing Units	99	646	1,486
2023 Total Housing Units	3,237	14,874	30,352
2023 Owner Occupied Housing Units	2,359	9,946	19,814
2023 Renter Occupied Housing Units	768	4,177	8,838
2023 Vacant Housing Units	110	751	1,700
2028 Total Housing Units	3,337	15,329	31,333
2028 Owner Occupied Housing Units	2,463	10,397	20,759
2028 Renter Occupied Housing Units	776	4,224	8,925
2028 Vacant Housing Units	97	708	1,649

### Socioeconomic Status Index

2023 Socioeconomic Status Index	60.1	54.4	49.2
---------------------------------	------	------	------

Currently, 65.3% of the 30,352 housing units in the area are owner occupied; 29.1%, renter occupied; and 5.6% are vacant. Currently, in the U.S., 58.5% of the housing units in the area are owner occupied; 31.7% are renter occupied; and 9.8% are vacant. In 2020, there were 29,008 housing units in the area and 5.1% vacant housing units. The annual rate of change in housing units since 2020 is 1.40%. Median home value in the area is \$226,809, compared to a median home value of \$308,943 for the U.S. In five years, median value is projected to change by 4.77% annually to \$286,282.

**Data Note:** Income is expressed in current dollars. Housing Affordability Index and Percent of Income for Mortgage calculations are only available for areas with 50 or more owner-occupied housing units. The Gini index measures the extent to which the distribution of income or consumption among individuals or households within an economy deviates from a perfectly equal distribution. A Gini index of 0 represents perfect equality, while an index of 100 implies perfect inequality.  
**Source:** U.S. Census Bureau. Esri forecasts for 2023 and 2028. Esri converted Census 2010 into 2020 geography and Census 2020 data.

2023 Population by Race

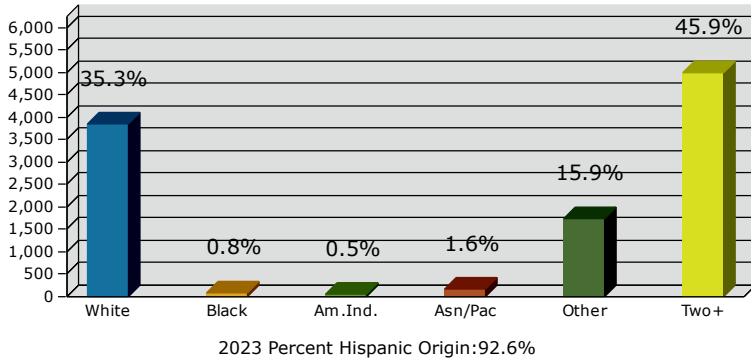

2023 Population by Age

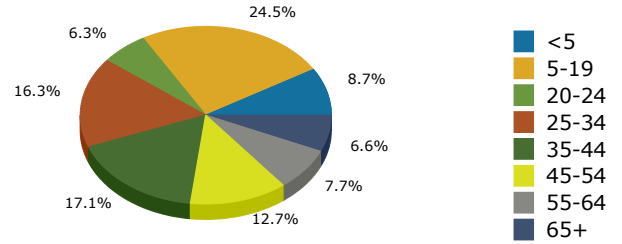

Households

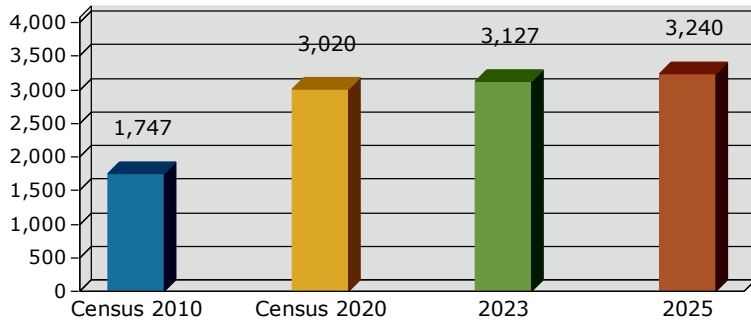

2023 Home Value

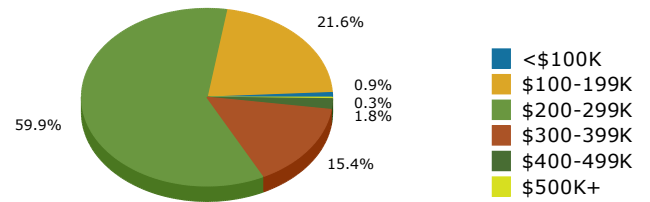

2023-2028 Annual Growth Rate

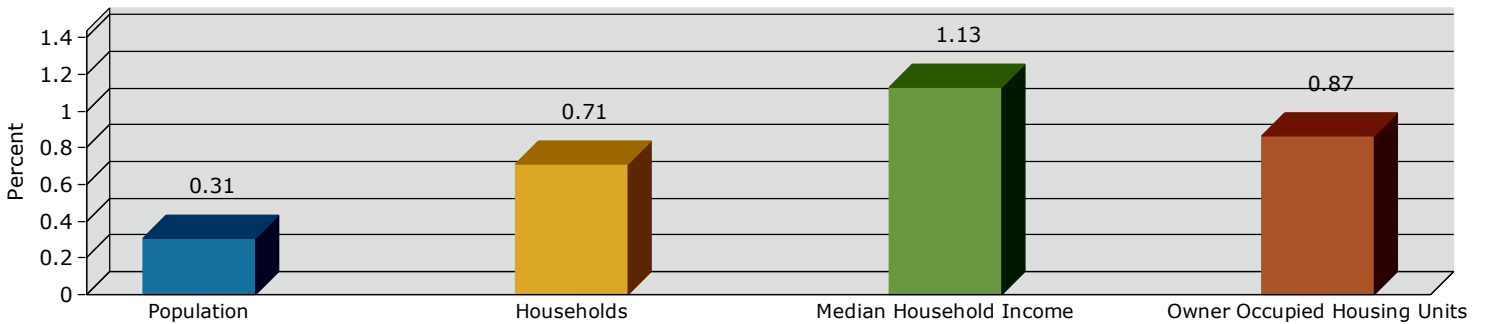

Household Income

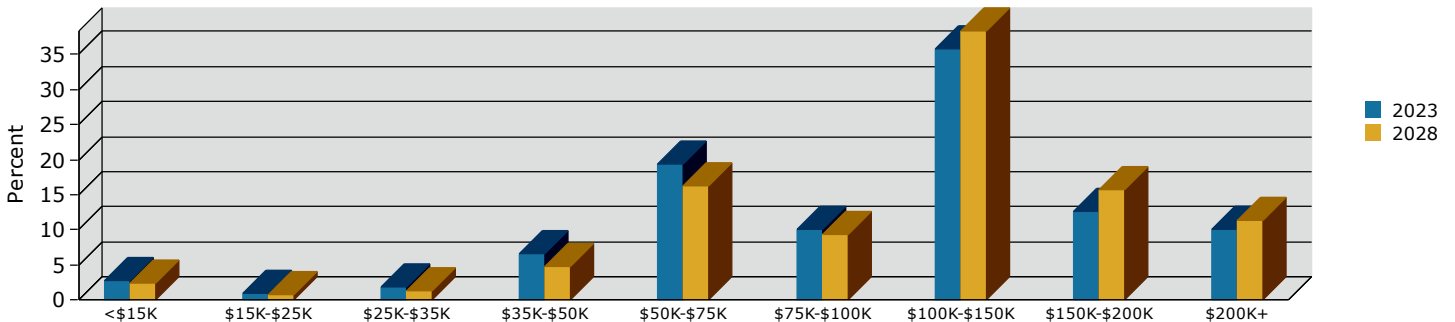

Source: Esri forecasts for 2023 and 2028. U.S. Census Bureau 2010 decennial Census data converted by Esri into 2020 geography.

2023 Population by Race

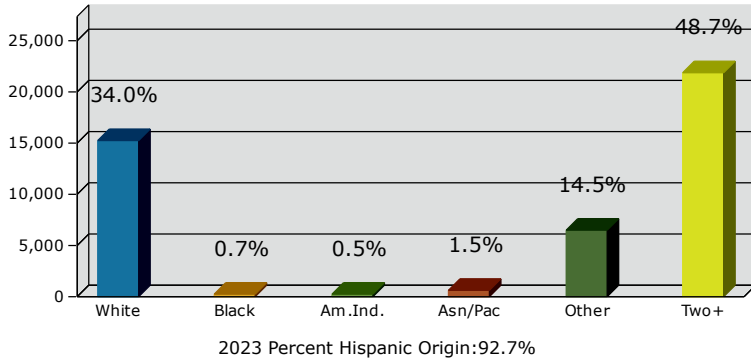

2023 Population by Age

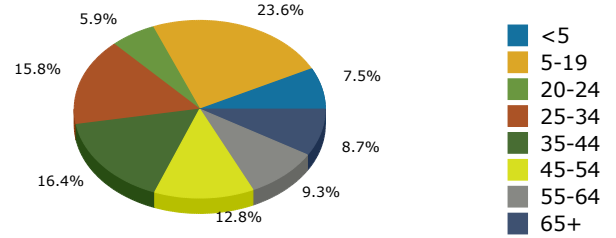

Households

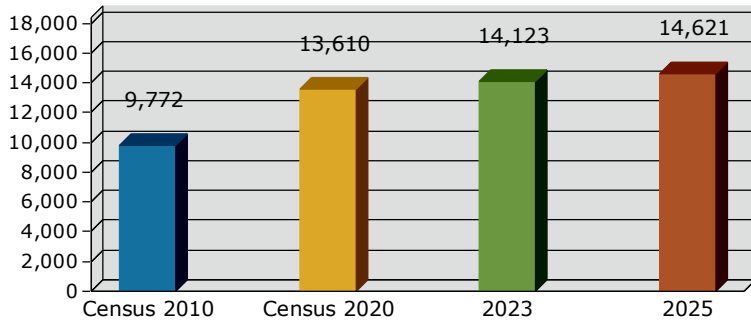

2023 Home Value

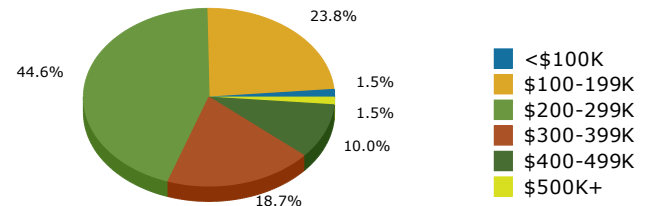

2023-2028 Annual Growth Rate

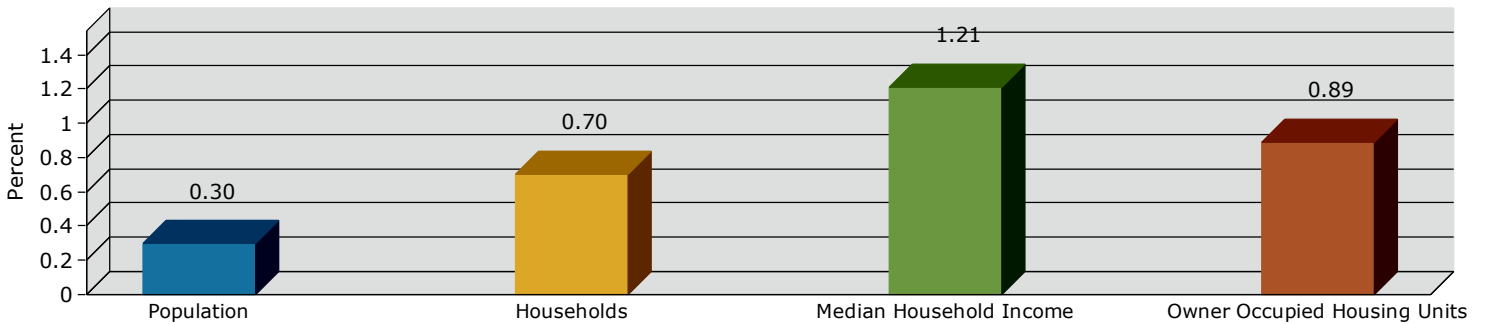

Household Income

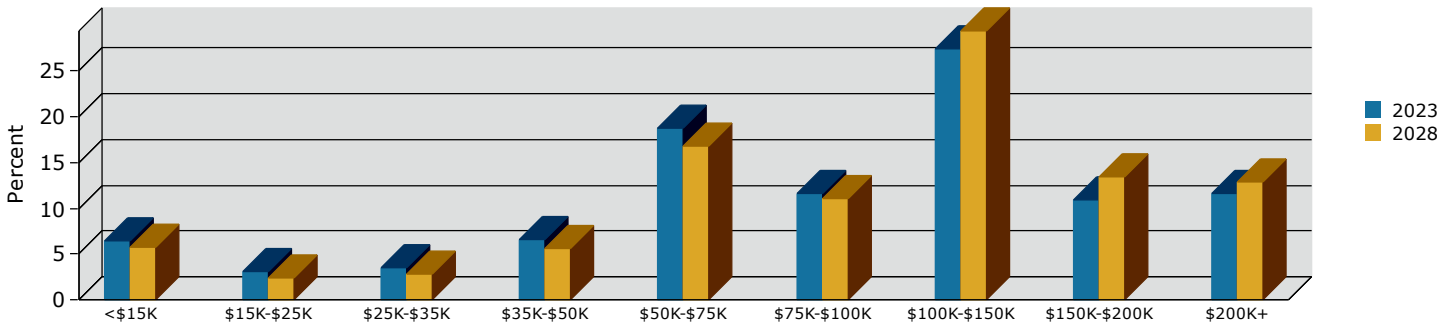

Source: Esri forecasts for 2023 and 2028. U.S. Census Bureau 2010 decennial Census data converted by Esri into 2020 geography.

2023 Population by Race

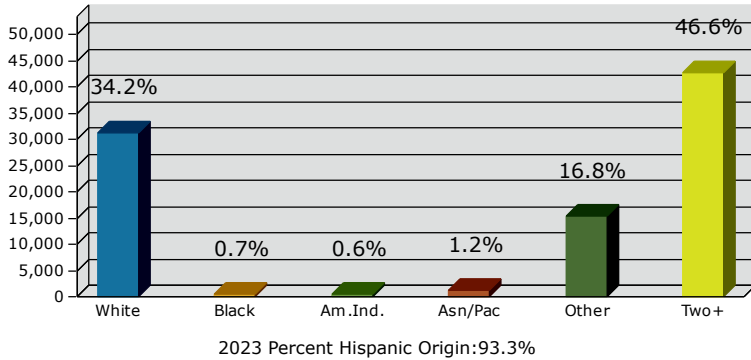

2023 Population by Age

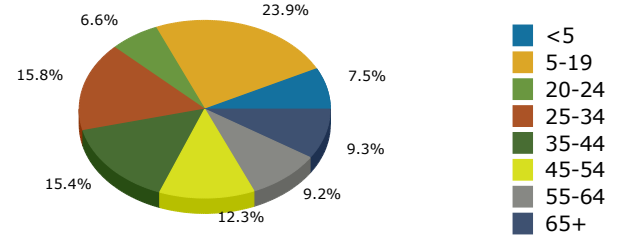

Households

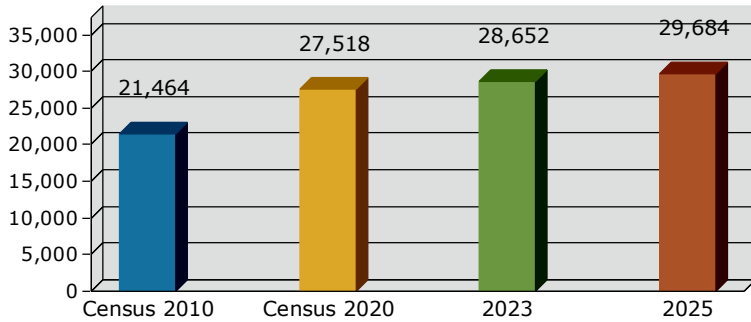

2023 Home Value

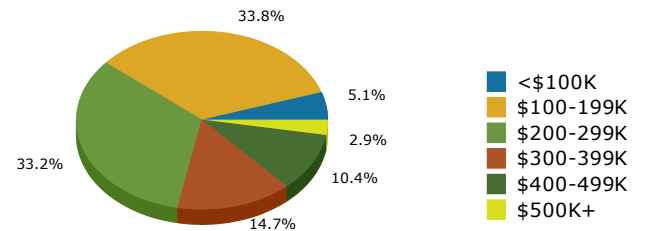

2023-2028 Annual Growth Rate

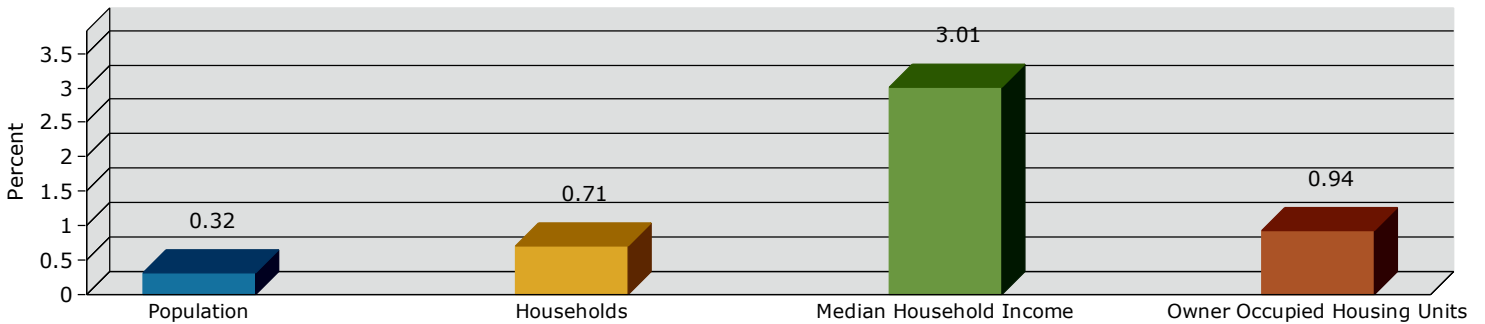

Household Income

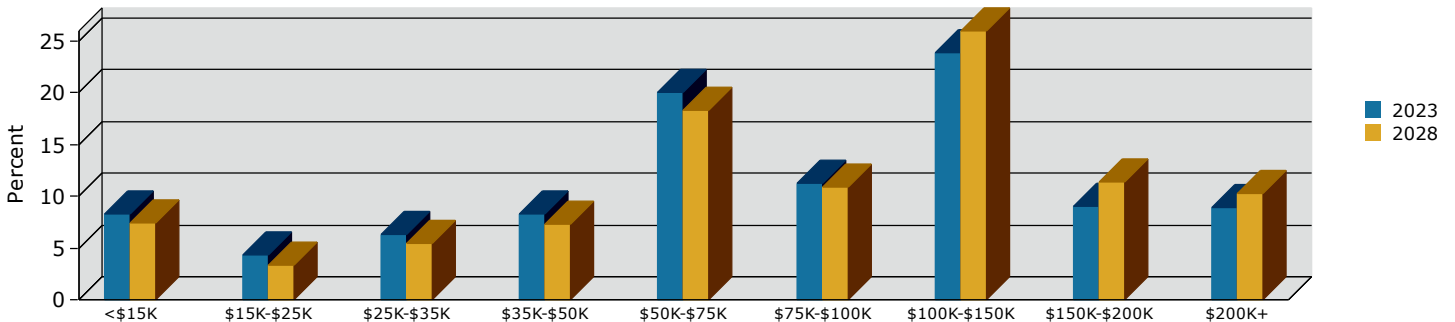

Source: Esri forecasts for 2023 and 2028. U.S. Census Bureau 2010 decennial Census data converted by Esri into 2020 geography.

International Blvd  
 International Blvd, Laredo, Texas, 78045  
 Rings: 1, 3, 5 mile radii

Prepared by Esri  
 Latitude: 27.61363  
 Longitude: -99.46606

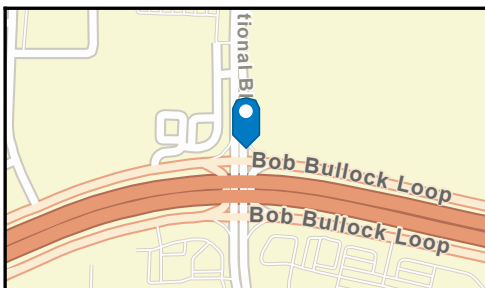
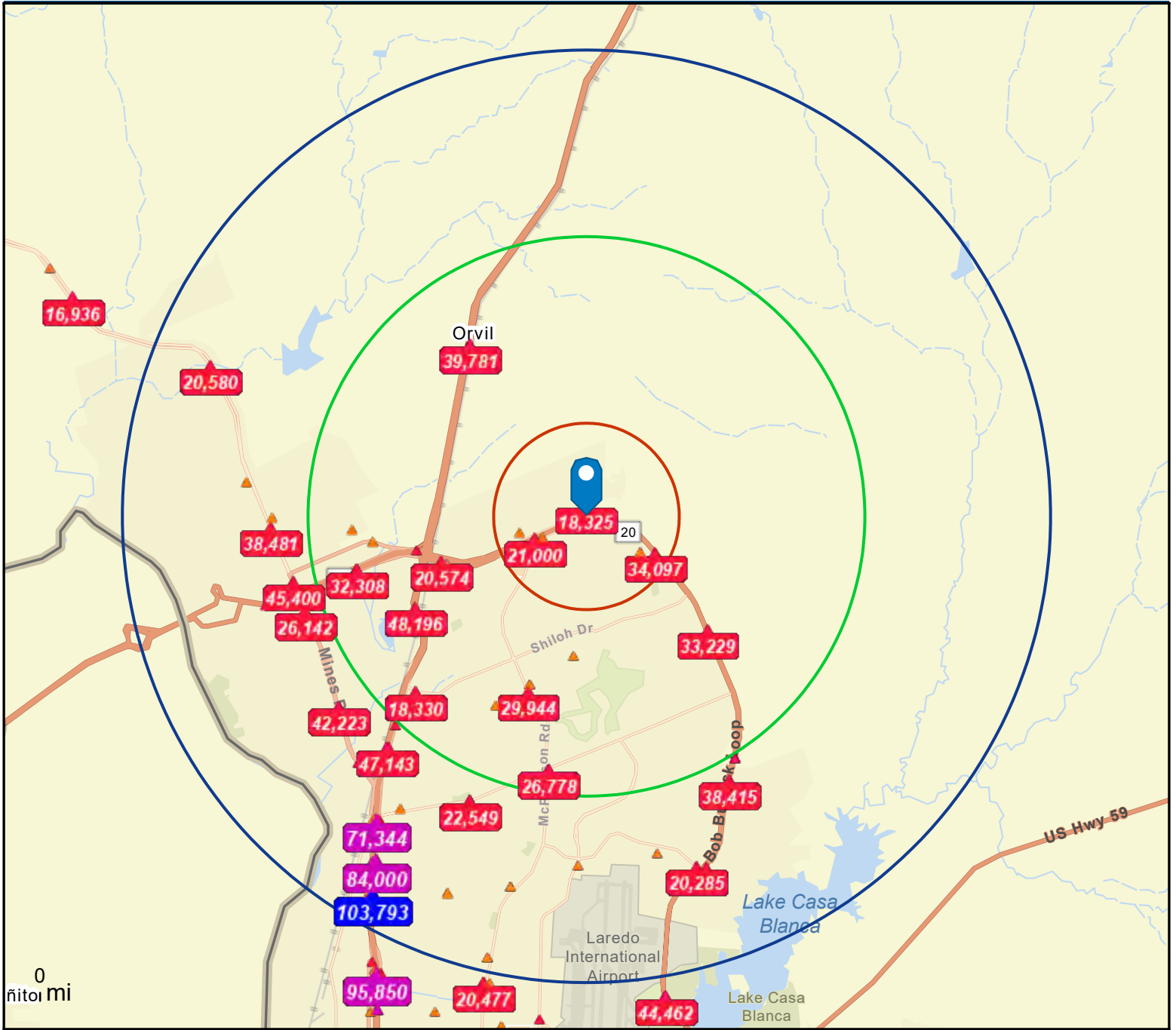

- Average Daily Traffic Volume**
- ▲ Up to 6,000 vehicles per day
  - ▲ 6,001 - 15,000
  - ▲ 15,001 - 30,000
  - ▲ 30,001 - 50,000
  - ▲ 50,001 - 100,000
  - ▲ More than 100,000 per day

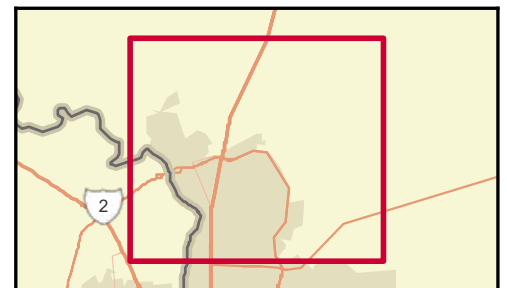

Source: ©2023 Kalibrate Technologies (Q3 2023).



# Market Profile

International Blvd  
 International Blvd, Laredo, Texas, 78045  
 Rings: 1, 3, 5 mile radii

Prepared by Esri  
 Latitude: 27.61363  
 Longitude: -99.46606

	1 mile	3 miles	5 miles
<b>Population Summary</b>			
2010 Total Population	6,169	33,200	74,270
2020 Total Population	10,632	43,847	89,134
2020 Group Quarters	0	159	1,166
2023 Total Population	10,878	44,939	91,603
2023 Group Quarters	0	159	1,166
2028 Total Population	11,048	45,612	93,067
2023-2028 Annual Rate	0.31%	0.30%	0.32%
2023 Total Daytime Population	11,949	44,617	100,645
Workers	6,356	21,247	52,123
Residents	5,593	23,370	48,522
<b>Household Summary</b>			
2010 Households	1,747	9,772	21,464
2010 Average Household Size	3.53	3.38	3.42
2020 Total Households	3,020	13,610	27,518
2020 Average Household Size	3.52	3.21	3.20
2023 Households	3,127	14,123	28,652
2023 Average Household Size	3.48	3.17	3.16
2028 Households	3,240	14,621	29,684
2028 Average Household Size	3.41	3.11	3.10
2023-2028 Annual Rate	0.71%	0.70%	0.71%
2010 Families	1,480	8,168	17,985
2010 Average Family Size	3.88	3.73	3.77
2023 Families	2,623	11,467	23,382
2023 Average Family Size	3.86	3.57	3.55
2028 Families	2,706	11,854	24,198
2028 Average Family Size	3.79	3.50	3.48
2023-2028 Annual Rate	0.63%	0.67%	0.69%
<b>Housing Unit Summary</b>			
2000 Housing Units	310	4,667	13,363
Owner Occupied Housing Units	78.1%	81.7%	70.0%
Renter Occupied Housing Units	20.0%	13.9%	24.5%
Vacant Housing Units	1.9%	4.3%	5.5%
2010 Housing Units	1,815	10,389	22,708
Owner Occupied Housing Units	80.3%	74.6%	69.7%
Renter Occupied Housing Units	15.9%	19.5%	24.8%
Vacant Housing Units	3.7%	5.9%	5.5%
2020 Housing Units	3,111	14,260	29,008
Owner Occupied Housing Units	83.9%	71.6%	66.5%
Renter Occupied Housing Units	13.1%	23.9%	28.4%
Vacant Housing Units	3.2%	4.5%	5.1%
2023 Housing Units	3,237	14,874	30,352
Owner Occupied Housing Units	72.9%	66.9%	65.3%
Renter Occupied Housing Units	23.7%	28.1%	29.1%
Vacant Housing Units	3.4%	5.0%	5.6%
2028 Housing Units	3,337	15,329	31,333
Owner Occupied Housing Units	73.8%	67.8%	66.3%
Renter Occupied Housing Units	23.3%	27.6%	28.5%
Vacant Housing Units	2.9%	4.6%	5.3%

**Data Note:** Household population includes persons not residing in group quarters. Average Household Size is the household population divided by total households. Persons in families include the householder and persons related to the householder by birth, marriage, or adoption. Per Capita Income represents the income received by all persons aged 15 years and over divided by the total population.

**Source:** Esri forecasts for 2023 and 2028. U.S. Census Bureau 2000 and 2010 decennial Census data converted by Esri into 2020 geography.



# Market Profile

International Blvd  
 International Blvd, Laredo, Texas, 78045  
 Rings: 1, 3, 5 mile radii

Prepared by Esri  
 Latitude: 27.61363  
 Longitude: -99.46606

	1 mile	3 miles	5 miles
<b>2023 Households by Income</b>			
Household Income Base	3,127	14,123	28,651
<\$15,000	2.7%	6.5%	8.2%
\$15,000 - \$24,999	1.0%	3.1%	4.4%
\$25,000 - \$34,999	1.9%	3.5%	6.3%
\$35,000 - \$49,999	6.6%	6.6%	8.3%
\$50,000 - \$74,999	19.4%	18.7%	20.1%
\$75,000 - \$99,999	10.1%	11.6%	11.2%
\$100,000 - \$149,999	35.8%	27.5%	23.8%
\$150,000 - \$199,999	12.6%	10.9%	9.0%
\$200,000+	10.0%	11.6%	8.9%
Average Household Income	\$125,101	\$120,083	\$105,444
<b>2028 Households by Income</b>			
Household Income Base	3,240	14,621	29,683
<\$15,000	2.3%	5.8%	7.4%
\$15,000 - \$24,999	0.7%	2.4%	3.4%
\$25,000 - \$34,999	1.3%	2.8%	5.4%
\$35,000 - \$49,999	4.8%	5.6%	7.3%
\$50,000 - \$74,999	16.3%	16.7%	18.3%
\$75,000 - \$99,999	9.3%	11.0%	10.8%
\$100,000 - \$149,999	38.4%	29.4%	25.9%
\$150,000 - \$199,999	15.6%	13.5%	11.3%
\$200,000+	11.3%	12.9%	10.2%
Average Household Income	\$139,118	\$133,573	\$118,548
<b>2023 Owner Occupied Housing Units by Value</b>			
Total	2,359	9,946	19,814
<\$50,000	0.9%	1.2%	2.0%
\$50,000 - \$99,999	0.0%	0.3%	3.0%
\$100,000 - \$149,999	4.0%	4.4%	11.2%
\$150,000 - \$199,999	17.6%	19.4%	22.6%
\$200,000 - \$249,999	35.4%	26.6%	20.7%
\$250,000 - \$299,999	24.5%	18.0%	12.5%
\$300,000 - \$399,999	15.4%	18.7%	14.7%
\$400,000 - \$499,999	1.8%	10.0%	10.4%
\$500,000 - \$749,999	0.0%	0.9%	1.4%
\$750,000 - \$999,999	0.3%	0.5%	1.2%
\$1,000,000 - \$1,499,999	0.0%	0.2%	0.2%
\$1,500,000 - \$1,999,999	0.0%	0.0%	0.0%
\$2,000,000 +	0.0%	0.0%	0.1%
Average Home Value	\$248,262	\$271,061	\$258,912
<b>2028 Owner Occupied Housing Units by Value</b>			
Total	2,463	10,397	20,759
<\$50,000	0.1%	0.2%	0.5%
\$50,000 - \$99,999	0.0%	0.0%	0.5%
\$100,000 - \$149,999	0.6%	0.6%	2.6%
\$150,000 - \$199,999	7.2%	7.3%	13.8%
\$200,000 - \$249,999	28.2%	21.2%	21.5%
\$250,000 - \$299,999	25.1%	20.1%	15.3%
\$300,000 - \$399,999	33.0%	32.9%	25.6%
\$400,000 - \$499,999	4.7%	16.1%	16.6%
\$500,000 - \$749,999	0.0%	0.7%	1.4%
\$750,000 - \$999,999	1.0%	0.7%	2.0%
\$1,000,000 - \$1,499,999	0.0%	0.1%	0.3%
\$1,500,000 - \$1,999,999	0.0%	0.0%	0.0%
\$2,000,000 +	0.0%	0.0%	0.1%
Average Home Value	\$291,714	\$315,907	\$313,159

**Data Note:** Income represents the preceding year, expressed in current dollars. Household income includes wage and salary earnings, interest dividends, net rents, pensions, SSI and welfare payments, child support, and alimony.

**Source:** Esri forecasts for 2023 and 2028. U.S. Census Bureau 2000 and 2010 decennial Census data converted by Esri into 2020 geography.



# Market Profile

International Blvd  
 International Blvd, Laredo, Texas, 78045  
 Rings: 1, 3, 5 mile radii

Prepared by Esri  
 Latitude: 27.61363  
 Longitude: -99.46606

	1 mile	3 miles	5 miles
<b>Median Household Income</b>			
2023	\$106,836	\$99,893	\$80,137
2028	\$113,028	\$106,083	\$92,965
<b>Median Home Value</b>			
2023	\$238,772	\$246,487	\$226,809
2028	\$277,589	\$301,519	\$286,282
<b>Per Capita Income</b>			
2023	\$36,270	\$37,829	\$32,977
2028	\$41,144	\$42,928	\$37,806
<b>Median Age</b>			
2010	28.6	31.0	30.3
2020	31.2	33.6	33.0
2023	31.3	33.3	32.6
2028	30.4	33.0	32.9
<b>2020 Population by Age</b>			
Total	10,632	43,847	89,134
0 - 4	8.1%	6.4%	6.2%
5 - 9	9.1%	7.5%	7.4%
10 - 14	10.2%	8.7%	8.5%
15 - 24	15.2%	16.2%	17.4%
25 - 34	13.0%	13.2%	13.0%
35 - 44	18.7%	15.1%	13.7%
45 - 54	13.6%	14.3%	13.9%
55 - 64	6.6%	9.9%	10.1%
65 - 74	3.5%	5.6%	6.0%
75 - 84	1.6%	2.4%	2.8%
85 +	0.4%	0.9%	0.9%
18 +	66.5%	71.8%	72.4%
<b>2023 Population by Age</b>			
Total	10,878	44,937	91,602
0 - 4	8.7%	7.5%	7.5%
5 - 9	9.0%	8.4%	8.1%
10 - 14	8.4%	8.1%	8.0%
15 - 24	13.4%	13.0%	14.4%
25 - 34	16.3%	15.8%	15.8%
35 - 44	17.1%	16.4%	15.4%
45 - 54	12.7%	12.8%	12.3%
55 - 64	7.7%	9.3%	9.2%
65 - 74	4.6%	5.7%	6.0%
75 - 84	1.6%	2.4%	2.6%
85 +	0.4%	0.6%	0.7%
18 +	69.4%	71.5%	71.8%
<b>2028 Population by Age</b>			
Total	11,050	45,612	93,068
0 - 4	9.3%	8.0%	7.8%
5 - 9	9.0%	8.2%	7.9%
10 - 14	8.8%	8.2%	8.0%
15 - 24	12.8%	12.0%	13.1%
25 - 34	19.9%	17.7%	17.1%
35 - 44	15.6%	16.7%	16.1%
45 - 54	11.7%	11.8%	11.5%
55 - 64	7.0%	8.4%	8.5%
65 - 74	4.0%	5.6%	6.0%
75 - 84	1.6%	2.7%	3.1%
85 +	0.3%	0.7%	0.8%
18 +	68.5%	71.3%	72.0%
<b>2020 Population by Sex</b>			

Source: Esri forecasts for 2023 and 2028. U.S. Census Bureau 2000 and 2010 decennial Census data converted by Esri into 2020 geography.

January 31, 2024





# Market Profile

International Blvd  
International Blvd, Laredo, Texas, 78045  
Rings: 1, 3, 5 mile radii

Prepared by Esri  
Latitude: 27.61363  
Longitude: -99.46606

	1 mile	3 miles	5 miles
Males	5,237	21,318	43,007
Females	5,395	22,529	46,127
<b>2023 Population by Sex</b>			
Males	5,326	21,930	44,498
Females	5,552	23,009	47,105
<b>2028 Population by Sex</b>			
Males	5,367	22,147	45,035
Females	5,680	23,465	48,032
<b>2010 Population by Race/Ethnicity</b>			
Total	6,171	33,200	74,269
White Alone	89.9%	91.1%	89.7%
Black Alone	0.9%	0.6%	0.5%
American Indian Alone	0.3%	0.3%	0.4%
Asian Alone	1.9%	1.7%	1.3%
Pacific Islander Alone	0.0%	0.0%	0.0%
Some Other Race Alone	5.7%	5.1%	6.7%
Two or More Races	1.3%	1.2%	1.4%
Hispanic Origin	90.8%	90.6%	92.2%
Diversity Index	32.3	30.8	30.8
<b>2020 Population by Race/Ethnicity</b>			
Total	10,632	43,847	89,134
White Alone	35.7%	34.4%	34.5%
Black Alone	0.8%	0.6%	0.7%
American Indian Alone	0.5%	0.5%	0.6%
Asian Alone	1.4%	1.4%	1.1%
Pacific Islander Alone	0.0%	0.0%	0.0%
Some Other Race Alone	15.7%	14.4%	16.6%
Two or More Races	45.9%	48.6%	46.5%
Hispanic Origin	92.5%	92.4%	93.1%
Diversity Index	68.7	67.7	68.3
<b>2023 Population by Race/Ethnicity</b>			
Total	10,878	44,938	91,603
White Alone	35.3%	34.0%	34.2%
Black Alone	0.8%	0.7%	0.7%
American Indian Alone	0.5%	0.5%	0.6%
Asian Alone	1.5%	1.5%	1.2%
Pacific Islander Alone	0.0%	0.0%	0.0%
Some Other Race Alone	15.9%	14.5%	16.8%
Two or More Races	45.9%	48.7%	46.6%
Hispanic Origin	92.6%	92.7%	93.3%
Diversity Index	68.8	67.6	68.3
<b>2028 Population by Race/Ethnicity</b>			
Total	11,048	45,611	93,066
White Alone	34.4%	33.1%	33.2%
Black Alone	0.8%	0.7%	0.7%
American Indian Alone	0.6%	0.6%	0.6%
Asian Alone	1.6%	1.6%	1.3%
Pacific Islander Alone	0.1%	0.0%	0.0%
Some Other Race Alone	17.2%	15.7%	18.0%
Two or More Races	45.3%	48.3%	46.1%
Hispanic Origin	92.8%	92.9%	93.5%
Diversity Index	69.4	68.1	68.7

**Data Note:** Persons of Hispanic Origin may be of any race. The Diversity Index measures the probability that two people from the same area will be from different race/ethnic groups.

**Source:** Esri forecasts for 2023 and 2028. U.S. Census Bureau 2000 and 2010 decennial Census data converted by Esri into 2020 geography.

January 31, 2024



# Market Profile

International Blvd  
 International Blvd, Laredo, Texas, 78045  
 Rings: 1, 3, 5 mile radii

Prepared by Esri  
 Latitude: 27.61363  
 Longitude: -99.46606

	1 mile	3 miles	5 miles
<b>2020 Population by Relationship and Household Type</b>			
Total	10,632	43,847	89,134
In Households	100.0%	99.6%	98.7%
Householder	28.6%	31.2%	30.8%
Opposite-Sex Spouse	19.0%	18.8%	17.8%
Same-Sex Spouse	0.2%	0.1%	0.1%
Opposite-Sex Unmarried Partner	1.2%	1.4%	1.4%
Same-Sex Unmarried Partner	0.1%	0.1%	0.1%
Biological Child	39.1%	36.6%	35.9%
Adopted Child	0.5%	0.3%	0.3%
Stepchild	2.0%	1.6%	1.5%
Grandchild	2.2%	2.3%	2.9%
Brother or Sister	1.3%	1.3%	1.4%
Parent	2.0%	1.9%	2.0%
Parent-in-law	0.7%	0.5%	0.5%
Son-in-law or Daughter-in-law	0.5%	0.6%	0.7%
Other Relatives	1.5%	1.5%	1.7%
Foster Child	0.1%	0.1%	0.1%
Other Nonrelatives	1.2%	1.4%	1.4%
In Group Quarters	0.0%	0.4%	1.3%
Institutionalized	0.0%	0.3%	0.2%
Noninstitutionalized	0.0%	0.1%	1.1%
<b>2023 Population 25+ by Educational Attainment</b>			
Total	6,573	28,331	56,874
Less than 9th Grade	4.6%	4.1%	5.3%
9th - 12th Grade, No Diploma	7.9%	6.0%	8.2%
High School Graduate	16.5%	16.3%	17.2%
GED/Alternative Credential	1.6%	3.0%	3.4%
Some College, No Degree	8.1%	13.8%	16.2%
Associate Degree	13.0%	11.7%	10.3%
Bachelor's Degree	36.9%	32.2%	28.4%
Graduate/Professional Degree	11.4%	12.9%	11.1%
<b>2023 Population 15+ by Marital Status</b>			
Total	8,027	34,165	70,030
Never Married	35.9%	31.1%	34.2%
Married	57.4%	59.6%	55.7%
Widowed	1.3%	3.1%	3.4%
Divorced	5.4%	6.1%	6.8%
<b>2023 Civilian Population 16+ in Labor Force</b>			
Civilian Population 16+	5,414	22,343	45,141
Population 16+ Employed	99.5%	98.3%	97.3%
Population 16+ Unemployment rate	0.5%	1.7%	2.7%
Population 16-24 Employed	10.3%	9.6%	12.0%
Population 16-24 Unemployment rate	0.7%	5.7%	8.1%
Population 25-54 Employed	80.2%	73.8%	70.6%
Population 25-54 Unemployment rate	0.4%	1.0%	1.8%
Population 55-64 Employed	7.5%	11.7%	12.6%
Population 55-64 Unemployment rate	0.2%	0.6%	1.3%
Population 65+ Employed	2.0%	4.9%	4.8%
Population 65+ Unemployment rate	1.8%	6.7%	5.5%

Source: Esri forecasts for 2023 and 2028. U.S. Census Bureau 2000 and 2010 decennial Census data converted by Esri into 2020 geography.

January 31, 2024



# Market Profile

International Blvd  
 International Blvd, Laredo, Texas, 78045  
 Rings: 1, 3, 5 mile radii

Prepared by Esri  
 Latitude: 27.61363  
 Longitude: -99.46606

	1 mile	3 miles	5 miles
<b>2023 Employed Population 16+ by Industry</b>			
Total	5,389	21,952	43,901
Agriculture/Mining	1.4%	1.5%	1.6%
Construction	9.5%	4.4%	3.7%
Manufacturing	3.7%	2.3%	2.6%
Wholesale Trade	1.8%	3.7%	3.5%
Retail Trade	7.1%	6.5%	8.0%
Transportation/Utilities	13.0%	18.1%	21.4%
Information	0.5%	1.0%	1.0%
Finance/Insurance/Real Estate	3.8%	5.5%	5.6%
Services	45.6%	44.8%	42.0%
Public Administration	13.6%	12.1%	10.7%
<b>2023 Employed Population 16+ by Occupation</b>			
Total	5,388	21,951	43,900
White Collar	66.5%	70.7%	67.6%
Management/Business/Financial	17.4%	20.2%	19.6%
Professional	33.3%	28.2%	23.6%
Sales	5.9%	8.6%	9.9%
Administrative Support	9.9%	13.7%	14.5%
Services	20.7%	16.3%	16.1%
Blue Collar	12.7%	13.0%	16.3%
Farming/Forestry/Fishing	0.0%	0.0%	0.0%
Construction/Extraction	5.8%	3.9%	3.4%
Installation/Maintenance/Repair	1.0%	1.4%	2.3%
Production	1.3%	1.7%	1.7%
Transportation/Material Moving	4.5%	5.9%	8.9%
<b>2020 Households by Type</b>			
Total	3,020	13,610	27,518
Married Couple Households	66.7%	61.0%	58.1%
With Own Children <18	44.5%	33.2%	30.0%
Without Own Children <18	22.2%	27.8%	28.1%
Cohabiting Couple Households	4.7%	4.6%	4.9%
With Own Children <18	2.7%	2.2%	2.4%
Without Own Children <18	2.0%	2.4%	2.5%
Male Householder, No Spouse/Partner	11.6%	13.2%	13.6%
Living Alone	6.5%	7.6%	7.7%
65 Years and over	0.6%	1.1%	1.4%
With Own Children <18	2.4%	1.9%	1.8%
Without Own Children <18, With Relatives	2.2%	2.8%	3.2%
No Relatives Present	0.6%	0.9%	0.8%
Female Householder, No Spouse/Partner	17.0%	21.2%	23.5%
Living Alone	5.1%	7.1%	7.7%
65 Years and over	1.2%	2.5%	3.3%
With Own Children <18	6.5%	6.5%	7.4%
Without Own Children <18, With Relatives	5.4%	7.1%	7.8%
No Relatives Present	0.1%	0.4%	0.5%
<b>2020 Households by Size</b>			
Total	3,020	13,610	27,518
1 Person Household	11.5%	14.7%	15.5%
2 Person Household	17.3%	23.0%	23.3%
3 Person Household	19.8%	18.9%	18.9%
4 Person Household	25.5%	22.2%	20.8%
5 Person Household	15.7%	12.5%	12.8%
6 Person Household	5.8%	5.4%	5.4%
7 + Person Household	4.3%	3.2%	3.4%

Source: Esri forecasts for 2023 and 2028. U.S. Census Bureau 2000 and 2010 decennial Census data converted by Esri into 2020 geography.

January 31, 2024



# Market Profile

International Blvd  
 International Blvd, Laredo, Texas, 78045  
 Rings: 1, 3, 5 mile radii

Prepared by Esri  
 Latitude: 27.61363  
 Longitude: -99.46606

	1 mile	3 miles	5 miles
<b>2020 Households by Tenure and Mortgage Status</b>			
Total	3,020	13,610	27,518
Owner Occupied	86.5%	75.0%	70.1%
Owned with a Mortgage/Loan	77.5%	58.3%	51.7%
Owned Free and Clear	8.9%	16.7%	18.3%
Renter Occupied	13.5%	25.0%	29.9%
<b>2023 Affordability, Mortgage and Wealth</b>			
Housing Affordability Index	153	140	122
Percent of Income for Mortgage	13.4%	14.8%	17.0%
Wealth Index	96	100	86
<b>2020 Housing Units By Urban/ Rural Status</b>			
Total	3,111	14,260	29,008
Urban Housing Units	99.9%	100.0%	99.4%
Rural Housing Units	0.1%	0.0%	0.6%
<b>2020 Population By Urban/ Rural Status</b>			
Total	10,632	43,847	89,134
Urban Population	99.8%	99.9%	99.3%
Rural Population	0.2%	0.1%	0.7%

**Data Note:** Households with children include any households with people under age 18, related or not. Multigenerational households are families with 3 or more parent-child relationships. Unmarried partner households are usually classified as nonfamily households unless there is another member of the household related to the householder. Multigenerational and unmarried partner households are reported only to the tract level. Esri estimated block group data, which is used to estimate polygons or non-standard geography.

**Source:** Esri forecasts for 2023 and 2028. U.S. Census Bureau 2000 and 2010 decennial Census data converted by Esri into 2020 geography.



# Market Profile

International Blvd  
 International Blvd, Laredo, Texas, 78045  
 Rings: 1, 3, 5 mile radii

Prepared by Esri  
 Latitude: 27.61363  
 Longitude: -99.46606

	1 mile	3 miles	5 miles
<b>Top 3 Tapestry Segments</b>			
1.	Up and Coming Families (7A)		
2.	Boomburbs (1C)		Boomburbs (1C)
3.	Enterprising Professionals		Urban Villages (7B)
<b>2023 Consumer Spending</b>			
Apparel & Services: Total \$	\$8,134,813	\$34,782,605	\$61,875,554
Average Spent	\$2,601.48	\$2,462.83	\$2,159.55
Spending Potential Index	118	112	98
Education: Total \$	\$5,631,192	\$26,405,087	\$47,634,371
Average Spent	\$1,800.83	\$1,869.65	\$1,662.51
Spending Potential Index	100	104	93
Entertainment/Recreation: Total \$	\$13,978,422	\$59,807,227	\$105,901,693
Average Spent	\$4,470.23	\$4,234.74	\$3,696.14
Spending Potential Index	118	112	98
Food at Home: Total \$	\$23,774,231	\$101,901,610	\$183,561,957
Average Spent	\$7,602.89	\$7,215.29	\$6,406.60
Spending Potential Index	112	106	94
Food Away from Home: Total \$	\$14,416,947	\$60,933,574	\$107,798,783
Average Spent	\$4,610.47	\$4,314.49	\$3,762.35
Spending Potential Index	124	116	101
Health Care: Total \$	\$26,209,003	\$110,887,682	\$197,401,456
Average Spent	\$8,381.52	\$7,851.57	\$6,889.62
Spending Potential Index	114	107	94
HH Furnishings & Equipment: Total \$	\$11,131,335	\$47,495,819	\$84,076,653
Average Spent	\$3,559.75	\$3,363.01	\$2,934.41
Spending Potential Index	120	114	99
Personal Care Products & Services: Total \$	\$3,556,316	\$15,217,961	\$27,110,100
Average Spent	\$1,137.29	\$1,077.53	\$946.19
Spending Potential Index	119	113	99
Shelter: Total \$	\$89,732,525	\$388,138,614	\$698,815,934
Average Spent	\$28,696.04	\$27,482.73	\$24,389.78
Spending Potential Index	116	111	98
Support Payments/Cash Contributions/Gifts in Kind: Total \$	\$12,135,913	\$51,171,978	\$89,213,447
Average Spent	\$3,881.01	\$3,623.31	\$3,113.69
Spending Potential Index	124	116	100
Travel: Total \$	\$8,549,867	\$37,171,189	\$65,690,366
Average Spent	\$2,734.21	\$2,631.96	\$2,292.70
Spending Potential Index	122	117	102
Vehicle Maintenance & Repairs: Total \$	\$5,025,237	\$20,838,994	\$36,873,294
Average Spent	\$1,607.05	\$1,475.54	\$1,286.94
Spending Potential Index	123	113	98

**Data Note:** Consumer spending shows the amount spent on a variety of goods and services by households that reside in the area. Expenditures are shown by broad budget categories that are not mutually exclusive. Consumer spending does not equal business revenue. Total and Average Amount Spent Per Household represent annual figures. The Spending Potential Index represents the amount spent in the area relative to a national average of 100.

**Source:** Consumer Spending data are derived from the 2019 and 2020 Consumer Expenditure Surveys, Bureau of Labor Statistics. Esri.

**Source:** Esri forecasts for 2023 and 2028. U.S. Census Bureau 2000 and 2010 decennial Census data converted by Esri into 2020 geography.

January 31, 2024

**DISCLAIMER:** The information contained herein was obtained from sources believed reliable. However, Durhman & Bassett Realty Group, Inc. makes no guarantees, warranties or representations as to the completeness or accuracy thereof. The presentation of this property is submitted subject to errors, omissions, change of price, prior sale or lease, or withdrawal without notice.

### **INFORMATION ABOUT REAL ESTATE BROKERS**

Before working with a real estate broker, you should know that the duties of a broker depend on whom the broker represents. If you are a prospective seller or landlord (owner) or a prospective buyer or tenant (buyer), you should know that the broker who lists the property for sale or lease is the owner's agent. A broker who acts as a subagent represents the owner in cooperation with the listing broker. A broker who acts as a buyer's agent represents the buyer. A broker may act as an intermediary between the parties if the parties consent in writing. A broker can assist you in locating a property, preparing a contract or lease, or obtaining financing without representing you. A broker is obligated by law to treat you fairly.

**IF THE BROKER REPRESENTS THE OWNER:** The broker becomes the owner's agent by entering into an agreement with the owner, usually through a written listing agreement, or by agreeing to act as a subagent by accepting an offer of subagency from the listing broker. A subagent may work in a different real estate office. A listing broker or subagent can assist the buyer but does not represent the buyer and must place the interests of the owner first. The buyer should not tell the owner's agent anything the buyer would not want the owner to know because an owner's agent must disclose to the owner any material information known to the agent.

**IF THE BROKER REPRESENTS THE BUYER:** The broker becomes the buyer's agent by entering into an agreement to represent the buyer, usually through a written buyer representation agreement. A buyer's agent can assist the owner but does not represent the owner and must place the interests of the buyer first. The owner should not tell a buyer's agent anything the owner would not want the buyer to know because the buyer's agent must disclose any material information known to the agent.

**IF THE BROKER ACTS AS AN INTERMEDIARY:** A broker may act as an intermediary between the parties if the broker complies with The Texas Real Estate License Act. The broker must obtain the written consent of each party to the transaction to act as an intermediary. The written consent must state who will pay the broker and, in conspicuous bold or underlined print, set forth the broker's obligations as an intermediary. The broker is required to treat each party honestly and fairly and to comply with The Texas Real Estate License Act. A broker who acts as an intermediary in a transaction: (1) shall treat all parties honestly; (2) may not disclose that the owner will accept a price less than the asking price unless authorized in writing to do so by the owner; (3) may not disclose that the buyer will pay a price greater than the price submitted in a written offer unless authorized in writing to do so by the buyer; (4) may not disclose any confidential information or any information that a party specifically instructs the broker in writing not to disclose unless authorized in writing to disclose the information or required to do so by The Texas Real Estate License Act or a court order or if the information materially relates to the condition of the property. With the parties' consent, a broker acting as an intermediary between the parties may appoint a person who is licensed under The Texas Real Estate License Act and associated with the broker to communicate with and carry out instructions of one party and another person who is licensed under that Act and associated with the broker to communicate with and carry out instructions of the other party.

If you choose to have a broker represent you, you should enter into a written agreement with the broker that clearly establishes the broker's obligations and your obligations. The agreement should state how and by whom the broker will be paid. You have the right to choose the type of representation, if any, you wish to receive. Your payment of a fee to a broker does not necessarily establish that the broker represents you. If you have any questions regarding the duties and responsibilities of the broker, you should resolve those questions before proceeding.